

SCC-F Sample gas feed unit

Operator's manual

42/23-51 EN Rev. 3



	Page
	3
Chapter 1	Safety information 4
	Intended application, instrument designs 4
	General safety information 5
	Safety tips for handling electronic measurement devices 6
Chapter 2	Preparing the installation 7
	Requirements for the installation site 7
	Power supply 8
	Sample gas inlet conditions 8
	Scope of delivery 8
Chapter 3	Installation and start-up 9
	Installing the sample gas feed unit 9
	Installing the sample gas feed unit and sample gas cooler side-by-side 11
	Connecting the electrical leads: Notes 14
	Connecting the electrical leads: SCC-F without I/O card 15
	Connecting the electrical leads: SCC-F with I/O card 18
	Setting up the I/O card in the gas analyzer 22
	Connecting the sample gas pipes 22
	Power supply activation, lead time 23
Chapter 4	Maintenance 24
	Replacing the dosing pump hose 24
	Replacing the dosing pump pressure rollers and springs 26
	Replacing the diaphragm and valve plates in the diaphragm pump 28
	Checking the gas paths for leaks 31
	Troubleshooting 31
Chapter 5	Shutting down and packing 32
	Shutting down the sample gas feed unit 32
	Packing the sample gas feed unit 33
Appendix	34
	Use and functions of the sample gas feed unit 34
	Description 35
	Pneumatic diagrams 36
	I/O card 38
	Operating specifications 39
	Index 40

Preface

Content of the operator's manual

This operator's manual contains all the information you will need to safely and efficiently install, start-up, operate and maintain the SCC-F sample gas feed unit.

This operator's manual contains information on all the functional units in the sample gas feed unit. The delivered sample gas feed unit may differ from the version described.

Further information on the Internet

You can find further information on ABB Analytical products and services on the internet: "<http://www.abb.com/analytical>".

Additional information

If the information in this operator's manual does not cover a particular situation, ABB Service will be pleased to supply additional information as required.

Please contact your local service representative. For emergencies, please contact

ABB Service,

Telephone: +49-(0)180-5-222580, Telefax: +49-(0)621-38193129031,

E-mail: automation.service@de.abb.com

Symbols and typefaces



Identifies safety information to be heeded during unit operation in order to avoid risks to the operator.



Identifies specific information on operation of the unit as well as on the use of this manual.

1, 2, 3, ... Identifies reference numbers in the figures.

This operator's manual is protected by copyright. The translation, duplication and distribution in any form, even in a revised edition or in extracts, in particular as a reprint, by photomechanical or electronic reproduction or in the form of storage in data processing systems or data networks are prohibited without the consent of the copyright holder and will be prosecuted under civil and criminal law.

Intended application, instrument designs

Intended application	<p>The SCC-F sample gas feed unit is designed for continuous dosed feeding of sample gas.</p> <p>The SCC-F sample gas feed unit must not be used</p> <ul style="list-style-type: none">• for feeding mixtures of gas/air or gas/oxygen that are capable of ignition during normal service,• for feeding flammable gas, which can combine with air or oxygen to form an ignition-capable mixture, or• in a potentially explosive atmosphere or in hazardous areas.
Standard model	<p>The sample gas feed unit is intended for installation in non-hazardous areas. It complies with EN 61010 Part 1 “Safety requirements for electrical equipment for measurement, control and laboratory use” and with standards CAN/CSA-C22.2 No. 61010-1-12 and UL Std. No. 61010-1 (3rd Edition).</p> <p>Certificate no. 70010607.</p>
Version for Class I, Div. 2	<p>The sample gas feed unit is certified to</p> <ul style="list-style-type: none">• Class 2258 02 Process Control Equipment – For Hazardous Locations – Certified to Canadian Standards and• Class 2258 82 Process Control Equipment – For Hazardous Locations – Certified to U.S. Standards <p>for use in hazardous areas Class I, Division 2, Groups A, B, C and D, temperature code T4, ambient temperature max. +50 °C.</p> <p>The approval includes the testing in accordance with the relevant Canadian CSA and US American guidelines.</p> <p>Certificate no. 1105720.</p>
Details on the rating plate	<p>The details on the rating plate are applicable for the version of the sample gas feed unit.</p>

General safety information

Requirements for safe operation	In order to operate in a safe and efficient manner the unit should be properly handled and stored, correctly installed and started, properly operated and carefully maintained.
Personnel qualifications	Only persons familiar with the installation, set-up, operation and maintenance of comparable equipment and certified as being capable of such work should work on the unit.
Important notes and regulations	<p>It is important to comply with:</p> <ul style="list-style-type: none">• The content of this operator's manual• The safety information affixed to the unit• The applicable safety precautions for installing and operating electrical devices• Safety precautions for working with gases, acids, condensates, etc.
National regulations	The regulations, standards and guidelines cited in this operator's manual are applicable in the Federal Republic of Germany. The applicable national regulations should be followed when the unit is used in other countries.
Unit safety and safe operation	<p>The unit is designed and tested in accordance with EN 61010 Part 1, "Safety provisions for electrical measuring, control, and laboratory instruments" and has been shipped ready for safe operation.</p> <p>To maintain this condition and to assure safe operation, read and follow the safety information identified with the  symbol in this manual. Failure to do so can put persons at risk and can lead to unit damage as well as damage to other systems and instruments.</p>

Safety tips for handling electronic measurement devices

Protective lead connection	The protective lead should be attached to the protective lead connector before any other connection is made.
Risks of loss of protective lead continuity	The unit can be hazardous if the protective lead is interrupted inside or outside the unit or if the protective lead is disconnected.
Proper operating voltage	The unit voltage must be set to match the line voltage before the power supply is activated.
Risks involved in opening the covers	Current-bearing components can be exposed when the covers or parts are removed, even if this can be done without tools. Current can be present at some connection points.
Risks involved in working with an open unit	The unit must be disconnected from all power sources before any maintenance work is performed.
Charged capacitors	The unit capacitors can retain their charge even when the unit is disconnected from all power sources.
Use of proper fuses	Only fuses of the specified type and rated current should be used as replacements. Never use patched fuses. Do not short-circuit the fuse holder contacts.
When safe operation can no longer be assured	<p>If it is apparent that safe operation is no longer possible, the unit should be taken out of operation and secured against unauthorized use.</p> <p>The possibility of safe operation is excluded:</p> <ul style="list-style-type: none">• If the unit is visibly damaged• If the unit is no longer operational• After prolonged storage under adverse conditions• After severe transport stresses.
WARNING EXPLOSION HAZARD	<p>Substitution of components may impair suitability for Class I, Division 2.</p> <p>Do not disconnect equipment unless power has been switched off or the area is known to be non-hazardous.</p> <p>I/O connectors must only be connected to Class 2 circuits.</p>

Requirements for the installation site

Installation location requirements	<p>The sample gas feed unit is only intended for installation indoors.</p> <p>The max. altitude of the installation site may not exceed 2000 m above sea level.</p> <p>The installation site must be stable enough to bear the weight of the sample gas feed unit (max. 15 kg)!</p>	
Short gas paths	<p>The sample gas feed unit should be installed as close as possible to the gas analyzer.</p>	
Adequate air circulation	<p>Ensure adequate natural air circulation around the sample gas feed unit. Avoid heat accumulation.</p>	
Protection against adverse environmental conditions	<p>The sample gas feed unit should be protected from</p> <ul style="list-style-type: none"> • Cold, • Radiated heat, e.g. from the sun, kilns or boilers, • Temperature fluctuations, • Strong air movement, • Dust deposits and dust penetration, • Corrosive atmosphere, • Vibration. 	
Climatic conditions	Ambient temperature	<p>In operation: +5 to +45 °C</p> <p>Storage and transport: –25 to +60 °C</p>
	Relative humidity	<p>≤ 75 % year-round average, ≤ 95 % on 30 days per year, occasional light condensation permissible</p>

Power supply

Power supply	Input voltage	230 V AC or 115 V AC, 50 Hz or 60 Hz
	Power consumption	max. 185 VA

Sample gas inlet conditions

Sample gas inlet conditions	Sample gas pressure	$p_{\text{abs}} = 70$ to 105 kPa (0.7 to 1.05 bar)
	Sample gas flow	Gas paths 1 and 2 max. 100 l/h, bypass max. 200 l/h
	Sample gas inlet temperature	+10 to +50°C
	Sample gas inlet dew point	The dew point of the sample gas must be at least 5 °C lower than the lowest ambient temperature anywhere in the sample gas feed path. If this is not the case, then a sample gas cooler unit or a condensate trap is required.

Scope of delivery

Scope of delivery	Quantity	Description
	1	SCC-F sample gas feed unit
	2	Operator's manuals (1 copy in German, 1 in English)
	8	Fastening screws M5 x 12 (4 x recessed head, 4 x hexagon socket; for installing side-by-side with the SCC-C sample gas cooler)
	1	Rubber bushing with 18 mm inside diameter (for the cables to/from the SCC-C sample gas cooler)
	1	Power supply connection cable, 3-conductor, length approx. 50 cm
	1	Connection cable, 2-conductor, length approx. 40 cm



The fixing brackets are fitted in the factory.

-  • If there is shipping damage which points to improper handling, file a damage claim with the shipper (railway, mail or freight carrier) within seven days.
- Make sure that none of the enclosed accessories are lost during unpacking (see section “Scope of delivery”, page 8).
- Keep the shipping box and packaging material for future shipping needs.

Installing the sample gas feed unit

Figure 1
Dimensional drawing:
Sample gas feed unit
 (Dimensions in mm)

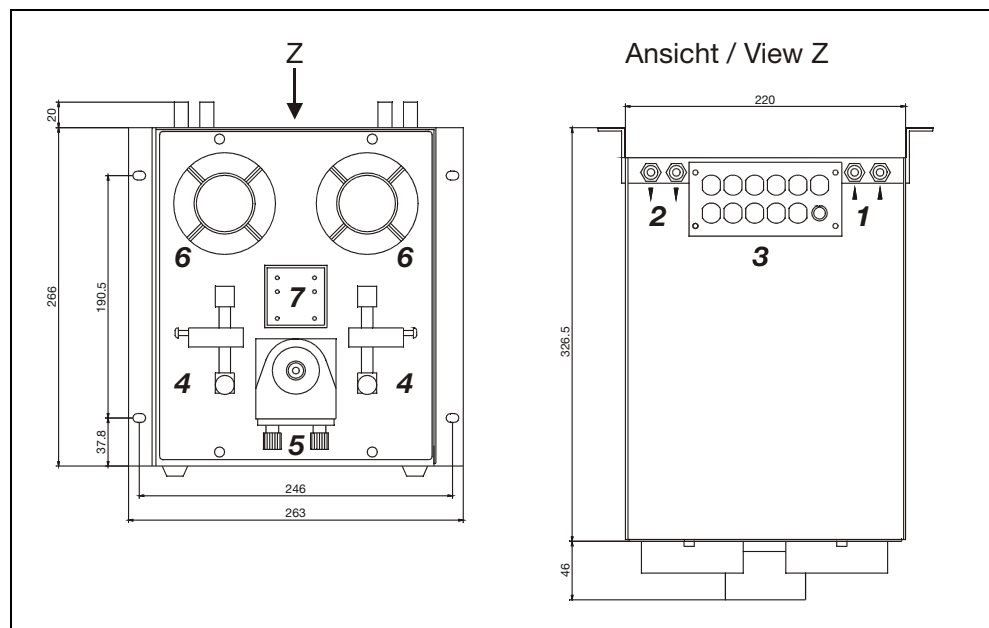

- | | |
|---|---|
| 1 Sample gas inlet | 5 Dosing pump |
| 2 Sample gas outlet | 6 Condensate monitor |
| 3 Cable bushings | 7 LED display and reset switch for condensate and flow alarm |
| 4 Flow monitor with needle valve | |

-  • You must take the additional space requirement into account
 - adjacent to the unit on the left-hand side for the cooling air inlet (approx. 10 cm),
 - in front of and underneath the unit for running and connecting the reagent pipes to the dosing pump (option) and
 - above the unit for running and connecting the sample gas lines and the electrical leads.
- The fixing brackets are fitted in the factory, with about 2.5 cm projection to the rear wall. This projection must not be reduced.
- Slope max. 5°.
- The user is responsible for the secure mounting of the unit.
- Figure 1 shows options. The scope and features of the ordered version may differ.

Continued on next page

 Installation of the sample gas feed unit and the sample gas cooler side-by-side is described on page 11.

Sample gas feed unit installation on a mounting plate

Step	Action
1	Fit the unit to the mounting plate using 4 M6 screws (not supplied). The fixing brackets required for this purpose are screwed securely on the rear of the side panels in the factory.  To enable the cooling air to pass unobstructed out of the unit to the rear, the projection of the fixing brackets of around 2.5 cm to the rear wall, which is set up in the factory, must not be reduced.

Sample gas feed unit installation in a 19-inch cabinet/rack

Step	Action
1	Unscrew the mounting brackets from the rear of the side covers and screw them securely at the front of the side covers, flush with the front cover, using the drill holes provided for this purpose.
2	Install the unit in a 19-inch cabinet/rack using 4 M6 screws.

Release the diaphragm pumps transportation restraints

Step	Action
1	Use a Ph2 crosshead screwdriver to loosen the two M6x25 screws in the base plate.  Retain the screws in case the unit needs to be transported again in the future.

Installing the sample gas feed unit and sample gas cooler side-by-side

Installing the sample gas feed unit and sample gas cooler side-by-side

The best way to install the SCC-F feed unit and the SCC-C cooler unit in a 19-inch cabinet or a 19-inch rack is side-by-side. In this case, the sample gas feed unit should be installed on the left and the cooler unit on the right (see Figure 2).



“Right”, “left” etc. should always be interpreted from a position facing towards the unit’s front panel.

Figure 2

Dimensional drawing: Sample gas feed unit and sample gas cooler side-by-side

(Dimensions in mm)

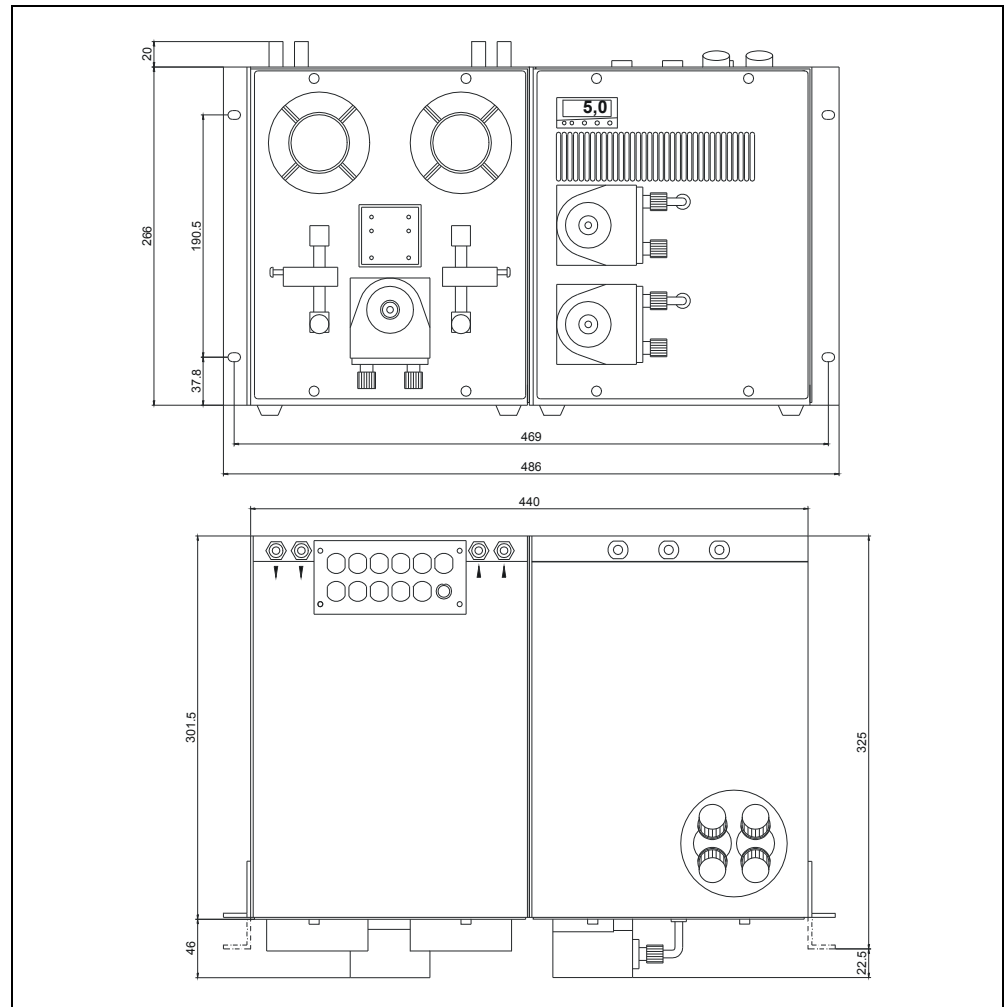

- You must take the additional space requirement into account
 - adjacent to the units on the right-hand and left-hand side for the cooling air inlet and in front of the units for the cooling air outlet (approx. 10 cm in each case),
 - in front of and underneath the units for running and connecting the condensate and reagent pipes and
 - above the units for running and connecting the sample gas lines and the electrical leads.
- Slope max. 5°.
- The user is responsible for the secure mounting of the units.

Continued on next page

Installing the sample gas feed unit and sample gas cooler side-by-side, *continued*

Install the sample gas feed unit and sample gas cooler side-by-side



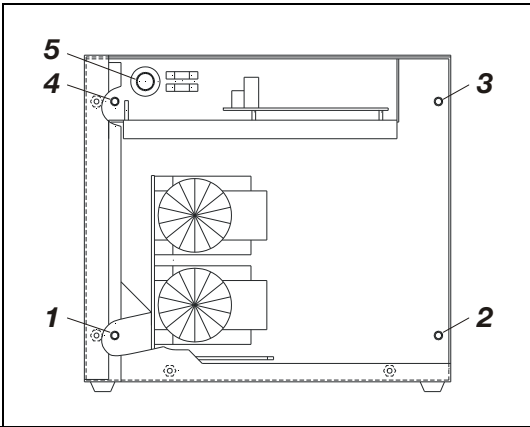

(see Figure 2)

Step	Action
Prepare sample gas feed unit for installation:	
1	Unscrew the right-hand fixing bracket.
2	Undo the 4 fastening screws on the front panel and open it forwards (the front panel remains attached in the rebate of the base plate).
3	Undo the 6 fastening screws on the casing cover, release the cable lug of the protective lead from the quick terminal on the inside of the casing cover, then remove the casing cover.
4	Undo the 6 fastening screws on the left-hand casing panel, release the cable lug of the protective lead from the quick terminal on the inside of the casing panel, then remove the casing panel.
5	Remove the dummy plug from the drill hole in the right-hand casing panel.
Prepare sample gas cooler for installation:	
6	Unscrew the left-hand fixing bracket.
7	Undo the 4 fastening screws on the front panel and open it forwards (the front panel remains attached in the rebate of the base plate).
8	Undo the 8 fastening screws on the covering hood, release the cable lug of the protective leads from the quick terminal on the inside of the covering hood, then lift the covering hood off.
9	Remove the dummy plug from the drill hole in the left-hand casing panel.
Screw sample gas feed unit and sample gas cooler together:	
10	From inside the unit, insert one of the M5x12 screws (supplied with sample gas feed unit) into the lower rear drill hole 1 in the sample gas feed unit's right-hand side panel. Press on the screw with a screw-driver, push the casings together, and screw the screw into the lower rear threaded hole in the sample gas cooler's left-hand side panel.
	
<p>Sample gas feed unit viewed from the left</p> <p>1 – Holes for screws M5x12</p> <p>2 – Hole for cable bushing</p>	
11	Again from inside the unit, screw the remaining 3 M5x12 screws through holes 2 – 4 in the sample gas feed unit's right-hand side panel into the corresponding threaded holes in the sample gas cooler's left-hand side panel. Make sure that the casings are aligned precisely relative to one another, then tighten all 4 screws.
12	Insert the rubber bushing in the hole 5 .

Continued on next page

Installing the sample gas feed unit and sample gas cooler side-by-side, *continued*

Install the sample gas feed unit and sample gas cooler side-by-side
(*continued*)

Step	Action
Connect electrical leads:	
13	Connect the signal, control and power supply leads. SCC-F without I/O card: see instructions on page 15, SCC-F with I/O card: see instructions on page 18.
Close casings of sample gas feed unit and sample gas cooler:	
14	Replace and secure the sample gas cooler's covering hood as well as the sample gas feed unit's left-hand casing panel and casing cover; in the course of this operation, the cable lugs of the protective leads should be pushed back onto the quick terminals. Close and secure the front panels.  Take care not to squash any cables or hoses.
Installing the sample gas feed unit/sample gas cooler combination:	
15	 Two people are required to transport and install the feed/cooler unit combination. Fitting in a 19-inch cabinet/rack: Unscrew the fixing brackets from the rear of the side panels and screw them securely at the front of the side panels using the drill holes provided for this purpose. Fit the feed/cooler unit combination to the wall using 4 M6 screws (not supplied). Fitting to a mounting plate: Fit the feed/cooler unit combination using 4 M6 screws (not supplied). The fixing brackets required for this purpose are screwed securely on the rear of the side panels in the factory.  To enable the cooling air to pass unobstructed out of the sample gas feed unit and sample gas cooler to the rear, the projection of the fixing brackets of around 2.5 cm to the rear wall, which is set up in the factory, must not be reduced.
Release the diaphragm pumps and compressor transportation restraints	
16	Use a Ph2 crosshead screwdriver to loosen the two M6x25 screws in the sample gas feed unit's base plate.  Retain the screws in case the unit needs to be transported again in the future.
17	Using a Ph2 crosshead screwdriver, turn the two screws counter-clockwise through the sample gas cooler's base plate up to the point at which resistance can be felt.

Connecting the electrical leads: Notes



CAUTION!

Follow all applicable national safety regulations for the installation and operation of electrical devices as well as the following safety precautions.

The sample gas feed unit voltage must be set to match the line voltage before the power supply is connected (see rating plate).

The protective lead should be attached to the protective lead connector before any other connection is made.

The sample gas feed unit can be hazardous if the protective lead is interrupted inside or outside the sample gas feed unit or if the protective lead is disconnected.



You should route the signal lines separately from the power supply lines.

Control of the diaphragm pumps

The internal control of the diaphragm pumps is dependent on the positions of jumpers JP1 and JP2 (see below; see also Figure 4).

For maintenance purposes it is also possible to switch the pumps off using external switches (see Figure 3)

Internal control of the diaphragm pumps

Jumper	Open (factory setting)	Closed
JP1	Condensate alarm 1 switches off diaphragm pump 1	Condensate alarm 1 does not switch off diaphragm pump 1
JP2	Condensate alarm 2 switches off diaphragm pump 2	Condensate alarm 2 does not switch off diaphragm pump 2

Connection of the sample gas cooler to the sample gas feed unit

If the SCC-F sample gas feed unit and the SCC-C sample gas cooler are used together (e.g. in an analysis system), the electrical leads from the sample gas cooler can be connected to the sample gas feed unit:

- Temperature monitoring status signal (temperature alarm, in SCC-F without I/O card),
- Pt 100 resistance thermometer signal (temperature monitoring, in SCC-F with I/O card),
- Power supply.

In the event of a temperature alarm in the sample gas cooler the diaphragm pumps in the sample gas feed unit are switched off.





Sample gas feed unit with I/O card

The sample gas feed unit with integral I/O card is connected to the system bus of the AO2000 Series gas analyzers. In this case it may be necessary (this depends on the system bus layout) to interrupt the internal system bus connection between the analyzer module and the electronics module in the analyzer. For detailed information refer to the section "System bus connection" in the "AO2000 Series" operator's manual (Document No. 42/24-10 EN).

Connecting the electrical leads: SCC-F without I/O card

Connecting the electrical leads

(see Figures 3, 4 and 5)

Step	Action
Connect signal and control leads to the sample gas feed unit:	
1	Connect the status signal leads of the condensate and flow monitoring to terminal strip X3 .
2	If necessary connect the external control leads (230 VAC, max. 1 A) of the diaphragm pumps and the dosing pump to terminal strip X4 .  Before connecting the leads remove the factory-installed wire jumpers from the respective terminals. Do not remove the wire jumpers from the unused terminals.
If necessary connect the sample gas cooler to the sample gas feed unit:	
3	Side-by-side installation: Pull the connection cables for temperature alarm and power supply of the sample gas cooler (delivered with the unit, see section "Scope of delivery", page 8) through the rubber bushing.
4	Connect the 2-wire connection cable for the temperature alarm <ul style="list-style-type: none"> • to terminals 4 and 8 on terminal strip X4 in the sample gas feed unit and • to terminals 2 and 3 on terminal strip X3 in the sample gas cooler.  If the sample gas cooler is provided with a signal cable wires 2 (C) and 3 (NO) of this cable can be used for this purpose.
5	Connect the 3-wire connection cable for the sample gas cooler's power supply <ul style="list-style-type: none"> • to terminals 1, 2 and 3 on terminal strip X1 in the sample gas feed unit and • to terminals 2, 3 and 4 on terminal strip X1 in the sample gas cooler.  If the sample gas cooler is provided with a power supply cable this cable can be used to connect the sample gas feed unit to the power supply (see step 9).
Connect the power supply to the sample gas feed unit::	
6	 Make sure the voltage setting shown on the rating plate matches the line voltage.
7	Make sure the power supply leads have an adequately dimensioned protective device (breaker).
8	Install a switched outlet or a breaker in the power supply wiring near the sample gas feed unit. This should allow the sample gas feed unit to be completely disconnected from the power supply if necessary. The disconnection device should be identified in such a way that its relationship to the equipment that it is designed to disconnect can be clearly seen.
9	Connect the power supply leads to terminals 4, 5 and 6 on terminal strip X1 .
10	Connect the power supply leads to the power supply.  The sample gas feed unit may start when the power supply is connected.

Continued on next page

Figure 3

Connection diagram:
Sample gas feed unit
without I/O card

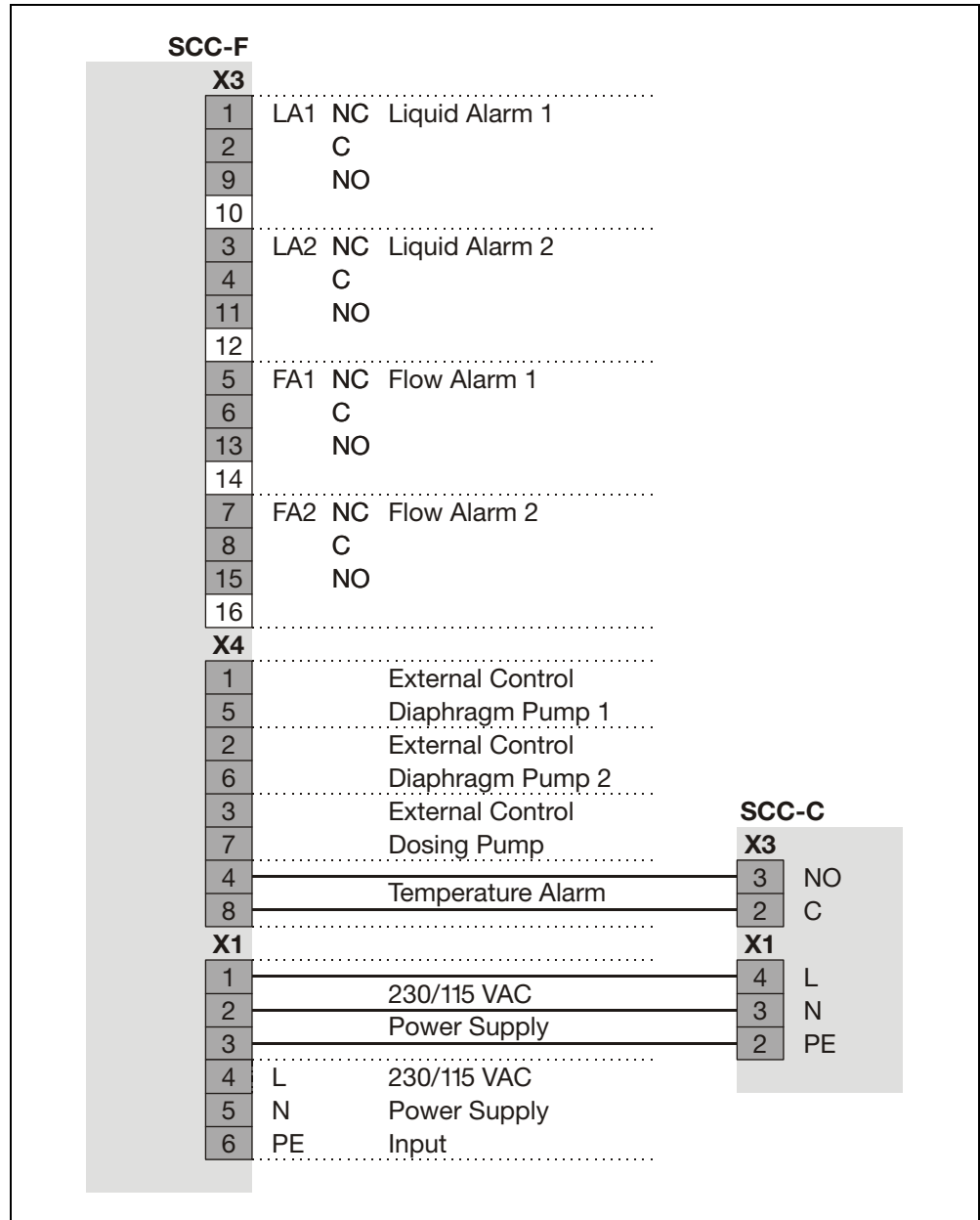

Continued on next page

Figure 4

Terminal strip positions in the sample gas feed unit without I/O card

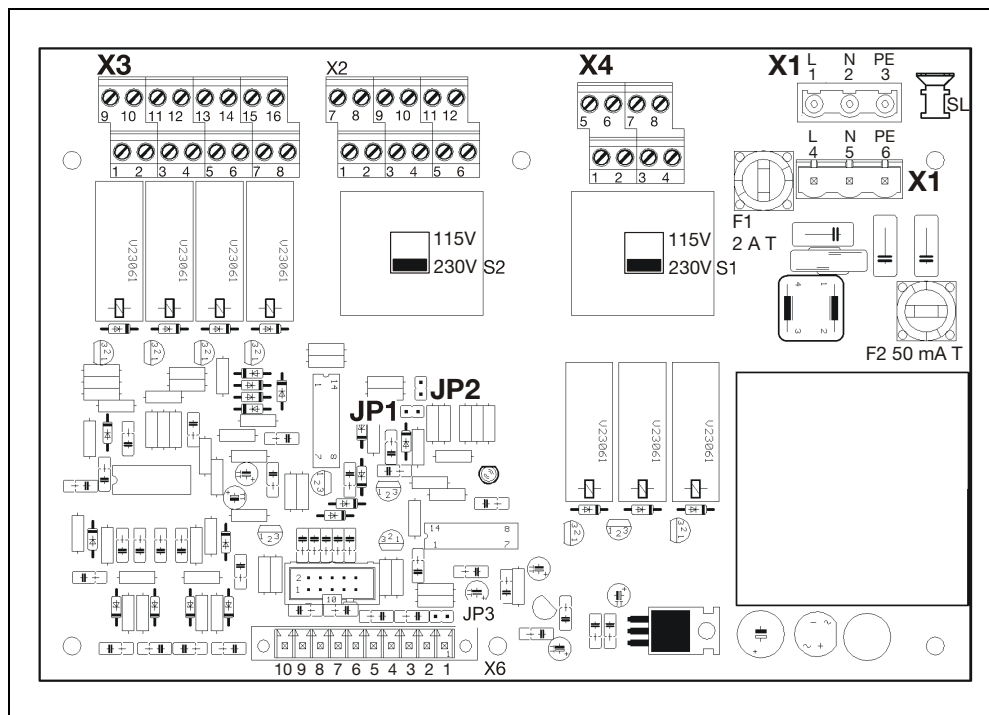

- X1** Power supply input and output (to SCC-C sample gas cooler)
- X2** Power supply of the pumps (internal connections)
- X3** Status signals of the condensate and flow monitoring
- X4** External control of the diaphragm pumps and dosing pump; temperature alarm
- X6** Condensate sensors 1 and 2, flow sensors 1 and 2 (internal connections)
- JP1** Internal control of diaphragm pump 1
- JP2** Internal control of diaphragm pump 2

Figure 5

Terminal strip positions in the SCC-C sample gas cooler

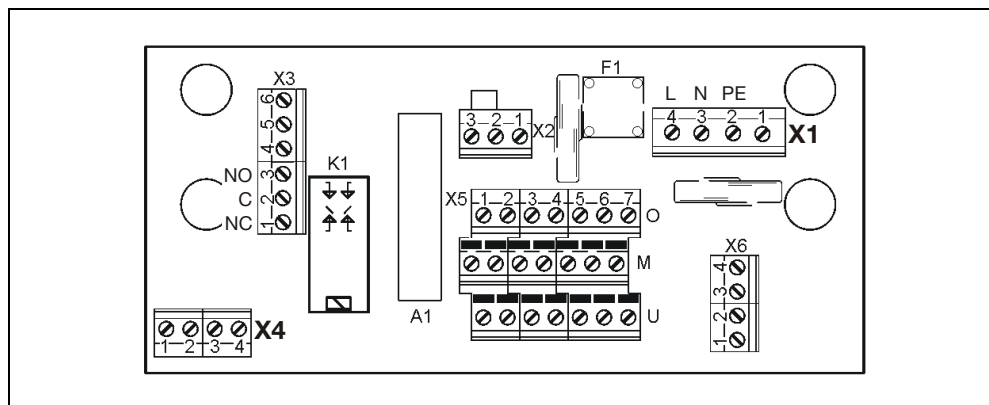





- X1** Power supply
- X2** Internal power supply voltage switching
- X3** Status signal (temperature alarm)
- X4** Pt 100 resistance thermometer (option)
- X5** Power supply of the internal modules
- X6** Temperature controller

Connecting the electrical leads: SCC-F with I/O card

Connecting the electrical leads

(see Figures 5, 6 and 7)



Step	Action
Connect signal and control leads to the sample gas feed unit:	
1	<p>Connect the status signal leads of the external devices (e.g. condensate collecting bottle, reagent supply bottle) to terminal strips X10 (digital inputs DI1 – DI6) and X6 (digital inputs DI7 – DI8). Tightening torque of the screws 0.22–0.25 Nm.</p> <p> Before connecting the leads remove the factory-installed wire jumpers from the respective terminals. Do not remove the wire jumpers from the unused terminals.</p>
2	<p>Connect the alarm signal leads to terminal strip X16 (digital outputs DO1 and DO2). Tightening torque of the screws 0.22–0.25 Nm.</p>
3	<p>Connect the leads of the external solenoid valves (e.g. for zero gas injection)</p> <ul style="list-style-type: none"> • to terminals 8 and 9 on terminal strip X7 (gas feed path 1) and/or • to terminals 5 and 6 on terminal strip X4 (gas feed path 2) and/or • to terminals 7 and 8 on terminal strip X4 (gas feed path 3). <p>Tightening torque of the screws 0.5–0.6 Nm.</p> <p> Observe the polarity of the connections!</p>
If necessary connect the sample gas cooler to the sample gas feed unit:	
4	<p>Side-by-side installation: Pull both connection cables for the Pt 100 resistance thermometer and power supply of the sample gas cooler (delivered with the unit, see section “Scope of delivery”, page 8) through the rubber bushing.</p> <p> If the sample gas cooler is provided with a signal cable for the temperature alarm this cable should be disconnected from terminal strip X3 since it is not intended to be connected to the I/O card.</p>
5	<p>Connect the 2-wire connection cable for the Pt 100 resistance thermometer</p> <ul style="list-style-type: none"> • to terminals 7 and 8 on terminal strip X16 in the sample gas feed unit and • to terminals 1 and 2 on terminal strip X4 in the sample gas cooler. <p>Tightening torque of the screws 0.22–0.25 Nm.</p> <p> The Pt 100 resistance thermometer is connected to terminals 3 and 4 on terminal strip X4 in the sample gas cooler.</p>
6	<p>Connect the 3-wire connection cable for the sample gas cooler’s power supply</p> <ul style="list-style-type: none"> • to terminals L, N and PE on terminal strip X3 in the sample gas feed unit and • to terminals 2, 3 and 4 on terminal strip X1 in the sample gas cooler. <p>Tightening torque of the screws 0.5–0.6 Nm.</p> <p> If the sample gas cooler is provided with a power supply cable this cable can be used to connect the sample gas feed unit to the power supply (see step 12).</p>
Connect the sample gas feed unit to the system bus:	
7	<ul style="list-style-type: none"> • Attach a T-piece to the system bus connector on the top of the sample gas feed unit casing. • Connect the system bus cable to the T-piece. • Connect a termination resistor to the free end of the T-piece.

Continued on next page

Connecting the electrical leads: SCC-F with I/O card, *continued*

Connecting the electrical leads

(continued)

Step	Action
Connect the power supply to the sample gas feed unit:	
8	 Make sure the voltage setting shown on the rating plate matches the line voltage.
9	Observe the requirements for the power supply cables! Sample gas feed unit: Outer diameter 4.5–10 mm, suitable for cable gland M16; wire cross-section 3 x min. 1.5 mm ² ; flammability class VW-1 and FT-1; temperature resistance ambient temperature > 60 °C. External solenoid valves: Outer diameter 3–7 mm, suitable for cable gland M12; wire cross-section 2 x min. 1.5 mm ² ; flammability class VW-1 and FT-1; temperature resistance ambient temperature > 60 °C.
10	Make sure the power supply leads have an adequately dimensioned protective device (breaker max. 20 A).
11	Install a switched outlet or a breaker in the power supply wiring near the sample gas feed unit. This should allow the sample gas feed unit to be completely disconnected from the power supply if necessary. The disconnection device should be identified in such a way that its relationship to the equipment that it is designed to disconnect can be clearly seen.
12	Connect the power supply leads to terminals L, N and PE on terminal strip X1 . Tightening torque of the screws 0.5–0.6 Nm.
13	Connect the power supply cable to the power supply.  The sample gas feed unit may start when the power supply is connected.

Continued on next page

Figure 6

**Connection diagram:
Sample gas feed unit
with I/O card**

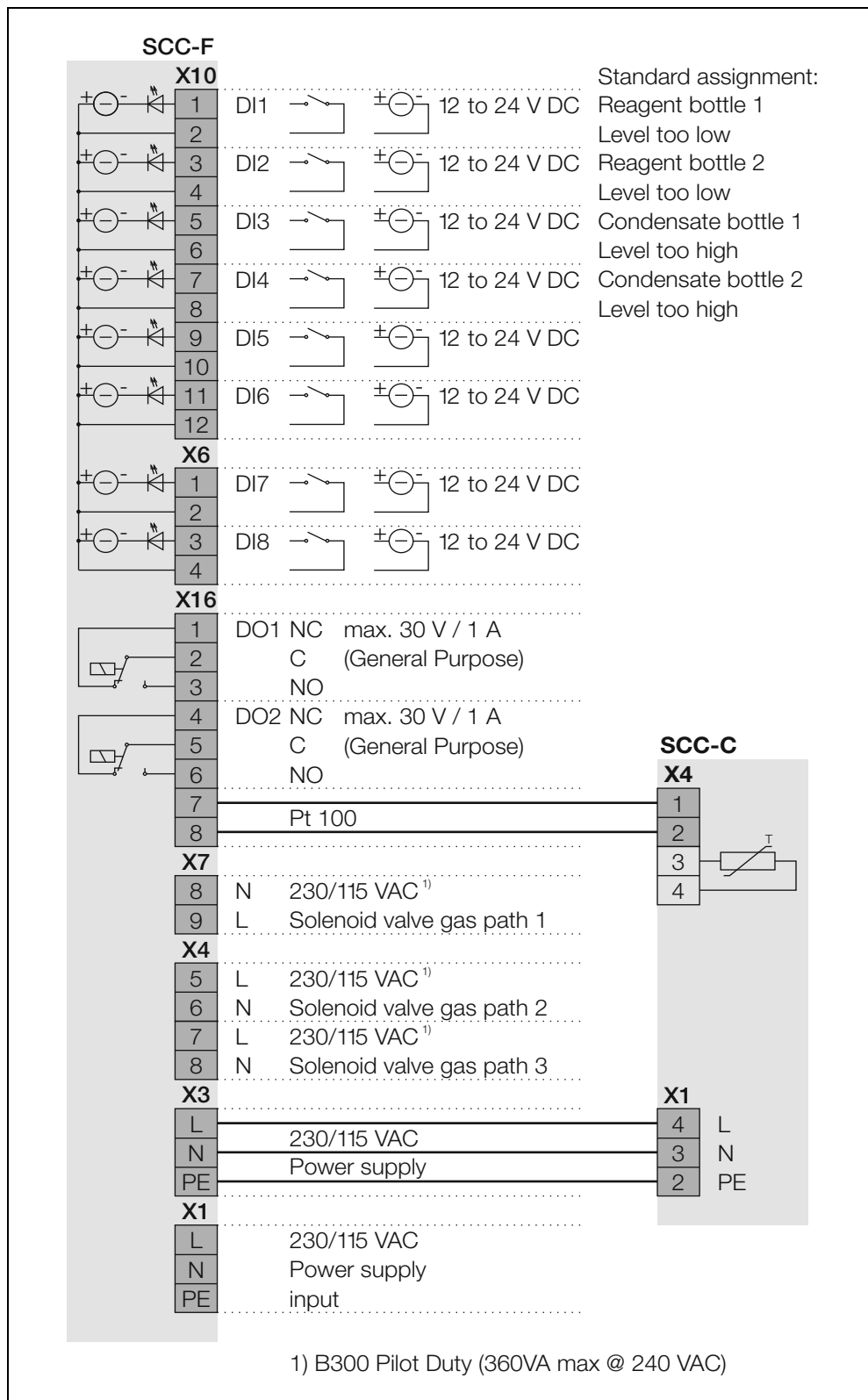

Continued on next page

Figure 7

Terminal strip positions on the I/O card in the sample gas feed unit

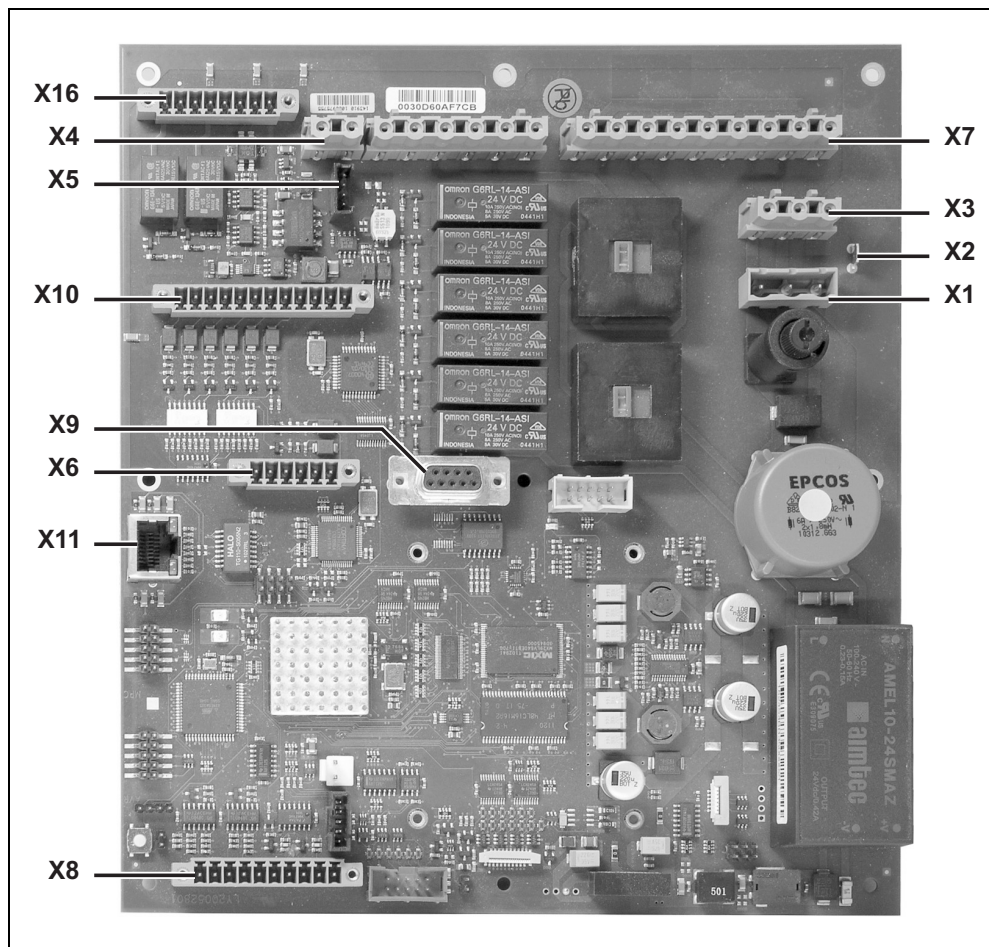

- X1** Power supply input
- X2** Ground
- X3** Power supply output (to SCC-C sample gas cooler)
- X4** Diaphragm pump and solenoid valve gas feed paths 2 and 3
- X5** System bus (internal connection to the connector on the top of the casing)
- X6** Digital inputs DI7 and DI8
- X7** Diaphragm pump and solenoid valve gas path 1, dosing pump
- X8** Condensate sensors 1 and 2, flow sensors 1 and 2 (internal connections)
- X9** Service interface (RS232)
- X10** Digital inputs DI1 to DI6 (status signals from external devices)
- X11** Service interface (Ethernet)
- X16** Digital outputs DO1 and DO2 (alarm signals), Pt 100 input (from SCC-C)



For information on the system bus structure and I/O card functions refer to section “I/O card” (see page 38).

Setting up the I/O card in the gas analyzer

Setting up the I/O card in the gas analyzer

The I/O card must be signed into the AO2000 gas analyzer. This takes place by entering the serial number of the card in the AO2000 menu item **Setup system modules**.

Menu path

MENU → Configure → System → Setup system modules

Serial number

The 14 digit serial number can be found on an adhesive label on the I/O card.

The serial number contains the following information (example):

0 0 6 0 1 6 0 0 0 1 2 3 0 1

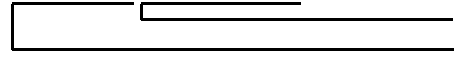
 Serial number of the I/O card
Module type 006016 = I/O card

Connecting the sample gas pipes

Sample gas connections

The sample gas connections are PVDF screw connections for DN 4/6 mm hose.

The sample gas inlets and outlets on the top of the sample gas feed unit are identified with arrows and numbers.

Connect sample gas pipes

Connect the sample gas pipes to the sample gas inlets and outlets. The sample gas pipes should be made from material that is suited to the measuring task.



Observe the sample gas inlet conditions (see page 8)!

Power supply activation, lead time



CAUTION!

Before activating the power supply check once again that the operating voltage setting (see rating plate) matches the line voltage.

The sample gas flow should only be started after the lead time period.

Power supply activation

Activate the power supply using the externally installed breaker or the switched outlet.

The diaphragm pumps and the dosing pump (and where applicable the hose pumps in the sample gas cooler) start running.

Lead time

The lead time for the sample gas feed unit is approx. 10 minutes. However, the lead time of the connected sample gas cooler is of greater importance. In the case of the SCC-C sample gas cooler the lead time is approx. 15 minutes.

Status signals

The flow alarms are present during the lead time. The condensate alarms may also be present.

Readiness

At the end of the lead time period the sample gas feed unit is ready for operation.

Switch on sample gas

The sample gas must not be switched on until the sample gas cooler's lead time has finished, i.e. until the sample gas outlet temperature lies within the limit values set in the factory.

Set sample gas flow

Set the sample gas flow using the appropriate needle valve.



CAUTION!

The needle valves must never be closed completely.



CAUTION!

The operations described in this chapter require specialized knowledge, and sometimes involve the necessity of working on the sample gas feed unit with its cover open and live. They must therefore only be carried out by qualified and specially trained persons.



WARNING EXPLOSION HAZARD!

Substitution of components may impair suitability for Class I, Division 2.

Do not disconnect equipment unless power has been switched off or the area is known to be non-hazardous.

I/O connectors must only be connected to Class 2 circuits.

Replacing the dosing pump hose

When does the hose need to be replaced?

Depending on the operating cycle, the dosing pump hose should be replaced at least every 5 months.



CAUTION!

Never lubricate the dosing pump hose.

The hose can contain acid residue. These materials can flow out when the hose connections are opened. Take appropriate measures where needed to collect residual acid. Appropriate precautions should be taken, and relevant regulations on disposal should be complied with.

Replace dosing pump hose

(see Figure 8)

Step	Action
1	 Stop the sample gas supply and shut off the sample gas feed unit power supply.
Remove the old hose:	
2	Loosen the hoses from the hose connections 4 .
3	Using the handles, press the moving belt 1 together and turn the S-clip 2 in a clockwise direction as far as its limit stop.
4	Remove the moving belt 1 from the pump head and pull the old hose 3 by the hose connections 4 to release it from the moving belt's guides.
5	Press the pressure rollers 5 together and check the spring pressure; if it is too weak, then the pressure springs and possibly rollers should be replaced (see page 26).

Continued on next page

Replacing the dosing pump hose, *continued*

Replace dosing pump hose

(*continued*)

Step	Action
Fit a new hose:	
6	Insert a new hose 3 with hose connections in the guides on the moving belt 1 .
7	Insert moving belt 1 with the new hose in the dovetail guide 6 in the pump head; using the handles, press the moving belt together while at the same time turning the S-clip 2 counterclockwise until it engages.
8	Screw the hoses to the hose connections 4 .  Take care not to kink or crush the hoses.
Start the sample gas feed unit again:	
9	Switch on power supply to feed unit.
10	The sample gas flow should only be restarted after the lead time period.

Figure 8

Dosing pump, hose and pump head with roller mounting

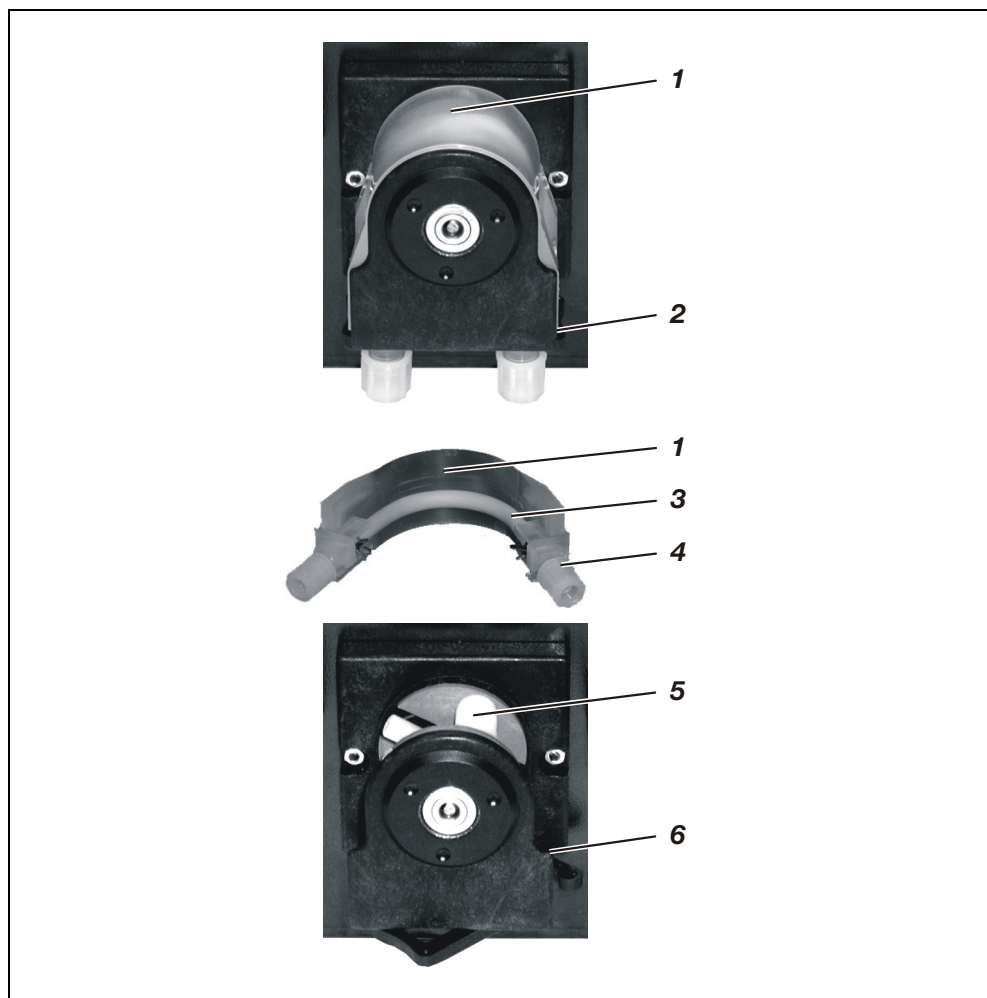

1 Moving belt
2 S-clip

3 Hose
4 Hose connections

5 Pressure rollers
6 Dovetail guides

Replacing the dosing pump pressure rollers and springs



When do the pressure rollers and springs need to be replaced?

The pressure rollers in the dosing pump must be replaced when their surface is damaged.

The pressure springs in the dosing pump must be replaced when they are broken.

Replace pressure rollers and springs

(see Figure 9)

Step	Action
1	 Stop the sample gas supply and shut off the sample gas feed unit power supply.
Remove the hose:	
2	Using the handles, press the moving belt 1 together and turn the S-clip 2 in a clockwise direction as far as its limit stop; then remove the moving belt and hose from the pump head.
Dismantle the pump head:	
3	Unscrew the two nuts 3 that secure the pump head (spanner size 5.5).
4	Pull the pump head 4 off the roller bearing axle, and remove the roller mounting 5 from the pump head.
Replace pressure rollers and springs:	
5	Pull the pressure springs 6 out of the hole in the roller mounting 5 and out of the retaining slot in the roller axle 7 . Remove the roller axle from the roller mounting, and pull the pressure roller 8 off the roller axle.
6	Push the new pressure roller 8 onto the roller axle 7 and secure with new pressure springs 6 in the roller mounting 5 .
Fit the pump head:	
7	Insert the roller mounting 5 in the pump head 4 , and push both components together onto the roller mounting axle. During this process, check to ensure that the roller mounting axle and roller mounting fit together properly.
8	Secure the pump head 4 with the two nuts 3 .
	 It is expedient to open the front panel forwards: this enables the pump's base plate with the fastening screws to be secured from inside.
Refit the hose:	
9	Insert moving belt 1 with the hose in the pump head; using the handles, press the moving belt together while at the same time turning the S-clip 2 counterclockwise until it engages.
Start the sample gas feed unit again:	
10	Switch on power supply to sample gas feed unit.
11	The sample gas flow should only be restarted after the lead time period.

Continued on next page

Figure 9

**Dosing pump,
roller mounting**

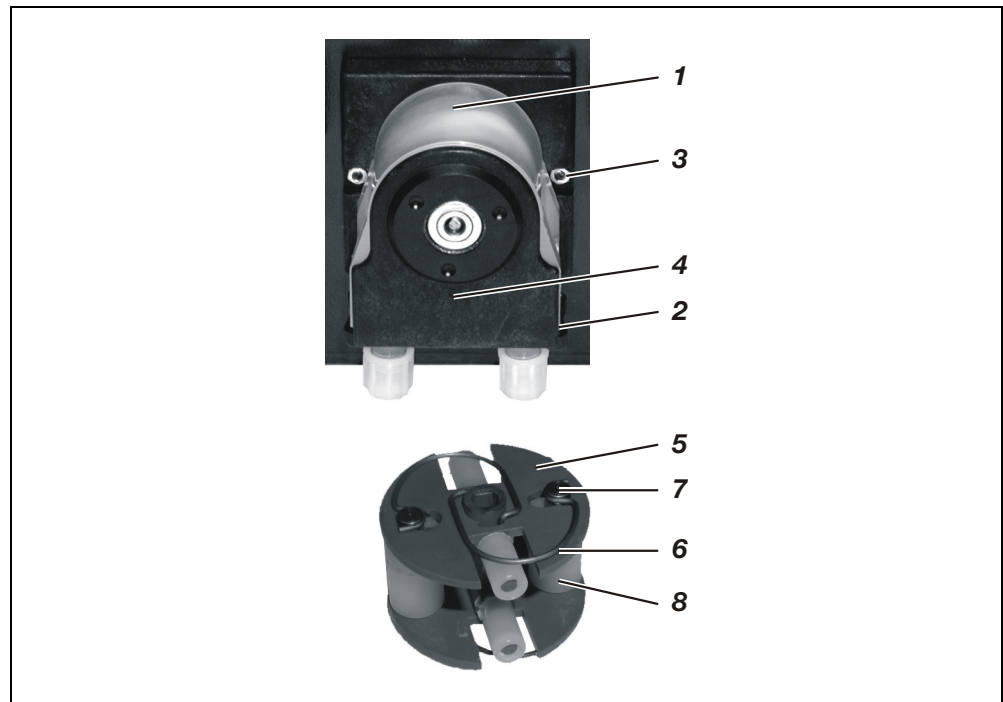

1 Moving belt

2 S-clip

3 Nuts for securing the pump head (x 2)

4 Pump head

5 Roller mounting

6 Pressure springs (x 4)

7 Roller axle

8 Pressure roller (x 2)

Replacing the diaphragm and valve plates in the diaphragm pump

When do the diaphragm and valve plates need to be replaced?

The diaphragm and valve plates in the diaphragm pump must be replaced when the diaphragm pump no longer feeds gas efficiently enough.



CAUTION!

Residues from the gas that the pump has been feeding may be found on the diaphragm and valve plates. These materials can flow out when the diaphragm pump is opened. Take appropriate measures where needed to collect such residues.

The medium being fed may be corrosive and poisonous. Appropriate precautions must be taken.

Figure 10
Diaphragm pump

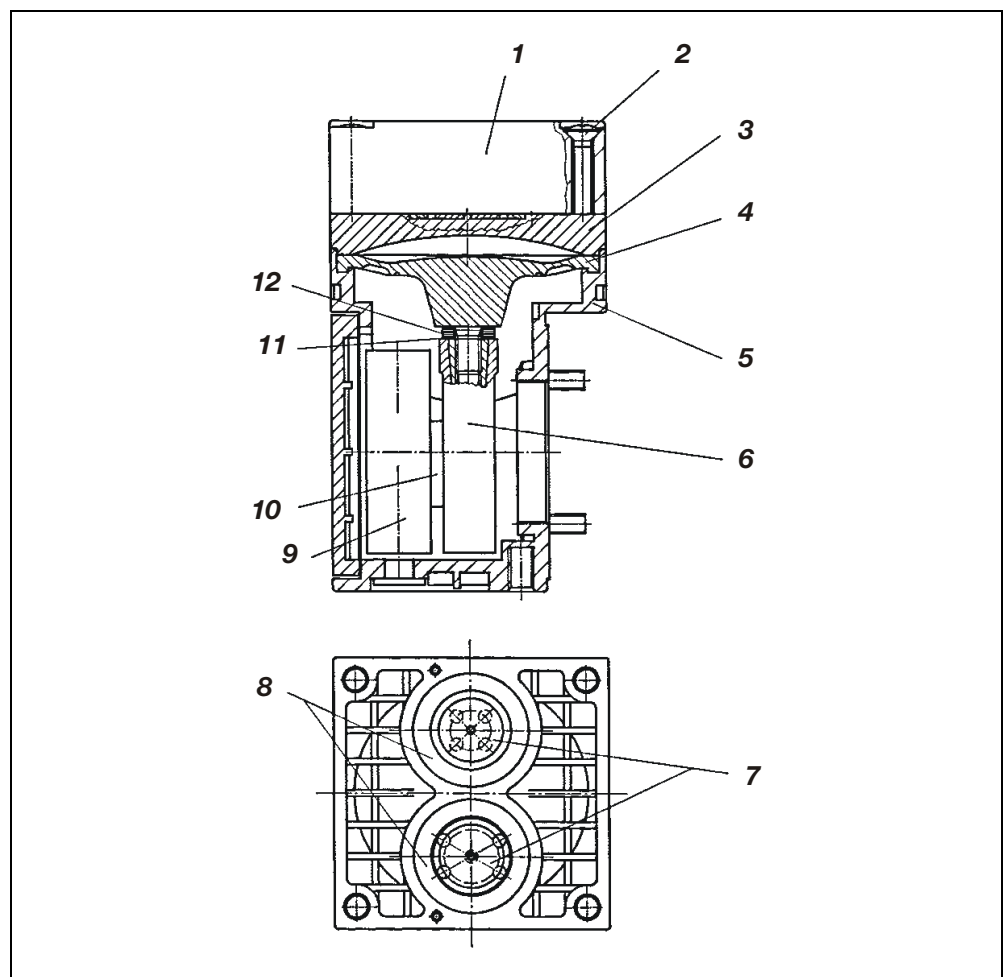





- | | | |
|-------------------------------|-------------------------|-----------------------------|
| 1 Head cap | 5 Casing | 9 Counter weight |
| 2 Head cap screws | 6 Connecting rod | 10 Eccentric |
| 3 Spacer plate | 7 Valve plates | 11 Belleville spring |
| 4 Structural diaphragm | 8 Sealing rings | 12 Distance ring(s) |

Continued on next page

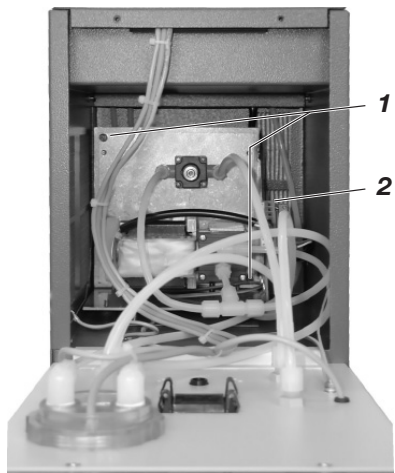
Replacing the diaphragm and valve plates, *continued*

Replace diaphragm and valve plates in the diaphragm pump

Step	Action
1	 Stop the sample gas supply and shut off the sample gas feed unit power supply.
Dismantle the diaphragm pumps:	
2	Disconnect electrical connection 2 , loosen two hex socket head screws 1 and remove mounting plate with the pumps from the sample gas feed unit's casing.
	
3	Take off the pump hoses and clean the outside of the pump.
Remove the pump head:	
4	Mark the head cap 1 , spacer plate 3 and casing 5 with a felt pen. This prevents the possibility of these parts being fitted incorrectly when the pump is reassembled later.
5	Undo the four head cover screws 2 and remove the head cap along with the spacer plate from the pump casing.
Replace diaphragm:	
6	Move the structural diaphragm 4 by rotating the fan impeller to its upper return point.
7	Hold opposite sides of the structural diaphragm, raise it, and then remove it by rotating in a counterclockwise direction.  During this procedure you should take care to ensure that the Belleville spring 11 and the distance ring(s) 12 do not fall from the structural membrane's threaded bolt into the casing.
8	Remove the Belleville spring 11 and distance ring(s) 12 from the structural diaphragm's threaded bolt and retain them.
9	Check all the parts for dirt and, if necessary, clean them with a dry cloth or compressed air.  Do not use solvents for cleaning as they can attack the plastic parts.
10	Push the distance ring(s) and the Belleville spring in that order onto the threaded bolt of the new structural diaphragm.  The disk edge of the spring must be aligned with the structural diaphragm.
11	Move the connecting rod 6 to its upper return point.
12	Screw the new structural diaphragm with distance ring(s) and Belleville spring in a clockwise direction onto the connecting rod and hand-tighten it.

Continued on next page

Replacing the diaphragm and valve plates, *continued*

Replace diaphragm and valve plates in the diaphragm pump

(continued)

Step	Action
Replace valve plates:	
13	Separate head cap 1 from the spacer plate 3 .
14	Remove the valve plates 7 and the sealing rings 8 from the spacer plate 3 .
15	Check that the valve seats, spacer plate and head cap are clean; if any of them display unevenness, scratches or corrosion they should be replaced.
16	Insert the new valve plates in the valve seats on the spacer plate. The valve plates for the compression and suction sides are identical; the same applies to the upper and lower sides of the valve plates.
17	Move the valve plates gently in a horizontal plane to ensure that they are not locked.
18	Insert sealing rings in the spacer plate.
Fit the pump head:	
19	Using the fan impeller, move the structural diaphragm to its upper dead point.
20	Place the spacer plate 3 , the valve plates 7 , sealing rings 8 and the head cap 1 on the casing in accordance with the markings.
21	Check that the head cap is centered correctly by moving it gently sideways.
22	Tighten the head cap screws 2 crosswise only slightly.
23	Check that the pump moves freely by turning the fan impeller.
24	Using the fan impeller, move the structural diaphragm to its upper dead point.
25	Hand-tighten the head cap screws.
Reinstall diaphragm pumps:	
26	Connect pump hoses.
27	Insert mounting plate with the pumps into the sample gas feed unit's casing and fasten it with the two hex socket head screws 1 . Connect electrical connection 2 .
Start the sample gas feed unit again:	
28	Check that the gas paths have no leaks (see instructions on page 31).
29	Switch on power supply to feed unit.
30	The sample gas flow should only be restarted after the lead time period.

Checking the gas paths for leaks

When do the gas paths need to be checked for leaks?

The gas paths should be checked for leaks regularly.

They must be checked after the gas paths inside the sample gas feed unit have been opened.



The sample gas feed unit must be checked from both sample gas connections because of the valves in the built-in diaphragm pump.

Check for leaks

Step	Action
1	Block off the sample gas outlet.
2	Apply a positive pressure of 100 mbar to the sample gas inlet.
3	Using a U-pipe manometer, for example (pipe diameter 7 to 8 mm), check the drop in pressure; this must not exceed 0.1 mbar per minute.
4	Similarly, check for leaks from the other side.

Troubleshooting

Problem	Cause	Remedy
Feed unit not working	Power supply interrupted	Reconnect the power supply.
	Fuse blown	Replace fuse (5x20 mm T6.3H250V).
	Pump motor blocked	Remove blockage.
	Defective pump	Replace pump.
	Defective diaphragm	Replace diaphragm (see page 28).
Drops of condensate in the condensate monitor or flow monitor (liquid alarm)	Condensate being produced by the gas analysis system	1. Check operability of the upstream condensate separation device, and rectify cause.
	Fluid from the process penetrating	2. Empty, clean and dry the upstream sample gas pipe and sample gas conditioning units.
	Sample gas cooler's condensate collecting vessel full	3. Empty, clean and dry the condensate monitor.
		4. Replace filter diaphragm.
		5. Press reset switch on the front panel to deactivate the condensate lock.
Sample gas flow insufficient (flow alarm)	Upstream sample gas pipe or modules blocked or sealed off	Remove blockage or open modules.
	Downstream modules blocked or sealed off	Remove blockage or open modules.
	Negative pressure on the gas sampling side	Rectify negative pressure.
	Positive pressure in the waste gas pipe	Rectify positive pressure.

Shutting down the sample gas feed unit



CAUTION!

Before the sample gas feed unit is shut down it must be purged to prevent the accumulation of condensate and deposits.

Shut down the sample gas feed unit

Step	Action
1	Disconnect the power supply.
2	Shut off the sample gas supply to the sample gas feed unit.
3	Remove the gas pipes from the connections on the sample gas feed unit.
4	Thoroughly purge the sample gas feed unit gas paths with an inert gas.
5	Fully tighten the gas connections.
6	Remove the electrical cables from the sample gas feed unit connections.



Make sure the sample gas feed unit is free of residual moisture that can freeze if low temperatures are encountered during shipping and storage.



Ambient temperature for storage and transportation: -25 to +60 °C

Packing the sample gas feed unit

Activate diaphragm pumps transportation restraints

Step	Action
1	Using a Ph2 crosshead screwdriver, screw two M6x25 screws through the holes in the base plate into the diaphragm pumps base plate and tighten them.

Packing the sample gas feed unit

Step	Action
1	<p>If the original packaging is not available, wrap the sample gas feed unit in bubble foil or corrugated cardboard.</p> <p>When shipping overseas additionally place the sample gas feed unit in a 0.2-mm thick polyethylene bag, add a drying agent (such as silica gel) and seal the bag air-tight.</p> <p> Use an amount of drying agent appropriate for the package volume and the planned shipping schedule (at least 3 months).</p>
2	<p>Place the sample gas feed unit in an adequately sized box lined with cushioning material (foam or similar substance).</p> <p> The cushioning material's thickness should be adequate for the sample gas feed unit's weight.</p> <p>When shipping overseas the box should also be lined with a layer of protective waterproof wrapping.</p>
3	Mark the box "Fragile item" and "Transport upright".

Ambient temperature Ambient temperature for storage and transportation: -25 to +60 °C

Use and functions of the sample gas feed unit

The purpose of using the sample gas feed unit

The SCC-F sample gas feed unit forms part of the sample gas conditioning system in an analysis system. It is designed for continuous dosed feeding of sample gas.

The sample gas feed unit is used to condition the sample gas, which has been extracted at a gas sampling point and which may have been pre-cleaned and dried, in terms of pressure and flow. The conditioning is carried out in such a way that a constant quantity of sample gas is supplied to the connected gas analyzer irrespective of the process conditions.

Functions of the sample gas feed unit

The functions of the SCC-F sample gas feed unit are:

- Feeding the sample gas,
- Fine-filtering the sample gas,
- Setting and monitoring the sample gas flow and
- Monitoring the sample gas feed path for condensate penetration, with fault status signaling and limit value signaling of the sample gas flow.

Use in conjunction with the SCC-C sample gas cooler

The SCC-F sample gas feed unit can be used in conjunction with the SCC-C sample gas cooler.

The functions of the SCC-C sample gas cooler are:

- Cooling the sample gas,
- Separating off the condensate and
- Removing the condensate.

Reagent dosing

The peristaltic hose pump for reagent dosing is installed as an option

- either in the sample gas feed unit (Catalog No. 23212-0-xx1xxx000000)
- or in the sample gas cooler (Catalog No. 23070-0-xxxx3xxx0000).

When the peristaltic pump is installed in the sample gas feed unit it is turned off when a "condensate" failure occurs. When the pump is installed in the sample gas cooler this is not possible.

The pump's feed performance is 15 ml/hour.

The functionality and operation of the sample gas cooler as well as the reagent dosing connection are described in the SCC-C sample gas cooler operator's manual (Document No. 42/23-55 EN).

Note on explosion protection

The SCC-F sample gas feed unit must not be used

- For feeding mixtures of gas/air or gas/oxygen that are capable of ignition during normal service,
- For feeding flammable gas, which can combine with air or oxygen to form an ignition-capable mixture, or
- In a potentially explosive atmosphere or in hazardous areas.

Description

Design

The SCC-F sample gas feed unit is produced in a 1/2 19-inch casing.

It contains:

- One or two diaphragm pumps for feeding the sample gas,
- One or two flow monitors with needle valves,
- One or two condensate monitors,
- One peristaltic pump for reagent dosing (optional) and
- A discharge controller (only in the version for bypass operation).

The switching amplifiers for operating and analyzing the flow and condensate monitors are integrated in the electronic processing unit.

Figure 11

**Circuit diagram
(Version without
I/O card)**

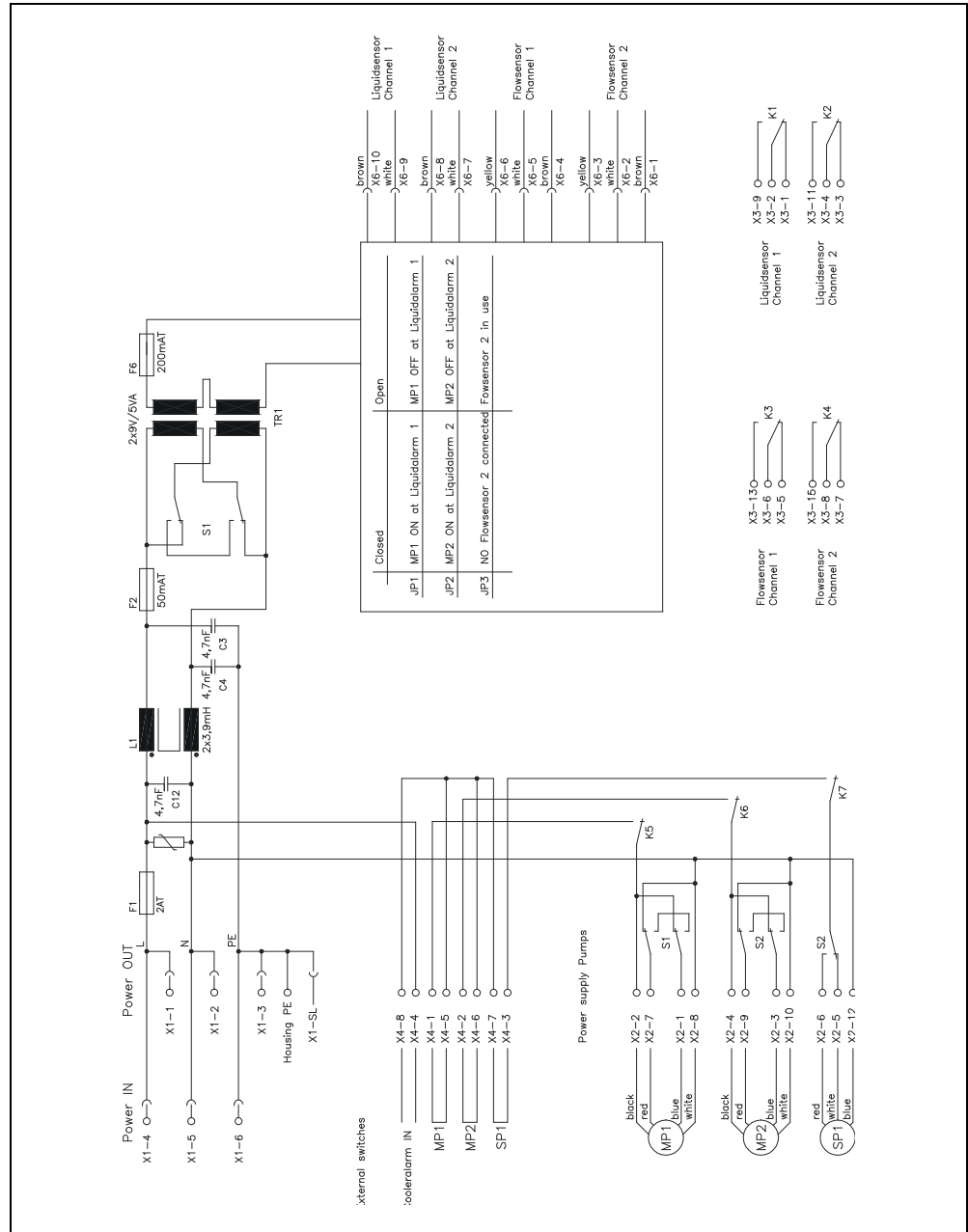

Pneumatic diagrams

Figure 12

Version Catalog No.
23212-0-11xxxx000000

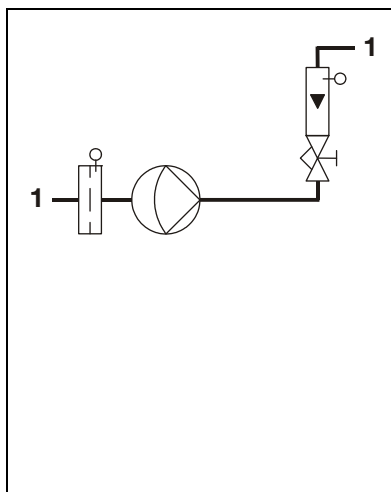

1 gas feed path with
1 condensate monitor, 1 flow monitor,
1 diaphragm pump

Figure 13

Version Catalog No.
23212-0-12xxxx000000

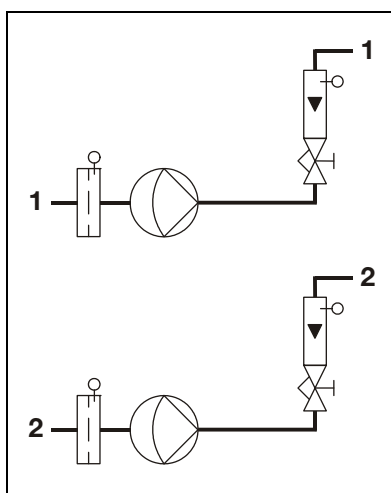

2 separate gas feed paths with
1 condensate monitor, 1 flow monitor and
1 diaphragm pump each

Figure 14

Version Catalog No.
23212-0-13xxxx000000

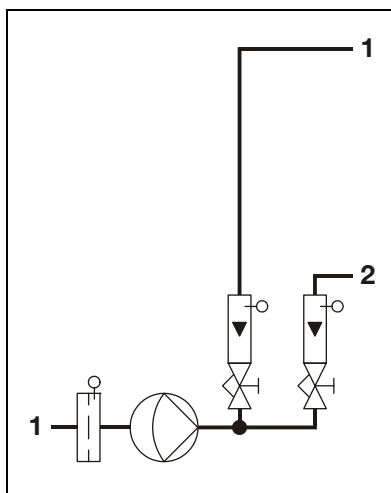

1 gas feed path with
1 condensate monitor, 1 diaphragm pump
2 flow monitors
(e.g. for NOx measurement)

Continued on next page

Figure 15

Version Catalog No.
23212-0-14xxxx000000

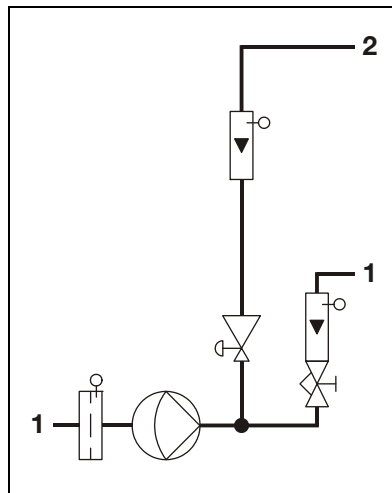

1 gas feed path with
1 condensate monitor, 1 diaphragm pump
2 flow monitors, 1 discharge controller (bypass)
(e.g. for achieving short dead times)

Figure 16

Version Catalog No.
23212-0-15xxxx000000

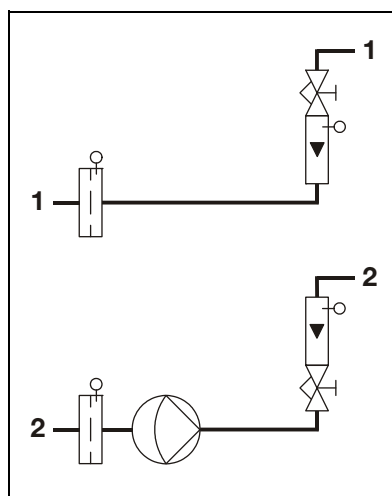

2 separate gas feed paths with
1 condensate monitor and 1 flow monitor each
and 1 diaphragm pump in first gas feed path
(with external pump in second gas feed path)

Figure 17

Version Catalog No.
23212-0-16xxxx000000

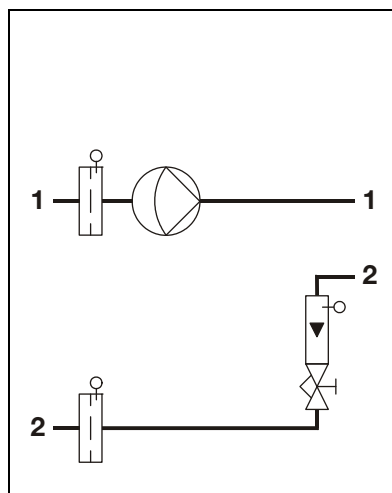

2 separate gas feed paths with
1 condensate monitor each, 1 flow monitor in
first gas feed path and 1 diaphragm pump in
second gas feed path
(e.g. for SO₂ measurement in separate gas
feed path with AO2000-Limas11)

I/O card option

An I/O card is installed in the SCC-F sample gas feed unit as an option. The SCC-F sample gas feed unit and the SCC-C sample gas cooler are connected to the AO2000 gas analyzers via the I/O card and the system bus (see Figure 18).

Figure 18

System bus structure (example)

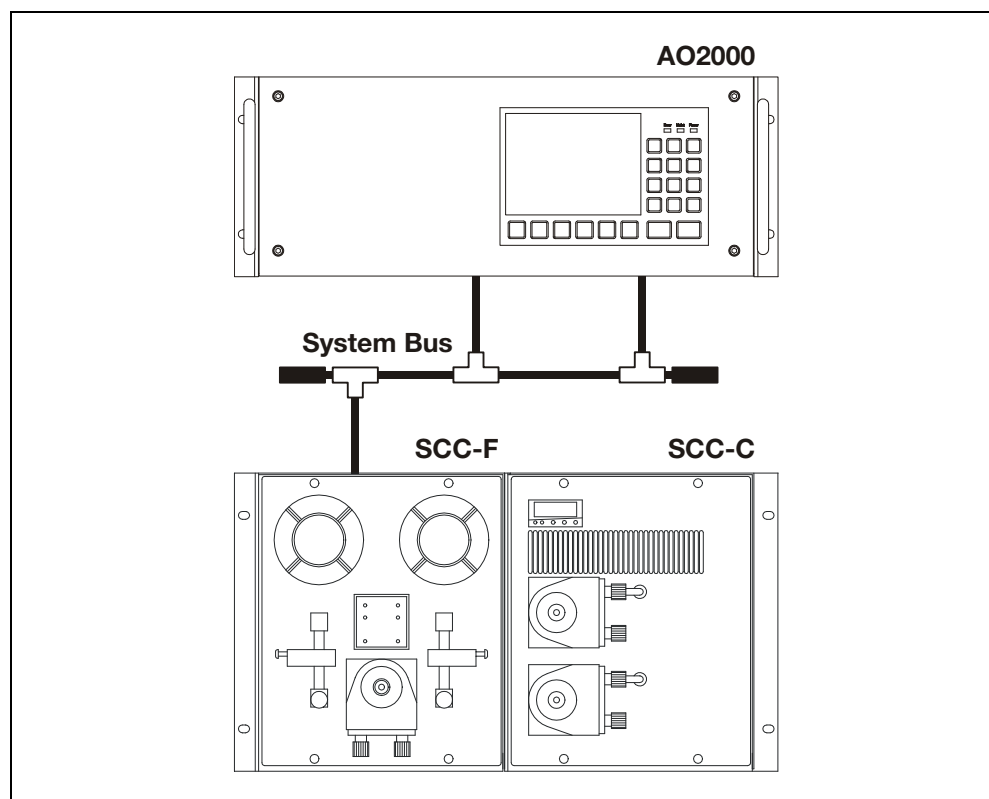

I/O card functions

Display of the cooler temperature	“Cooler” indication on the AO2000 screen
Monitoring of the cooler temperature	Status message “Failure” and shut-down of the sample gas pumps and the dosing pump if the cooler temperature is too high
Monitoring for break out of condensation	Status message “Failure” and shut-down of the sample gas pumps and the dosing pump at break out of condensation
Monitoring of the sample gas flow rate	Status message “Maintenance request” if the sample gas flow rate is too low
Monitoring of the level of the condensate collection bottle	Status message “Maintenance request” if the level is too high
Monitoring of the level of the reagent supply bottle	Status message “Maintenance request” if the level is too low
Control of external solenoid valves	for zero gas injection

Operating specifications

Operating specifications

Standard feed capacity

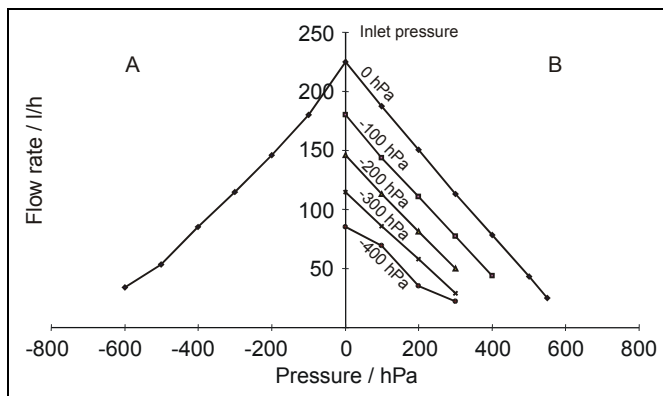

Bypass feed capacity

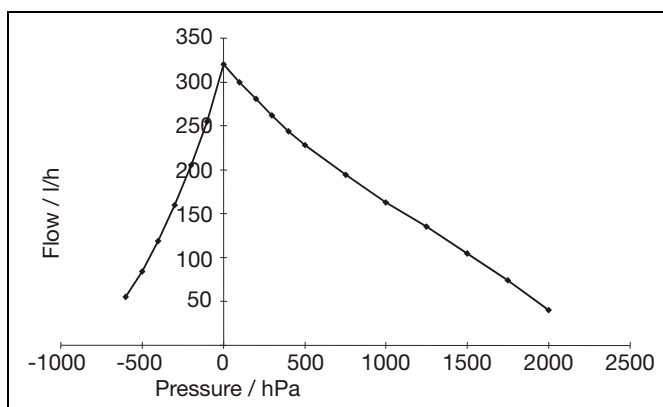

Lead time

Approx. 10 min. (plus cooler lead time)

Dead volume

Approx. 10 cm³ (plus dead volume of heat exchanger)

Gas seal integrity

5 x 10⁻⁶ hPa l/s

Index

	Page		Page
Ambient temperature	7	Connection diagram	20
Check for leaks	31	Description	38
Circuit diagram	35	Serial number	22
Connecting the electrical leads		Setting up in the gas analyzer	22
SCC-F with I/O card	18	Terminal strip positions	21
SCC-F without I/O card	15	Installation	10, 11
Connection diagram		Installation site	7
SCC-F with I/O card	20	Intended application	4
SCC-F without I/O card	16	Operating specifications	39
Description	35	Pneumatic diagrams	36
Diaphragm pump		Power supply	8
Replacing the diaphragm and valve plates	28	Activation	23
Dimensional drawing		Reagent dosing	34
Sample gas feed unit	9	Safety information	5, 6
Sample gas feed unit and sample gas cooler	11	Sample gas inlet conditions	8
Dosing pump		Scope of delivery	8
Replace hose	24	Standard model	4
Replace pressure rollers and springs	26	Status signals	23
Gas connections	22	Transportation restraints	10, 13, 33
Gas pipe connection	22	Troubleshooting	31
I/O card		Version for Class I, Div. 2	4
Connecting the electrical leads	18		

ABB has Sales & Customer Support expertise
in over 100 countries worldwide.

www.abb.com



ABB Automation GmbH
Analytical
Stierstaedter Strasse 5
60488 Frankfurt am Main
Germany
Fax: +49 69 7930-4566
E-Mail: cga@de.abb.com

3KXG171202R4201

The Company's policy is one of continuous product
improvement and the right is reserved to modify
the information contained herein without notice.

Printed in the Fed. Rep. of Germany (04.15)

© ABB 2015