

E96-436

Bailey®  
**infi 90**

# Instruction

## Analog Input Termination Module (NIA104)

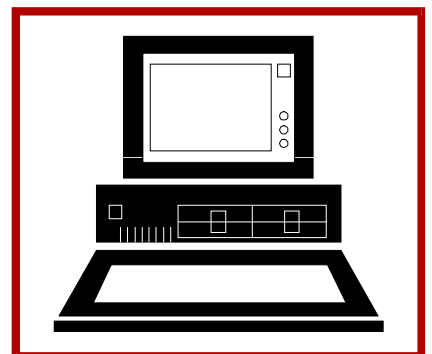
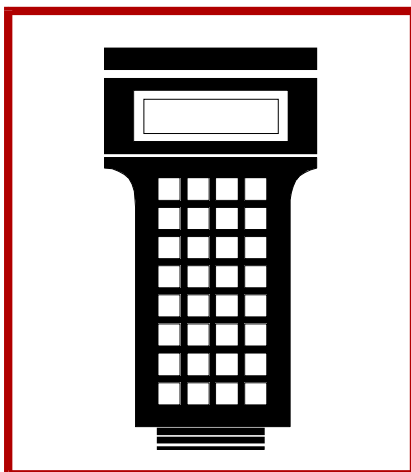
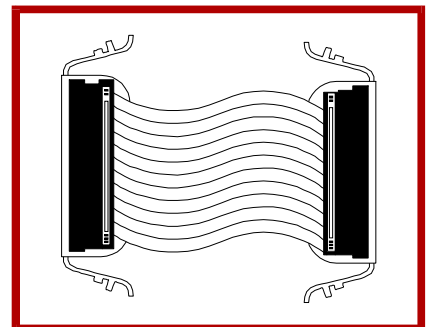
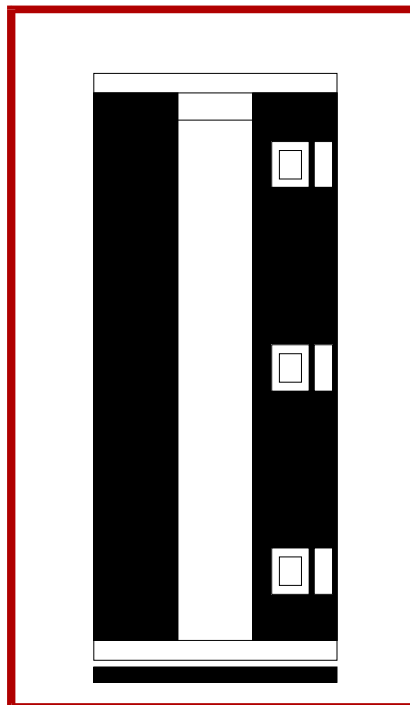
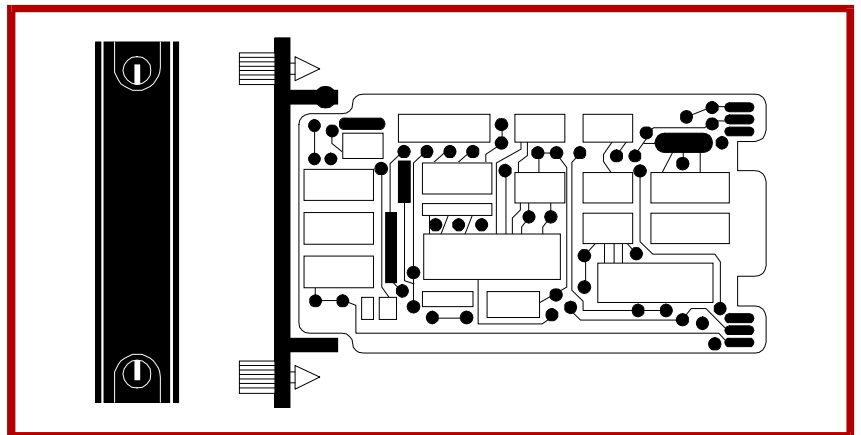
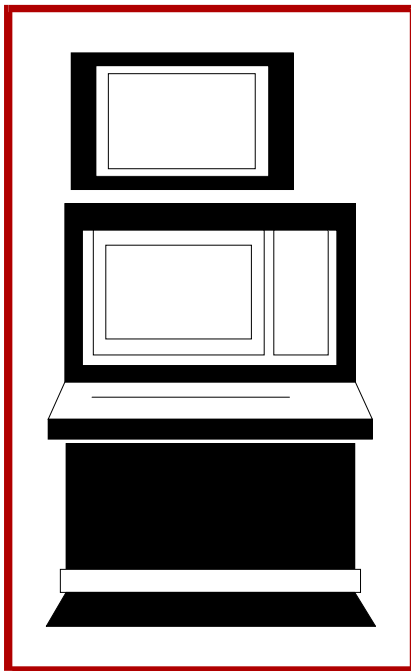

**WARNING** notices as used in this instruction apply to hazards or unsafe practices that could result in personal injury or death.

**CAUTION** notices apply to hazards or unsafe practices that could result in property damage.

**NOTES** highlight procedures and contain information that assists the operator in understanding the information contained in this instruction.

## WARNING

### INSTRUCTION MANUALS

DO NOT INSTALL, MAINTAIN, OR OPERATE THIS EQUIPMENT WITHOUT READING, UNDERSTANDING, AND FOLLOWING THE PROPER **Elsag Bailey** INSTRUCTIONS AND MANUALS; OTHERWISE, INJURY OR DAMAGE MAY RESULT.

### RADIO FREQUENCY INTERFERENCE

MOST ELECTRONIC EQUIPMENT IS INFLUENCED BY RADIO FREQUENCY INTERFERENCE (RFI). CAUTION SHOULD BE EXERCISED WITH REGARD TO THE USE OF PORTABLE COMMUNICATIONS EQUIPMENT IN THE AREA AROUND SUCH EQUIPMENT. PRUDENT PRACTICE DICTATES THAT SIGNS SHOULD BE POSTED IN THE VICINITY OF THE EQUIPMENT CAUTIONING AGAINST THE USE OF PORTABLE COMMUNICATIONS EQUIPMENT.

### POSSIBLE PROCESS UPSETS

MAINTENANCE MUST BE PERFORMED ONLY BY QUALIFIED PERSONNEL AND ONLY AFTER SECURING EQUIPMENT CONTROLLED BY THIS PRODUCT. ADJUSTING OR REMOVING THIS PRODUCT WHILE IT IS IN THE SYSTEM MAY UPSET THE PROCESS BEING CONTROLLED. SOME PROCESS UPSETS MAY CAUSE INJURY OR DAMAGE.

## AVERTISSEMENT

### MANUELS D'OPÉRATION

NE PAS METTRE EN PLACE, RÉPARER OU FAIRE FONCTIONNER L'ÉQUIPEMENT SANS AVOIR LU, COMPRIS ET SUIVI LES INSTRUCTIONS RÉGLEMENTAIRES DE **Elsag Bailey**. TOUTE NÉGLIGENCE À CET ÉGARD POURRAIT ÊTRE UNE CAUSE D'ACCIDENT OU DE DÉFAILLANCE DU MATÉRIEL.

### PERTURBATIONS PAR FRÉQUENCE RADIO

LA PLUPART DES ÉQUIPEMENTS ÉLECTRONIQUES SONT SENSIBLES AUX PERTURBATIONS PAR FRÉQUENCE RADIO. DES PRÉCAUTIONS DEVRONT ÊTRE PRISES LORS DE L'UTILISATION DU MATÉRIEL DE COMMUNICATION PORTATIF. LA PRUDENCE EXIGE QUE LES PRÉCAUTIONS À PRENDRE DANS CE CAS SOIENT SIGNALÉES AUX ENDROITS VOULUS DANS VOTRE USINE.

### PERTURBATIONS DU PROCÉDÉ

L'ENTRETIEN DOIT ÊTRE ASSURÉ PAR UNE PERSONNE QUALIFIÉE EN CONSIDÉRANT L'ASPECT SÉCURITAIRE DES ÉQUIPEMENTS CONTRÔLÉS PAR CE PRODUIT. L'AJUSTEMENT ET/OU L'EXTRACTION DE CE PRODUIT PEUT OCCASIONNER DES À-COUPS AU PROCÉDÉ CONTRÔLE LORSQU'IL EST INSÉRÉ DANS UNE SYSTÈME ACTIF. CES À-COUPS PEUVENT ÉGALEMENT OCCASIONNER DES BLESSURES OU DES DOMMAGES MATÉRIELS.

## NOTICE

The information contained in this document is subject to change without notice.

Elsag Bailey, its affiliates, employees, and agents, and the authors and contributors to this publication specifically disclaim all liabilities and warranties, express and implied (including warranties of merchantability and fitness for a particular purpose), for the accuracy, currency, completeness, and/or reliability of the information contained herein and/or for the fitness for any particular use and/or for the performance of any material and/or equipment selected in whole or part with the user of/or in reliance upon information contained herein. Selection of materials and/or equipment is at the sole risk of the user of this publication.

This document contains proprietary information of Elsag Bailey, Elsag Bailey Process Automation, and is issued in strict confidence. Its use, or reproduction for use, for the reverse engineering, development or manufacture of hardware or software described herein is prohibited. No part of this document may be photocopied or reproduced without the prior written consent of Elsag Bailey.

---

## Preface

---

Termination Modules provide an input connection from the plant equipment to the INFI 90 process modules. The Analog Input Termination Module (NIAI04) interfaces the Analog Slave Module (IMASM01) or the Analog Slave Modules (IMASIO2) and two-wire transmitters.

This manual explains how to install and use the NIAI04 on the INFI 90 system. It has sections that describe the setup and cabling. The appendices contain information about modules that use the NIAI04.

## List of Effective Pages

---

Total number of pages in this instruction is 19, consisting of the following:

<b>Page No.</b>	<b>Change Date</b>
Preface	Original
List of Effective Pages	Original
iii through v	Original
1-1 through 1-5	Original
2-1 through 2-5	Original
A-1 through A-2	Original
B-1 through B-2	Original

When an update is received, insert the latest changed pages and dispose of the superseded pages.

**NOTE:** On an update page, the changed text or table is indicated by a vertical bar in the outer margin of the page adjacent to the changed area. A changed figure is indicated by a vertical bar in the outer margin next to the figure caption. The date the update was prepared will appear beside the page number.

---

## Safety Summary

---

### GENERAL WARNINGS

#### Equipment Environment

All components, whether in transportation, operation or storage, must be in a noncorrosive environment.

#### Electrical Shock Hazard During Maintenance

Disconnect power or take precautions to insure that contact with energized parts is avoided when servicing.

### SPECIFIC CAUTIONS

We strongly recommend that you turn off cabinet power before doing any termination module wiring. Failure to do so could result in equipment damage. Do not apply power until you verify all wire connections. (p. 2-3)

---

## Sommaire de Sécurité

---

### AVERTISSEMENTS D'ORDRE GÉNÉRAL

#### Environnement de l'équipement

Ne pas soumettre les composants à une atmosphère corrosive lors du transport, de l'entreposage ou l'utilisation.

#### Possibilité de chocs électriques durant l'entretien

Débrancher l'alimentation ou prendre les précautions pour éviter tout contact avec des composants sous tension durant l'entretien.

### ATTENTIONS D'ORDRE SPÉCIFIQUE

Il est fortement recommande de debrancher l'alimentation électrique du cabinet avant d'effectuer tout connexion aux cartes de raccordement des modules. Des dommages aux équipements pourraient survenir dans le cas contraire. Ne pas rebrancher l'alimentation avant que toutes les connexions aient été vérifiées. (p. 2-3)

---

---

# Table of Contents

	<i>Page</i>
<b>SECTION 1 - INTRODUCTION</b> .....	<b>1-1</b>
OVERVIEW .....	1-1
INTENDED USER .....	1-1
MODULE DESCRIPTION .....	1-1
FEATURES .....	1-2
INSTRUCTION CONTENT .....	1-3
HOW TO USE THIS MANUAL .....	1-3
REFERENCE DOCUMENTS .....	1-3
GLOSSARY OF TERMS AND ABBREVIATIONS .....	1-4
NOMENCLATURE .....	1-4
SPECIFICATIONS .....	1-5
<b>SECTION 2 - INSTALLATION</b> .....	<b>2-1</b>
INTRODUCTION .....	2-1
UNPACKING AND INSPECTION .....	2-1
SETUP/INSTALLATION .....	2-1
Termination Module Configuration .....	2-1
Physical Installation .....	2-2
WIRING CONNECTIONS AND CABLING .....	2-3
Wiring .....	2-3
Cable Connections .....	2-5
FUSING .....	2-5
PRE-OPERATING ADJUSTMENTS .....	2-5
DIPSWITCH SETTINGS .....	2-5
<b>APPENDIX A - (IMASI02) ANALOG SLAVE INPUT MODULE</b> .....	<b>A-1</b>
INTRODUCTION .....	A-1
SETUP/INSTALLATION .....	A-1
CONFIGURING INPUTS .....	A-1
WIRING CONNECTIONS AND CABLING .....	A-1
<b>APPENDIX B - (IMASM01) ANALOG SLAVE MODULE</b> .....	<b>B-1</b>
INTRODUCTION .....	B-1
SETUP/INSTALLATION .....	B-1
CONFIGURING INPUTS .....	B-1
WIRING CONNECTIONS AND CABLING .....	B-1

---

## List of Figures

<i>No.</i>	<i>Title</i>	<i>Page</i>
1-1.	Application Example for NIAI04 .....	1-2
2-1.	NIAI04 Termination Module .....	2-2
2-2.	NIAI04 Input Circuit .....	2-3
2-3.	Terminal Assignments .....	2-4
2-4.	Input Termination Example .....	2-4
2-5.	Cable Connections.....	2-5
A-1.	Dipswitch Settings for IMASI02 .....	A-2
A-2.	Cable Connections.....	A-2
B-1.	Dipswitch Settings for IMASM01 .....	B-2
B-2.	Cable Connections.....	B-2

---

# SECTION 1 - INTRODUCTION

---

## OVERVIEW

The Analog Input Termination Module (NIAI04) inputs 15 channels of analog signals. It connects Analog Slave Module (IMASIO2) or Analog Slave Module (IMASMO1) to field equipment and Bailey smart transmitters. The signals pass through slave modules to the Multi-Function Processor (IMMFP01/02), Analog Master Module (IMAMMO3) or Network 90 Multi-Function Controllers and Analog Master Modules.

This manual explains the purpose, setup, handling precautions and steps to install the NIAI04 module.

---

## INTENDED USER

System engineers and technicians should read this manual before installing and using the Termination Module (TM). Put the module into operation only after reading and understanding this instruction. Refer to the **Table of Contents** to find the information you need. Refer to the **How To Use This Manual** entry in this section to help you get started.

---

## MODULE DESCRIPTION

The NIAI04 is a single printed circuit board that uses one slot in a Termination Mounting Unit (NTMU01/02). The TM has one card edge connector, P1. It carries the inputs to the slave module through a cable. The terminal blocks for field wiring are on the TM. See Figure 2-1.

The dipswitches on the NIAI04 module set the input type for the module. Refer to the appendix for the switch settings of the slave module you are using. Be sure to check the switch setting before putting the module into the TMU.

Figure 1-1 shows an application example for the NIAI04.

The NIAI04 handles up to 15 analog inputs for the ASI or 16 analog inputs for the ASM for the signal ranges listed. Each input may be differential or single ended.

- 4-20 mA DC, system or externally powered.
- -10 VDC to +10 VDC
- 0 VDC to 1 VDC
- 0 VDC to 5 VDC
- 0 VDC to 10 VDC
- 1 VDC to 5 VDC
- 0 VDC to 1 VDC (ASI only)



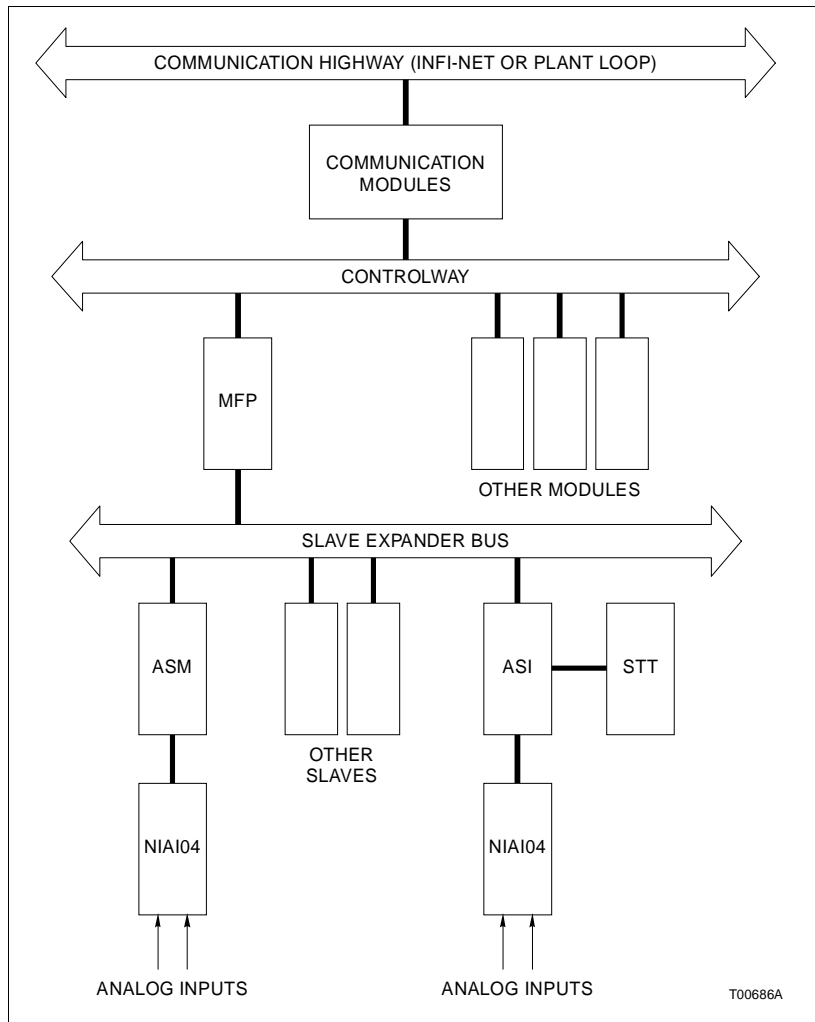

Figure 1-1. Application Example for NIAI04

## FEATURES

The design of the NIAI04, as with all INFI 90 devices, allows for flexibility in creating a process management system. Refer to the **NOMENCLATURE** entry of this section for the list of devices that can be used with the TM in an INFI 90 system.

- A standard factory-wired cable connects the TM to the slave module.
- On-board terminal blocks accept field and I/O wiring.
- Analog inputs routed between field devices and I/O modules.
- Connect I/O wires on terminals at the front edge of the TM.
- Each TM fits in a standard Termination Mounting Unit.
- Inputs may be either system or externally powered.

---

**INSTRUCTION CONTENT**

This manual has two sections.

**Introduction** Is an overview of the TM: features, description and specifications.

**Installation** Describes cautions to observe when handling the TM. It shows you the steps to follow to install and connect the module before you apply power. This section also presents switch and jumper settings.

**Appendices A and B** Contain data to connect the TM to the slave modules.

**Appendix A** shows the jumper settings, terminal wiring for the TM and the cabling needed for the Analog Slave Input Module (IMASIO2).

**Appendix B** shows the jumper settings, terminal wiring for the TM and the cabling needed for the Analog Slave Module (IMASM01).

---

**HOW TO USE THIS MANUAL**

Read this manual before handling the TM. Refer to the sections in this list as needed for more information.

1. Read **Section 2** before you connect the NIAI04.
2. Refer to **Appendix A** and **Appendix B** for the slave module you are connecting to the TM for more information.

---

**REFERENCE DOCUMENTS**

Document Number	Document
I-E96-318	Input Slave Module (IMASM01)
I-E96-304	Analog Input Slave Module (IMASIO2)
I-E96-201	Multi-Function Processor (IMMFP01)
I-E96-202	Multi-Function Processor (IMMFP02)
I-E92-501-2	Configuration and Tuning Terminal (CTT02)
I-E21-28	Smart Transmitter Terminal (STT02)

---

**GLOSSARY OF TERMS AND ABBREVIATIONS**

<b>Term</b>	<b>Definition</b>
Analog	A continuous time signal with an infinite number of values.
Dipshunt	Dual in-line package with shorting bars.
Dipswitch	A dual in-line package that contains single pole switches.
Smart Transmitter	A field measuring device that can handle digital communication. It allows configuring of operating parameters, on-line parameter changes and remote troubleshooting.
TM	Termination Module: Provides input/output connection between plant equipment and the INFI 90 process modules. The TM slides into a slot in the termination mounting unit.

---

**NOMENCLATURE**

The following modules and equipment can be used with the termination module:

<b>Nomenclature</b>	<b>Hardware</b>
IMASM01	Analog Input Slave Module
IMASI02	Analog Input Slave Module
IMMFP01	Multi-Function Processor
IMMFP02	Multi-Function Processor
STT02	Smart Transmitter Terminal
NKTM01	Cable, Termination Module
NKTU02	Cable, Termination Module
BC	Bailey Pressure Transmitters
EQ	Bailey Temperature Transmitters
pH	Bailey pH Transmitters

**SPECIFICATIONS**

<b>Wire Size</b>	
Minimum	22 gauge
Maximum	14 gauge
Maximum wire size when connecting three wires to a single terminal	one 16 gauge and two 18 gauge wires
<b>Mounting</b>	Slides into a single slot in the termination mounting unit NTMU01/02.
<b>Environmental</b>	
Electromagnetic/Radio Frequency Interference	No values available at this time. Keep cabinet doors closed. Do not use communication equipment closer than 2 meters from the cabinet.
Ambient Temperature	0 to 70° C (0 to 158° F)
Relative Humidity	5% to 95% up to 55° C (131° F) (non-condensing) 5% to 45% at 70° C (158° F) (non-condensing)
Atmospheric Pressure	Sea level to 3 km (1.86 miles)
Air Quality	Noncorrosive
<b>Cooling Requirements</b>	No cooling is necessary when used in Bailey cabinets and operated within stated limits.
<b>Certification</b>	CSA certified for use as process control equipment in an ordinary (nonhazardous) location.

SPECIFICATIONS SUBJECT TO CHANGE WITHOUT NOTICE

---

## SECTION 2 - INSTALLATION

---

### *INTRODUCTION*

This section explains what to do before you put the Analog Termination Module (NIAIO4) (TM) into operation. **DO NOT PROCEED** with operation until you read, understand and do the steps in the order that they appear.

---

### *UNPACKING AND INSPECTION*

These are steps to follow for general handling:

1. Examine the module to make sure that no damage has occurred in transit.
2. Notify the nearest Bailey Sales/Service Office of any damage.
3. File a claim for any damage with the shipping company that handled the shipment.
4. Use the original packing material or container to store the module.
5. Store the module in a place with clean air; free of extremes of temperature and humidity.

---

### *SETUP/INSTALLATION*

Before applying power to the TM, make these checks:

1. Check that the slave and master module address is set.
2. Be sure the dipshunts in the MMU's slave expander bus are installed.
3. Check that the dipswitches on the TM are set.
4. Verify I/O cabling connections.

---

### *Termination Module Configuration*

Set up the Termination Module (TM) to accept the analog field inputs sent to the slave module. Refer to [Appendix A](#) or [Appendix B](#) to find the setup for your application. Figure 2-1 shows the NIAIO4 Termination Unit.

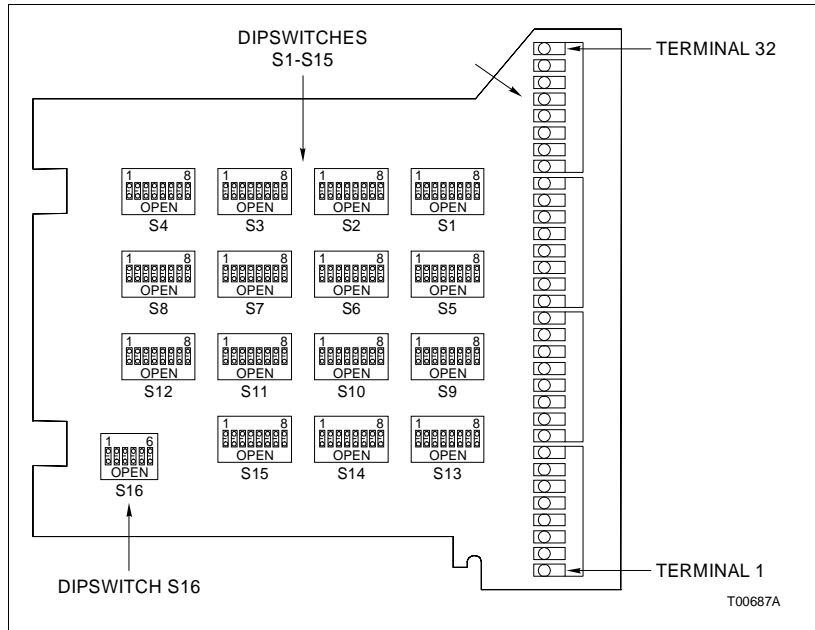

Figure 2-1. NIAI04 Termination Module

**Physical Installation**

**NOTE:** This section provides data to install the TM only. For more slave information, refer to the instruction manual for the slave module you are using.

The TM occupies one slot in a standard INFI 90 Termination Mounting Unit (NTMU01/02). To install:

1. Verify the slot placement of the module.
2. Connect the hooded end of the cable from the TM to the MMU backplane. To do this, insert the connector into the same backplane slot as assigned to the slave module. The latches should snap securely into place.
3. Plug the connector end into the P1 socket on the Termination Unit. The latches should snap securely into place.
4. Align the TM with the guide rails in the TMU. Carefully slide the module in until the front panel is flush with the top and bottom of the TMU frame.

**WIRING CONNECTIONS AND CABLING**

The NIAI04 has one card edge connector (P1) to supply power to the TM and provide analog inputs to the slave module

**Wiring**

<b>CAUTION</b>	<p><b>We strongly recommend that you turn off cabinet power before doing any termination module wiring. Failure to do so could result in equipment damage. Do not apply power until you verify all wire connections.</b></p>
<b>ATTENTION</b>	<p><b>Il est fortement recommande de debrancher l'alimentation électrique du cabinet avant d'effectuer tout connexion aux cartes de raccordment des modules. Des dommages aux equipments pourraient survenir dans le cas contraire. Ne pas rebrancher l'alimentation avant que toutes les connexions aient ete verifiees.</b></p>

Connect the wiring from the input devices sensing the process to the module terminals. Input devices may be: BC series Bailey Pressure Transmitters, EQ series Bailey Temperature Transmitters, pH series Bailey pH Transmitters or any conventional transmitter. See Figure 2-2 for an example of an NIAI04 input circuit and Figure 2-3 for the terminal assignments. Figure 2-4 shows an input termination example.

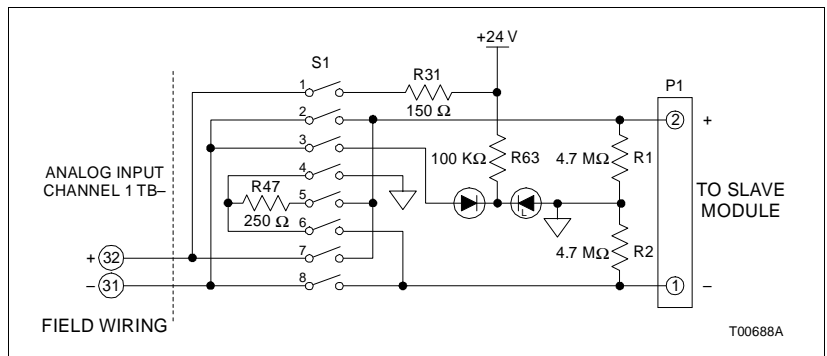

Figure 2-2. NIAI04 Input Circuit

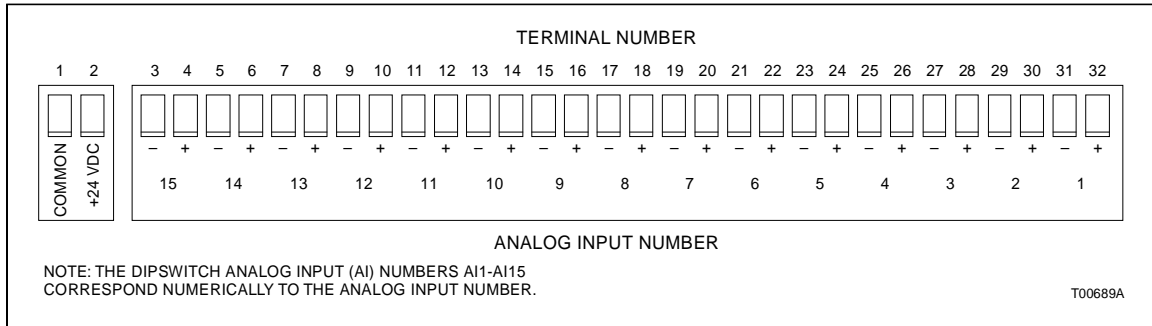

Figure 2-3. Terminal Assignments

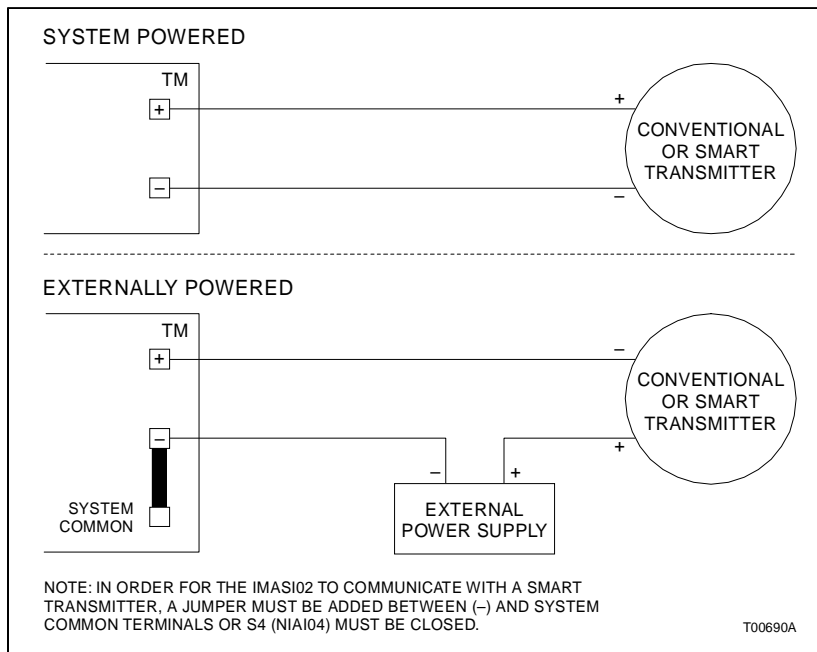

Figure 2-4. Input Termination Example



**Cable Connections**

Install the module connector cable (NKTU02 or NKTU01) to connect the TM to the slave. Either the NKTU02 cable can connect the TM to the slave module. The NKTU01 is a flat ribbon cable (100 foot maximum). Do not bundle the ribbon cable with AC wiring to reduce the chance of cross talk into the ribbon cable.

The NKTU02 is a round cable (200 foot maximum). The cable is not shielded; observe the same routing cautions as apply to the NKTU01. Figure 2-5 shows the connections for the TM cables.

**FUSING**

The NIAI04 does not have any on board fuses.

**PRE-OPERATING ADJUSTMENTS**

You do not have to adjust the NIAI04 before using.

**NOTE:** Check the dipswitches with the settings in the appendix before applying power.

**DIPSWITCH SETTINGS**

The dipswitches select the input type to match the device connected to the TU. Each channel is independent. Strap the dipshunt for voltage/current input, differential/single ended input, system/externally powered input. Set the dipswitches according to the instructions in the appendix for the slave and input type you are using.

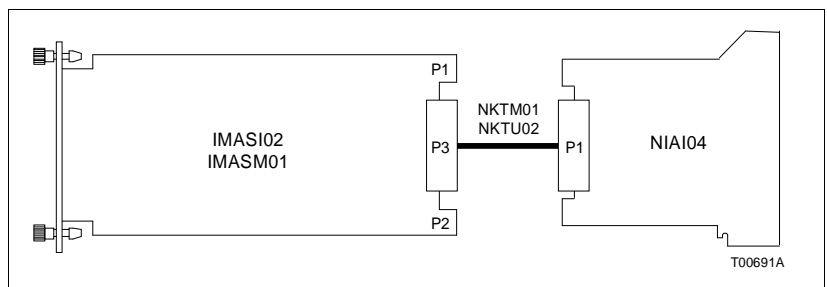

Figure 2-5. Cable Connections

---

# APPENDIX A - (IMASI02) ANALOG SLAVE INPUT MODULE

---

## INTRODUCTION

The Analog Slave Input Module (IMASI02) uses an NIAI04 for termination. Dipswitches on the NIAI04 Termination Module (TM) configure the 15 analog inputs for the ASI. The ASI accepts inputs of 4-20 milliamps, 1-5 VDC, 0-1 VDC, 0-5 VDC, 0-10 VDC, -10 VDC to +10 VDC and Bailey Smart Transmitters.

---

## SETUP/INSTALLATION

Before applying power to the ASI, make these checks:

1. Check that the module address is set.
2. Be sure the dipshunts in the MMU's slave expander bus are installed.
3. Check that the dipswitch on Termination Module NIAI04 is set.
4. Verify I/O cabling connections.

---

## CONFIGURING INPUTS

Figure A-1 shows the TM dipswitch settings for the IMASI02. Be sure to recheck the dipswitches before you install the NIAI04. The switches may be changed during installation.

**NOTE:** In order for the ASI to communicate with a smart transmitter, a jumper must be added between the minus (-) and system common terminals or S4 on the NIAI04 must be closed.

---

## WIRING CONNECTIONS AND CABLING

With the ASI installed, connect either the NKTMO1 or NKTU02 termination cable from P1 on the TM to P3 on the ASI. Figure A-2 shows the termination module cabling for the IMASI02.

Application/ Signal Type	Dipswitch Configuration <sup>1</sup>	Connecting Cable
System Powered		NKTM01 or NKTU02
Externally Powered		
Single Ended Voltage		
Differential Voltage		
Above Applications 4 - 20 mA 1 - 5 VDC 0 - 1 VDC 0 - 5 VDC 0 - 10 VDC ± 10 VDC	S16 ONLY  T00692A	

<sup>1</sup>1 - 8 represent switch positions on dipswitches S1 - S15, where 0 is OPEN and 1 is CLOSED.

Figure A-1. Dipswitch Settings for IMASI02

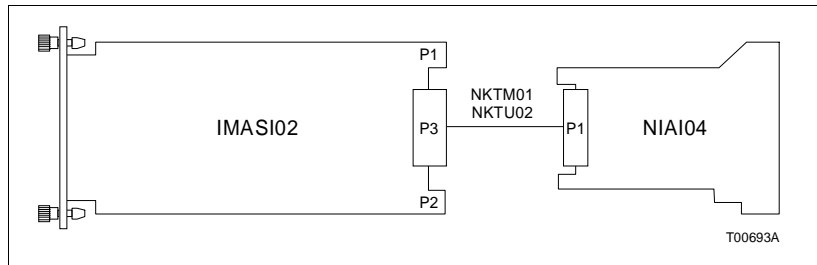

Figure A-2. Cable Connections

---

# APPENDIX B - (IMASM01) ANALOG SLAVE MODULE

---

## INTRODUCTION

The Analog Slave Module (IMASM01) uses an NIAI04 for termination. Dipswitches on the NIAI04 Termination Module configure the 16 analog inputs for the ASM. The ASM accepts inputs of 4 to 20 milliamps and 0 to 1 VDC, 1 to 5 VDC, 0 to 5 VDC, 0 to 10 VDC, -10 to +10 VDC.

---

## SETUP/INSTALLATION

Before applying power to the ASM, make these checks:

1. Check that the module address is set.
2. Be sure the dipshunts in the MMU's slave expander bus are installed.
3. Check that the dipswitch on Termination Module NIAI04 is set.
4. Verify I/O cabling connections.

---

## CONFIGURING INPUTS

Figure B-1 shows the termination unit dipswitch settings for the ASM. Be sure to recheck the dipswitches before you install the NIAI04. The switches may be changed during handling.

---

## WIRING CONNECTIONS AND CABLING

With the ASM installed, connect either the NKTM01 or NKTU02 termination cable from P1 on the TM to P3 on the ASM. Figure B-2 shows the termination module cabling for the ASM.

Application/ Signal Type	Dipswitch Configuration <sup>1</sup>	Connecting Cable
System Powered		NKTU02 or NKTM01
Externally Powered		
Single Ended Voltage		
Differential Voltage		
Above Applications 4 - 20 mA 1 - 5 VDC 0 - 1 VDC 0 - 5 VDC 0 - 10 VDC ± 10 VDC	S16 ONLY  T00694A	

<sup>1</sup>1 - 8 represent switch positions on dipswitches S1 - S15, where 0 is OPEN and 1 is CLOSED.

Figure B-1. Dipswitch Settings for IMASM01

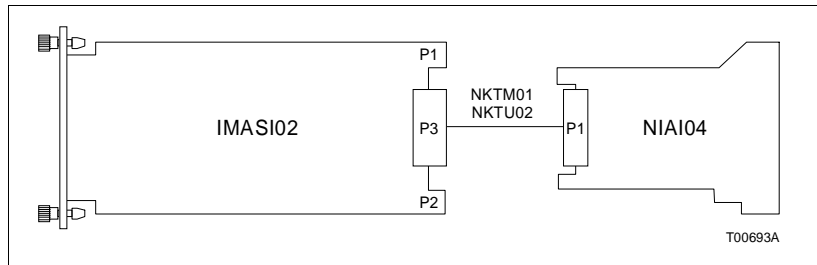

Figure B-2. Cable Connections

Visit Elsag Bailey on the World Wide Web at <http://www.bailey.com>

---

Our worldwide staff of professionals is ready to meet *your* needs for process automation.  
For the location nearest you, please contact the appropriate regional office.

**AMERICAS**

29801 Euclid Avenue  
Wickliffe, Ohio USA 44092  
Telephone 1-216-585-8500  
Telefax 1-216-585-8756

**ASIA/PACIFIC**

152 Beach Road  
Gateway East #20-04  
Singapore 189721  
Telephone 65-391-0800  
Telefax 65-292-9011

**EUROPE, AFRICA, MIDDLE EAST**

Via Puccini 2  
16154 Genoa, Italy  
Telephone 39-10-6582-943  
Telefax 39-10-6582-941

**GERMANY**

Graefstrasse 97  
D-60487 Frankfurt Main  
Germany  
Telephone 49-69-799-0  
Telefax 49-69-799-2406