

# Conceptpower DPA™ S2 30 - 250 kVA User Manual



# Contact us

[www.abb.com/ups](http://www.abb.com/ups)  
ups.sales@ch.abb.com

© Copyright ABB. All rights reserved.  
Specification subjects to change  
without notice.



# GENERAL CONTENTS OF THE USER MANUAL CONCEPTPOWER DPA™ S2

## 0 SECTION-0:

### 0.1 FOREWORD

### 0.2 CONCEPTPOWER DPA™ S2 SYSTEM DESCRIPTION

## 1 SECTION-1:

### 1.1 MECHANICAL CHARACTERISTICS MX-FRAMES AND MODULES

### 1.2 SAFETY INSTRUCTIONS

- 1.2.1 GENERAL SAFETY INTRODUCTION
- 1.2.2 DESCRIPTION OF SYMBOLS USED IN THIS MANUAL
- 1.2.3 SYMBOLS, CONTROLS, AND INDICATORS
- 1.2.4 OPERATOR PRECAUTIONS
- 1.2.5 ENVIRONMENTAL CONSIDERATIONS
- 1.2.6 DECLARATION OF SAFETY CONFORMITY AND CE MARKING
- 1.2.7 INQUIRIES

### 1.3 SYSTEM DESCRIPTION

- 1.3.1 GENERAL SYSTEM DESCRIPTION
- 1.3.2 CONCEPTPOWER DPA™ S2 BASIC SYSTEM CONFIGURATION
- 1.3.3 QUALITY STANDARDS AND UPS CLASSIFICATION CODE
- 1.3.4 SINGLE/PARALLEL-MODULES OPERATION
- 1.3.5 SINGLE/MULTI-CABINET CONFIGURATIONS

### 1.4 DELIVERY - TRANSPORT - STORAGE

- 1.4.1 INTRODUCTION
- 1.4.2 RECEIPT OF THE UPS AND VISUAL INSPECTION
- 1.4.3 UNPACKING
- 1.4.4 NAMEPLATE AND IDENTIFICATION
- 1.4.5 BATTERIES AND STORAGE

### 1.5 SITE PLANNING AND POSITIONING

- 1.5.1 PLANNING BEFORE THE INSTALLATION
- 1.5.2 POSITIONING OF UPS AND BATTERY CABINET

### 1.6 ELECTRICAL INSTALLATION

- 1.6.1 PREPARATION FOR THE INPUT CABLING
- 1.6.2 INSTALLATION CHECKLIST

**2 SECTION-2:****2.1 BLOCK DIAGRAM**

- 2.1.1 WIRING AND BLOCK DIAGRAMS FOR ALL FRAMES AND MODULES
- 2.1.2 RECOMMENDED CABLE SECTIONS & FUSE RATINGS
- 2.1.3 BLOCK DIAGRAM CONCEPTPOWER DPA™

**2.2 FRONT VIEW**

- 2.2.1 FRONT VIEW OF MX-FRAMES

**2.3 BATTERY CONNECTIONS**

- 2.3.1 INTERNAL BATTERY MODULES
- 2.3.2 EXTERNAL BATTERY CABINET AND BATTERY CONNECTION

**3 SECTION-3:****3.1 INTERFACING**

- 3.1.1 SMART PORT JD1 ON EACH MODULE (SERIAL RS 232/SUB D9/MALE)
- 3.1.2 CUSTOMER INTERFACE AND DRY PORTS (VOLT-FREE CONTACTS)
- 3.1.3 JD11 / RS232 COMPUTER INTERFACE
- 3.1.4 JD12 / RS232 INTERFACE FOR MULTIDROP
- 3.1.5 USB/2 COMPUTER INTERFACE

**4 SECTION-4:****4.1 OPERATION**

- 4.1.1 COMMISSIONING
- 4.1.2 CONTROL PANEL
- 4.1.3 DESCRIPTION OF THE LCD
- 4.1.4 OPERATING MODES

**5 SECTION-5:****5.1 OPERATION-PROCEDURES**

- 5.1.1 START-UP PROCEDURE
- 5.1.2 SHUTDOWN PROCEDURE
- 5.1.3 LOAD TRANSFER: FROM INVERTER OPERATION TO MAINTENANCE BYPASS
- 5.1.4 LOAD TRANSFER: FROM MAINTENANCE BYPASS TO INVERTER OPERATIONS

**5.2 REPLACEMENT OF UPS-MODULE**

- 5.2.1 REPLACEMENT OF UPS-MODULE IN SINGLE-MODULE SYSTEMS
- 5.2.2 REPLACEMENT OF UPS-MODULE IN REDUNDANT MULTI-MODULE SYSTEM
- 5.2.3 REPLACEMENT OF A MODULE IN CAPACITY MULTI-MODULE SYSTEM

**6 SECTION-6:****6.1 MULTI-CABINET CONFIGURATION**

- 6.1.1 CONCEPT OF MULTI-CABINET CONFIGURATION
- 6.1.2 INSTALLATION INSTRUCTIONS
- 6.1.3 COMMISSIONING OF MULTI-CABINET CONFIGURATION

**7 SECTION-7:****7.1 MAINTENANCE**

- 7.1.1 USER RESPONSIBILITIES
- 7.1.2 PREVENTATIVE MAINTENANCE
- 7.1.3 DEEP BATTERY TEST
- 7.1.4 BATTERY MAINTENANCE, DISPOSAL AND RECYCLING

**8 SECTION-8:****8.1 TROUBLESHOOTING**

- 8.1.1 ALARMS
- 8.1.2 MENU, COMMANDS, EVENT LOG AND MEASUREMENTS,
- 8.1.3 FAULT IDENTIFICATION AND RECTIFICATION

**9 SECTION-9:****9.1 OPTIONS**

- 9.1.1 INTRODUCTION
- 9.1.2 REMOTE SHUTDOWN
- 9.1.3 GENERATOR ON FACILITIES
- 9.1.4 WAVEMON SHUTDOWN AND MANAGEMENT SOFTWARE
- 9.1.5 SNMP CARD/ADAPTER FOR NETWORK MANAGEMENT /REMOTE MONITORING

**10 SECTION-10: TECHNICAL DATA SHEET****10.1 CONCEPTPOWER DPA™ S2 SYSTEM DESCRIPTION****10.2 TECHNICAL CHARACTERISTICS**

- 10.2.1 MECHANICAL CHARACTERISTICS MX-FRAMES AND MODULES
- 10.2.2 POWER SELECTION TABLE CONCEPTPOWER DPA MODULES

**10.3 INPUT CHARACTERISTICS**

- 10.3.1 GRAPH: INPUT PF VERSUS % LOAD
- 10.3.2 GRAPH: INPUT DISTORTION THDI VERSUS % LOAD

**10.4 BATTERY CHARACTERISTICS****10.5 OUTPUT CHARACTERISTICS****10.6 ENVIRONMENTAL CHARACTERISTICS****10.7 STANDARDS****10.8 COMMUNICATION**

- 10.8.1 POWER MANAGEMENT DISPLAY (PMD)
- 10.8.2 MIMIC DIAGRAM
- 10.8.3 DISPLAY
- 10.8.4 CUSTOMER INTERFACES (TERMINALS X1...X4)
- 10.8.5 CUSTOMER INPUTS DRY PORTS: TERMINAL BLOCK X1
- 10.8.6 CUSTOMER OUTPUTS DRY PORTS: TERMINA BLOCKS X2, X3, X4

**10.9 OPTIONS**

- 10.9.1 SNMP CARD / WAVEMON MANAGEMENT SOFTWARE
- 10.9.2 BATTERY CABINETS

**10.10 BATTERY AUTONOMIES**

- 10.10.1 MX MODULES: EXAMPLES OF INTERNAL BATTERY AUTONOMY
- 10.10.2 MX MODULES: EXAMPLES OF EXTERNAL BATTERY AUTONOMY

**10.11 INSTALLATION PLANNING**

- 10.11.1 HEAT DISSIPATION PER MODULE WITH NON-LINEAR LOAD

**10.12 WIRING AND BLOCK DIAGRAMS FOR ALL FRAMES AND MODULE**

- 10.12.1 TERMINAL CONNECTIONS OVERVIEW
- 10.12.2 SINGLE FEED INPUT
- 10.12.3 DUAL FEED INPUT

**0.1 FOREWORD**

The UPS System operates with mains, battery or bypass power. It contains components that carry high currents and voltages. The properly installed UPS System is grounded to earth and IP 20 rated against electrical shock and foreign objects. Installation and service have to be done by the manufacturer's qualified technicians or their certified service partners.

**OPERATIONS INSIDE THE UPS MUST BE PERFORMED  
BY A SERVICE ENGINEER FROM THE MANUFACTURER  
OR FROM AN AGENT CERTIFIED BY THE  
MANUFACTURER.**

This user manual contains guidelines to check delivery, installing and commissioning of the UPS and is intended for people who plan the installation, install, commission and use or service the UPS. The reader is expected to know the fundamentals of electricity, wiring, electrical components and electrical schematic symbols

**CAREFULLY READ THE USER MANUAL BEFORE  
OPERATING OR WORKING ON THE UPS.**

## 0.2 CONCEPTPOWER DPA™ S2 SYSTEM DESCRIPTION

In environments that demand zero downtime, continuous power protection availability is essential. In order to respond to today's dynamic IT and process-related environments that experience daily change through new server technologies, migration and centralization, resilient and easily adaptable power protection concepts are required.

CONCEPTPOWER DPA™ S2 is the foundation for continuous power protection availability of network-critical infrastructures in enterprise data centers where business continuity has paramount importance and in process control environment where manufacturing continuity is essential.

CONCEPTPOWER DPA™ S2'S is a second generation high-power-density (HPD), leading-edge double-conversion power protection technology that has standardized on a modular component approach which helps speed deployment, improve adaptability and increase system availability while reducing total cost of ownership.

CONCEPTPOWER DPA™ S2'S is a unique on-demand architecture that integrates the power rack, power distribution unit, back-up battery rack and monitoring and management solutions to allow easy selection of optimized configurations.

CONCEPTPOWER DPA™ S2'S (Distributed Parallel Architecture) provides highest availability, unmatched flexibility and at the same time lowest cost of ownership in IT environments.

This Technical Specification provides detailed technical information on the mechanical, electrical and environmental performance of the CONCEPTPOWER DPA™ S2 that can support to give answers to tender and end-user requirements. The CONCEPTPOWER DPA™ S2 was designed to respond to the most stringent safety, EMC and other important UPS standards.

CONCEPTPOWER DPA™ S2 is a rack-mountable modular design. It offers 3-types of Racks (Frames) and 3 types of DPA-Modules to accommodate a wide range of power requirements.

The three MX-Frames; Classic DPA-50, Triple DPA-150, Upgrade DPA-250 can accommodate the three (3) MX-DPA-Modules types DPA 30 or 40 or 50 of: 30kVA/24kW - 40kVA/32kW - 50kVA/40kW power.

### Key Features of CONCEPTPOWER DPA S2 Modules:



- Highest Availability  
Modular, Decentralized Parallel Architecture (DPA) *Near-zero down time*
- High Power Density (up to 342kW / m<sup>2</sup>),  
Small Footprint *Space-saving of expensive floor space*
- Blade-server-friendly power  
Full power from 0.9 lead to 0.8 lag *No de-rating with leading PF loads*
- High Efficiency even with partial loads  
Efficiency up to 95.5%  
(depending on Module power and type of load) *Energy cost saving during UPS-life-cycle*
- Very low input current distortion THDi  
THDi = < 3.0 % on 100 % loading *Gen-set power and installation cost saving*



# CONTENTS SECTION-1

<b>1.1</b>	<b>MECHANICAL CHARACTERISTICS MX-FRAMES AND MODULES .....</b>	<b>2</b>
<b>1.2</b>	<b>SAFETY INSTRUCTIONS.....</b>	<b>3</b>
1.2.1	GENERAL SAFETY INTRODUCTION .....	3
1.2.2	DESCRIPITON OF SYMBOLS USED IN THIS MANUAL.....	3
1.2.3	Symbols, Controls, and Indicators .....	4
1.2.4	OPERATOR precautions .....	5
1.2.5	Environmental Considerations.....	6
1.2.6	Declaration of Safety conformity and CE marking.....	6
1.2.7	Inquiries .....	6
<b>1.3</b>	<b>SYSTEM DESCRIPTION .....</b>	<b>7</b>
1.3.1	GENERAL SYSTEM DESCRIPTION .....	7
1.3.1.1	Feature : Unique “Hot Swappable” Modules .....	7
1.3.1.2	Feature : Advanced-Booster Technology .....	7
1.3.1.3	Feature : Flexible Battery Management (FBM) .....	8
1.3.1.4	Feature : DPA Technology - Decentralized Parallel Architecture.....	8
1.3.2	Conceptpower DPA™ S2 basic system configuration.....	9
1.3.3	Quality Standards and ups classification code .....	9
1.3.4	Single/Parallel-Modules operation .....	10
1.3.5	Single/Multi-Cabinet Configurations .....	10
<b>1.4</b>	<b>DELIVERY - TRANSPORT - STORAGE .....</b>	<b>11</b>
1.4.1	Introduction .....	11
1.4.2	Receipt of the UPS and visual inspection.....	11
1.4.3	Unpacking .....	12
1.4.4	Nameplate and identification .....	13
1.4.5	Batteries And Storage.....	13
1.4.5.1	Storage of battery .....	14
1.4.5.2	Storage of UPS .....	14
<b>1.5</b>	<b>SITE PLANNING AND POSITIONING .....</b>	<b>14</b>
1.5.1	PLANNING BEFORE THE INSTALLATION.....	14
1.5.2	POSITIONING OF UPS AND BATTERY CABINET .....	15
1.5.2.1	Final Transport.....	15
1.5.2.2	Positioning .....	16
<b>1.6</b>	<b>ELECTRICAL INSTALLATION.....</b>	<b>17</b>
1.6.1	PREPARATION FOR THE INPUT CABLING .....	18
1.6.1.1	Earthing and Connection of Mains Supply .....	18
1.6.1.2	Single Input Feed.....	19
1.6.1.3	Dual Input Feed .....	19
1.6.1.4	Preparation for the Output Cabling.....	19
1.6.1.5	Connection of the Load.....	20
1.6.2	Installation Checklist .....	21

## 1.1 MECHANICAL CHARACTERISTICS MX-FRAMES AND MODULES

CONCEPTPOWER DPA		CLASSIC DPA-50	TRIPLE DPA-150	UPGRADE DPA-250
MX - FRAMES				
Configuration accommodates:	Max.	1 module (30-50kVA) and 280 x 7/9Ah batteries	3 modules (30-50kVA) and 240x 7/9Ah batteries	5 modules (30-50kVA) and no batteries
Max. Power connection	kVA	50	150	250
Dimensions (WxHxD)	mm	730x1650x800	730x1975x800	730x1975x800
Weight of Empty Frame w/o modules and w/o batteries	kg	262	239	205
Weight of Frame with modules and w/o batteries	kg	305 up to 309 (with 1 Module)	368 up to 379 (with 3 Modules)	420 up to 439 (with 5 Modules)
Audible noise at 1m from front, 100% / 50% Load	dBA	70 / 63	74 / 67	76 / 69
Colours		Front door silver :RAL 9007 + black (inlets) Side walls/top: Graphite grey (Pulverlacke No. 4222903402 serie 09RCCAT1)		

MX- DPA MODULES			DPA 30 S2	DPA 40 S2	DPA 50 S2
Output Apparent Rated Power	KVA		30	40	50
Output Active Rated Power	KW		24	32	40
Output Power with Load PF=1	KVA / KW		24 / 24	32 / 32	40 / 40
Dimensions (WxHxD)	mm		663 x 225 x 720		
Weight UPS Module	kg		43.1	45.3	46.8
Colours			Front : Graphite grey (Pulverlacke No. 4222903402 serie 09RCCAT1)		

## 1.2 SAFETY INSTRUCTIONS

### 1.2.1 GENERAL SAFETY INTRODUCTION

The UPS System operates with mains, battery or bypass power. It contains components that carry high currents and voltages. The properly installed UPS System is grounded to earth and IP 20 rated against electrical shock and foreign objects. Installation and service have to be done by the manufacturer's qualified technicians or their certified service partners.

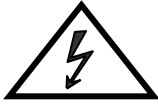

**WARNING!**

**OPERATIONS INSIDE THE UPS MUST BE PERFORMED BY A SERVICE ENGINEER FROM THE MANUFACTURER OR FROM AN AGENT CERTIFIED BY THE MANUFACTURER.**

This user manual contains guidelines to check delivery, installing and commissioning of the UPS and is intended for people who plan the installation, install, commission and use or service the UPS. The reader is expected to know the fundamentals of electricity, wiring, electrical components and electrical schematic symbols



**NOTE!**

**CAREFULLY READ THE USER MANUAL BEFORE OPERATING OR WORKING ON THE UPS.**

### 1.2.2 DESCRIPITON OF SYMBOLS USED IN THIS MANUAL



**WARNING!**

**THERE IS DANGER OF AN ELECTRICAL IMPACT**



**NOTE!**

**READ THE INFORMATION, IN ORDER TO AVOID EQUIPMENT DAMAGES**



**HEAVY!**

**THE WEIGHT OF A UPS MODULE CAN REACH 50KG, THEREFORE IT CAN BE LIFTED ONLY BY 2 PERSON**

### 1.2.3 Symbols, Controls, and Indicators



#### PROTECTIVE GROUNDING TERMINAL

A terminal which must be connected to earth ground prior to making any other connection to the equipment.



A terminal to which or from which a direct current or voltage may be applied or supplied.



This symbol indicates the word “phase”.



ON The principal power switch is in the “ON” position



OFF The principal power switch is in the “OFF” position.



C CAUTION: REFER TO MANUAL  
Refer to the Operator’s Manual for more information



DANGER: RISK OF ELECTRIC SHOCK  
There is a risk of electric shock present, and you should observe associated warnings. The UPS contains high voltages.



### 1.2.4 OPERATOR precautions

The only user operations permitted are:

- Use of the LCD control panel (LCD Display) and of the Maintenance Bypass
- Start up and shut down of the UPS of the user field (excluding the commissioning start up)
- Operation of additional connectivity modules:
- SNMP adapters and their software
- Modem/GSM or Modem/Ethernet adapters and their software
- Multidrop Kit for paralleling connectivity information between multi-frame configurations

The user must follow the precautions and only perform the described operations. Also in these measures the operator of the USP System must adhere to the instructions in this manual. Any deviations from the instructions could be dangerous to the user or cause accidental load loss.

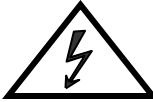
**THE MANUFACTURER DOES NOT TAKE ANY RESPONSIBILITY FOR DAMAGES CAUSED THROUGH WRONG MANIPULATIONS OF THE UPS SYSTEM.**

	<p><b>WARNING!</b></p>	<p>IT IS PROHIBITED TO REMOVE ANY SCREWS FROM THE UPS SYSTEM OR FROM THE BATTERY CABINET. THERE IS A DANGER OF ELECTRICAL SHOCK.</p>
	<p><b>WARNING!</b></p>	<p>HIGH FAULT CURRENTS (LEAKAGE CURRENTS): BEFORE CONNECTING THE MAINS YOU MUST ENSURE THAT THERE IS A PROPER EARTH CONNECTION!</p>
	<p><b>WARNING!</b></p>	<p>THE USER MUST DISPLAY A WARNING SHIELD ON ALL PRIMARY UPS CIRCUIT BREAKERS. THE SERVICE PERSONNEL HAS TO BE INFORMED ABOUT DANGEROUS VOLTAGES. THE WARNING PANELS MUST CONTAIN THE FOLLOWING TEXT: “ BEFORE STARTING WITH THE MAINTENANCE WORK ON THE CIRCUIT BREAKERS MAKE SURE THE UPS IS ISOLATED</p>

**1.2.5 Environmental Considerations**

	<p><b>THIS IS A PRODUCT FOR COMMERCIAL AND INDUSTRIAL APPLICATION IN THE SECOND ENVIRONMENT AS DEFINED IN IEC/EN 62040-2 CHAPTER 4 – INSTALLATION RESTRICTIONS OR ADDITIONAL MEASURES MAY BE NEEDED TO PREVENT DISTURBANCES.</b></p>
---	--

The UPS must be installed according to the recommendations in this manual. To operate the UPS at peak efficiency, your installation site should meet the environmental parameters outlined in this manual. Excessive amount of dust in the operating environment of UPS may cause damage or lead to malfunction. The UPS should be always protected from the outside weather and sunshine. If you intend to operate the system at an altitude higher than 1000 meters, contact your local sales or service office for important information about high altitude operation. The operating environment must meet the weight, airflow, size and clearance requirements specified in the technical datasheet.

Under no circumstances the UPS should be installed in an airtight room, in the presence of flammable gases, or in an environment exceeding the specification.

The basic environmental requirements of the UPS system are:

- Ambient Temperature Range: 0 to +40°C (32 – 104°F)
- Recommended Operating Range: +20 to +25°C (68 – 77°F)
- Maximum Relative Humidity: 95% (non-condensing)

The UPS cabinet uses forced air cooling to regulate internal component temperature. Air inlets are in the bottom sides and front of the cabinet, and outlets in the rear of the cabinet. You must allow clearance in back of the cabinet for proper air circulation. Refer to 1.5.2.2 POSITIONING for clearance requirements.

**1.2.6 Declaration of Safety conformity and CE marking**

The product has the CE marking in compliance with the following European directives:

- Low Voltage Directive: 2006/95/EC
- EMC Directive: 2004/108/EC



	Product Standards	Standards
Safety	IEC/EN 62040-1	IEC/EN 60950-1
Electromagnetic Compatibility (EMC)	IEC/EN 62040-2 Emission cat. C3 Immunity cat. C3	IEC/EN 61000-6-2 IEC/EN 61000-6-4 IEC/EN 61000-4-2 IEC/EN 61000-4-3 IEC/EN 61000-4-4 IEC/EN 61000-4-5 IEC/EN 61000-4-6
Performance	IEC/EN 62040-3	

**1.2.7 Inquiries**

Address inquiries about the UPS and battery cabinet to the local office or agent certified by the manufacturer. Please note the type code and the serial number of the equipment and contact your nearest agent certified by the manufacturer.

The Code and the serial no. are shown on the nameplate see 1.4.4 Nameplate and identification

## 1.3 SYSTEM DESCRIPTION

The product described in this manual is a transformerless Uninterruptible Power System (UPS). It is a true online, continuous duty, double conversion, solid state, three-phase system, providing conditioned and uninterruptible AC power to protect the customer's load from all nine power failures.

### 1.3.1 GENERAL SYSTEM DESCRIPTION

The UPS's are used to protect sensitive equipment and prevent loss of valuable electronic information, minimise equipment downtime, and minimise the adverse effect on production equipment due to unexpected power problems.

The UPS system continually monitors incoming electrical power and removes the surges, spikes, sags, and other irregularities that are inherent in commercial utility power. Working with a building's electrical system, the UPS system supplies clean, consistent power that sensitive electronic equipment requires for reliable operation. During brownouts, blackouts, and other power interruptions, batteries provide emergency power to safeguard operation.

The UPS system is housed in single freestanding cabinets. The cabinets line up and match in style and colour, and have safety shields behind the doors for hazardous voltage protection.

#### 1.3.1.1 Feature : Unique "Hot Swappable" Modules

The unique Hot Swappable feature of the Modules indicates the ability to insert and extract the electronic/power modules from a larger assembly while it is powered (hot). The hot swappable design allows live powered modules to be attached to and removed from a powered set without causing disturbance to the operation of the load and without need to go to bypass.

#### 1.3.1.2 Feature : Advanced-Booster Technology

Traditional input THD filters are no longer needed with this UPS product. The build-in advanced booster technology of UPS modules provides perfect sinusoidal input power quality at 0.99 input power factor with harmonic content less than 3-4% THD(i). This leads to more reliable total system operation and savings in generator and transformer sizing as losses in the windings are minimised.

Due to the active front booster, regulating each individual phase, the UPS is comparable to a clean resistor load (unity) from the mains perspective. Thus, the high input power factor provides minimised cabling and fusing costs due to no reactive power consumption. The low harmonic currents are due to high input power factor and provide the benefits:

- No additional losses in wires and cables
- No extra heating of transformers and generators with shortened service life
- No over sizing of generators
- No false circuit breaker tripping and malfunction
- No erratic operation of computers, telecommunication, monitors, electronic test equipment etc.
- No Resonance with power factor correction capacitors

### 1.3.1.3 Feature : Flexible Battery Management (FBM)

The Flexible Battery Management (FBM) has been designed in all UPS products with the goal to avoid the deterioration of battery age. The FBM – Key Features protect the battery from environmental negative impacts (high temperature and false manipulations) and avoid deterioration of battery life by advanced management of battery charging and preventive failure diagnostics. The implemented features result in benefits not only for the end user, but also to the environment. The battery user will be required to replace his batteries less often. This translates into financial and environmental benefits. Last but not least a well protected and managed battery is a healthy battery and hence it enhance the overall availability of the UPS system.

The major benefits are:

- AC-Ripple free battery charging due to DC-DC charger separated from the rectifier and inverter
- Wide range of number of battery blocks, 42-50 blocks of 12V, temperature dependent.
- UPS'S wide input voltage window tolerance extends the battery life due to less discharge cycles
- Battery discharge protection caused by load jumps
- Proactive battery protection from false manipulations and inadequate charging voltages
- Proactive battery failure detection thanks to Advanced Battery Diagnosis (ABD) - Algorithm
- User selectable battery tests
- Optional temperature compensated charging to enhance battery life

Hence, the function of FBM system is to prolong the battery life considerably compared to traditional systems. In a traditional online UPS the inverter also causes ripple-current to be fed to batteries causing corrosion.

### 1.3.1.4 Feature : DPA Technology - Decentralized Parallel Architecture

The UPS product features DPA paralleling technology that provides N+X redundancy without introducing a single-point-of-failure. The products utilizing the DPA technology are completely autonomous by means of individual Power Units, Bypasses, CPU's, Control Panels and separate battery configuration for each single module.

The DPA technology makes it more reliable than traditional paralleling techniques. A parallel UPS system means the linking together of two or more UPS units in parallel so that in the unlikely event one fails the other can automatically take up the load. Traditionally a parallel redundancy configuration is achieved by having a random or fixed master-slave relationship among the UPS units. This master logic gives out individual commands to all the slaves units. Unfortunately this can lead to a single-point-of-failure for the whole system because if the master logic or communication to slaves fails, and causes the whole UPS system to be in trouble.

The DPA technology was developed as a Multi-Master logic concept with separated independent regulation and logic buses to allow parallel capacity system and to maintain the highest system availability. An industry leading paralleling technology in its own right, the DPA technology enables you to set up a parallel redundant system giving you 100% conditioned power at all times. Its unique decentralized design eliminates the system level single point of failure inherent in traditional parallel UPS, and exponentially increases the reliability of the overall system.

DPA technology allows up to ten UPS modules to cover the same load in parallel and redundant configuration. No vulnerable master logic is needed in this design. It provides automatic load sharing and module level redundancy with nothing other than the power connecting to the Conceptpower DPA™ S2 version of UPS modules.



### 1.3.2 Conceptpower DPA™ S2 basic system configuration

The UPS system is housed in single freestanding cabinets. The cabinets line up and match in style and colour, and have safety shields behind the doors for hazardous voltage protection. The following basic UPS systems configuration are available:



CLASSIC- DPA-50



TRIPLE-DPA-150



UPGRADE-DPA-250

UPS Frame Type	Module no.	Packed Weight with DPA 30 w/o Batt. in kg	Packed Weight with DPA 40 w/o Batt. in kg	Packed Weight with DPA 50 w/o Batt. in kg	Packed Dimension mm	Unpacked Weight with DPA 30 w/o Batt. in kg	Unpacked Weight with DPA 40 w/o Batt. in kg	Unpacked Weight with DPA 50 w/o Batt. in kg	Unpacked Dimension mm
<b>Module</b>		43.1	45.3	46.8	WxHxD	43.1	45.3	46.8	WxHxD
<b>CLASSIC-DPA-50</b>	1	328	330	332	890x1800x920	305	307	309	730x1650x800
<b>TRIPLE-DPA-150</b>	1	307	309	311	890x2120x920	282	284	286	730x1975x800
	2	350	355	358	890x2120x920	325	330	333	730x1975x800
	3	393	400	404	890x2120x920	368	375	379	730x1975x800
<b>UPGRADE-DPA-250</b>	1	273	275	277	890x2120x920	248	250	252	730x1975x800
	2	316	321	324	890x2120x920	291	296	299	730x1975x800
	3	359	366	370	890x2120x920	334	341	345	730x1975x800
	4	402	411	417	890x2120x920	377	386	392	730x1975x800
	5	446	457	464	890x2120x920	421	432	439	730x1975x800

### 1.3.3 Quality Standards and ups classification code

The Conceptpower DPA™ S2 will provide your critical equipment with a steady and reliable power supply for many years.

The unique and modular UPS Conceptpower DPA™ S2 belongs to the newest generation of midrange 3phase UPS-Systems. High reliability, low operating cost and excellent electrical performance are only some of the highlights of this innovative UPS solution.

The criteria and methods implemented for the design and manufacture correspond to the most stringent quality standards.

The manufacturer is certified successfully in every areas according to the model of the International Standard ISO9001/EN 29001. The Certification of UPS with the operating performance according to the Norm IEC 62 040-3 and VDE 0558 Part 530 is accomplished.

With it the UPS has the **Classification Code VFI-SS-111**.

	Product Standards	Standards
Safety	IEC/EN 62040-1	IEC/EN 60950-1
Electromagnetic Compatibility EMC	IEC/EN 62040-2 Emission cat. C3 Immunity cat. C3	IEC/EN 61000-6-2 IEC/EN 61000-6-4 IEC/EN 61000-4-2 IEC/EN 61000-4-3 IEC/EN 61000-4-4 IEC/EN 61000-4-5 IEC/EN 61000-4-6
Performance	IEC/EN 62040-3	

**1.3.4 Single/Parallel-Modules operation**

The Conceptpower DPA™ S2 has unique paralleling features. We distinguish: Single or Parallel-Modules

**A) Single-Module**



CLASSIC DPA-50    TRIPLE DPA-150    UPGRADE DPA-250    1 single module

If a configuration consists of one single Module it is defined as a Single-Module Configuration even being in different cabinets like CLASSIC DPA-50, TRIPLE DPA-150, UPGRADE DPA-250 with a single Module.

**B) Parallel-Module:**



TRIPLE DPA-150

A Parallel-Module is a Module that is operating in parallel with other equivalent Modules, but still within the same cabinet (e.g. TRIPLE DPA-150) using the DPA technology

**1.3.5 Single/Multi-Cabinet Configurations**

**Single-Cabinet Configuration:**



A single-cabinet configuration means, that there are no cabinets operating in a chain.

**Multi-Cabinet Configurations:**



It is possible to parallel Conceptpower DPA™ S2 CLASSIC DPA-50, TRIPLE DPA-150, UPGRADE DPA-250 Cabinets into a Multi-Cabinet Configuration (including total up to 30 Modules) in order to increase the number of paralleled Modules.

## 1.4 DELIVERY - TRANSPORT - STORAGE

### 1.4.1 Introduction

This chapter contains all the necessary information for the correct unpacking, positioning, cabling and installation of the UPS

The UPS and accessories are delivered on a specifically designed pallet that is easy to move with a forklift or a pallet jack. Keep the UPS always in upright position and do not drop the equipment. Do not either stack the pallets because of high-energy batteries involved and the heavy weight



**IF THE UPS IS NOT IMMEDIATELY INSTALLED THE FOLLOWING GUIDELINES MUST BE FOLLOWED:**

**TRANSPORT:**

**UPS CABINETS AND/OR BATTERY CABINET CAN FALL OVER. USE THE SHIPPING BRACKETS ON THE REAR AND FRONT TO SECURE THE CABINETS. DO NOT TILT THEM MORE THAN 10° FROM VERTICAL, OTHERWISE CABINETS MAY TIP OVER.**

**POTENTIAL DANGERS:**

- TILTING THE CABINET MIGHT DAMAGE THE SYSTEM AND THEREFORE SHOULD NO LONGER BE CONNECTED TO THE MAINS.
- WEIGHT OF THE UPS SYSTEM COULD CAUSE SERIOUS INJURIES TO PERSONS OR ANYTHING IN THE SURROUNDING AREA.

**STORAGE:**

- THE UPS SHOULD BE STORED IN THE ORIGINAL PACKING AND SHIPPING CARTON
- THE RECOMMENDED STORING TEMPERATURE FOR THE UPS SYSTEM AND BATTERIES IS BETWEEN +20 °C AND +25°C.
- THE UPS SYSTEM AND THE BATTERIE SETS MUST BE PROTECTED FROM HUMIDITY < 95% (NON-CONDENSING)

### 1.4.2 Receipt of the UPS and visual inspection

Upon receiving the UPS, carefully examine the packing container and the UPS for any sign of physical damage. The outside 'Tip&Tel' ("FRAGILE" and "ARROW") indicator should be intact if the equipment has been transported in the upright position. In case of rupture or suspect inform immediately:

- The carrier and
- The manufacturer.

Ensure that the received UPS corresponds to the material indicated in the delivery note.

The packing container of the **UPS** protects it from mechanical and environmental damage. To increase its protection the UPS is wrapped with a plastic sheet.



**VISIBLE TRANSPORT DAMAGES MUST BE CLAIMED TO THE CARRIER IMMEDIATELY AFTER RECEIPT !!**

**OTHER CLAIM FOR SHIPPING DAMAGE MUST BE FILED IMMEDIATELY TOO AND THE CARRIER MUST BE INFORMED WITHIN 7 DAYS OF RECEIPT OF THE EQUIPMENT. THE PACKING MATERIALS SHOULD BE STORED FOR FURTHER INVESTIGATION.**

### 1.4.3 Unpacking

Unpack the equipment by removing the packing and shipping materials. Make a visual inspection and check that 'Tip&Tel' indicator ( "FRAGILE" and "ARROW") on the packing container is intact.

Perform the following steps to unpack the UPS equipment from the pallet and make sure that the floor surface is solid and suitable for the wheeling and heavy weight:

- 1) Examine the UPS for any sign of damage. Notify your carrier or supplier immediately if damage is apparent;
- 2) Remove the plastic cover from the UPS;
- 3) Remove pallet from the UPS;

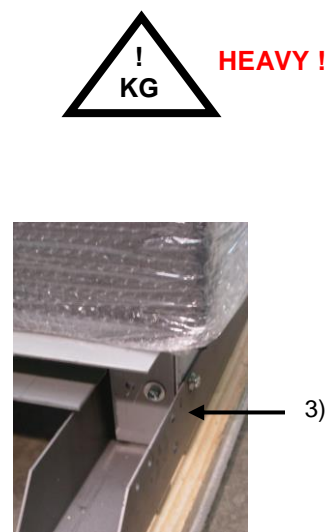

**1.4.4 Nameplate and identification**

The technical specifications of the Equipment are provided on the nameplate, which is situated at the front of the UPS. Check if it corresponds to the purchased material mentioned in the delivery note.

<b>ABB</b>		<b>CE</b>	
Conceptpower DPA		Made in Switzerland	
Output Power:	kVA	Output Power:	kW
Input Voltage:	V	Output Voltage:	V
Input Current:	A	Output Current:	A
Icw:	kA	Input / Output Freq.:	Hz
UPS Serial No. <input style="width: 40px; height: 20px;" type="text"/>		Production Date <input style="width: 40px; height: 20px;" type="text"/>	

TYPE	PRODUCT DESCRIPTION	DIMENSIONS
DPSxxxx	Conceptpower DPA Classic-50	Cabinet (730x1650x800mm)
DPTxxxx	Conceptpower DPA Triple-150	Cabinet (730x1975x800mm)
DPPxxxx	Conceptpower DPA Upgrade-250	Cabinet (730x1975x800mm)

**1.4.5 Batteries And Storage**

The standard batteries of the UPS are sealed, maintenance-free batteries, mounted usually in an external battery cabinet and will typically be connected when the UPS is commissioned.

The battery life depends very much on the ambient temperature. A temperature range between +20° and +25°C will achieve the optimum battery life.

If the UPS is delivered without batteries, the manufacturer is not responsible for any damage or malfunctioning caused to the UPS by incorrect wiring.



### 1.4.5.1 Storage of battery

The battery life depends very much on the ambient temperature. It is therefore important to follow the storage instructions/recommendation of the battery manufacturer. For long-term storage make sure that the battery is fully recharged every 6 months. Before and after storing, charge the battery.

Always store the batteries in a dry, clean, cool environment in their original packaging. If the packing container is removed protect the batteries from dust and humidity.

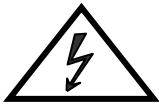

**WARNING!**

**SEALED BATTERIES MUST NEVER BE STORED IN A DISCHARGED OR PARTIALLY DISCHARGED STATE.**

**EXTREME TEMPERATURE, UNDER- AND OVERCHARGE AND OVERDISCHARGE WILL DESTROY BATTERIES!**

### 1.4.5.2 Storage of UPS

If you plan to store the UPS prior to use, keep the UPS unpacked in a dry, clean and cool storage room with an ambient temperature between (-25 °C to +70°C) and humidity of less than 95% non-condensing.

If the packing container is removed protect the UPS from dust.



**NOTE!**

**THE UPS SYSTEM, THE BATTERY CABINET AND THE BATTERIES ARE HEAVY AND MAY TIP DURING TRANSPORTATION CAUSING SERIOUS INJURY IF UNPACKING INSTRUCTIONS ARE NOT CLOSELY FOLLOWED.**

## 1.5 SITE PLANNING AND POSITIONING

### 1.5.1 PLANNING BEFORE THE INSTALLATION

The equipment must be installed and transported in a upright position. The equipment requires space to bottom/front and back to enable cooling airflow. It is required to arrange ventilation of the UPS room.

All parts of the UPS for service and user access are accessible from the front and rear, making it a service-friendly and maintenance-friendly UPS. Reserve enough space from the front (min. 600 mm)

The UPS should be located where:

- Humidity (< 95 % non-condensing) and temperature (+20° and +25°C ) are within prescribed limits
- Fire protection standards are respected
- Cabling can be performed easily
- Available front accessibility for service or periodic maintenance
- Requested air cooling flow should be granted
- The air conditioning system should have sufficient amount of air cooling needed to keep the max. room temperature rise at desired level:
- Dust or corrosive/explosive gases must be absent
- The place is vibration free
- Only front access is necessary for service and maintenance.
- If the UPS will be installed in bayed enclosures, partition walls have to be installed as well.

An ambient temperature of +20°C to +25°C is recommended to achieve a long life of the UPS and batteries. The cooling air entering the UPS must not exceed +40 °C. Avoid high ambient temperature, moisture and humidity. The floor material should be non-flammable and strong enough to support the heavy load.



## 1.5.2 POSITIONING OF UPS AND BATTERY CABINET

### 1.5.2.1 Final Transport

Check before transporting the surface loading and use a adequate forklift to move the equipment to the final position.



Fig. Floor surface must support loading



CLASSIC- DPA-50



TRIPLE-DPA-150



UPGRADE-DPA-250

UPS Frame Type	Module no.	Packed Weight with DPA 30 w/o Batt. in kg	Packed Weight with DPA 40 w/o Batt. in kg	Packed Weight with DPA 50 w/o Batt. in kg	Packed Dimension mm	Unpacked Weight with DPA 30 w/o Batt. in kg	Unpacked Weight with DPA 40 w/o Batt. in kg	Unpacked Weight with DPA 50 w/o Batt. in kg	Unpacked Dimension mm
<b>Module</b>		43.1	45.3	46.8	WxHxD	43.1	45.3	46.8	WxHxD
<b>CLASSIC-DPA-50</b>	1	328	330	332	890x1800x920	305	307	309	730x1650x800
<b>TRIPLE-DPA-150</b>	1	307	309	311	890x2120x920	282	284	286	730x1975x800
	2	350	355	358	890x2120x920	325	330	333	730x1975x800
	3	393	400	404	890x2120x920	368	375	379	730x1975x800
<b>UPGRADE-DPA-250</b>	1	273	275	277	890x2120x920	248	250	252	730x1975x800
	2	316	321	324	890x2120x920	291	296	299	730x1975x800
	3	359	366	370	890x2120x920	334	341	345	730x1975x800
	4	402	411	417	890x2120x920	377	386	392	730x1975x800
	5	446	457	464	890x2120x920	421	432	439	730x1975x800

**1.5.2.2 Positioning**

UPS designed for location in a restricted access location only!

**UPS :** A minimum 20 cm rear space from the UPS to an obstruction is recommended for proper cooling as the air enters at bottom/front and exits at unit rear (see Fig. 1. and 2.)

**External Battery :** It's recommended to install external battery cabinet(s) next to the UPS unit. The external battery can be placed on either side of the UPS unit, but it is recommended to install on left hand side.

Check before the installation that the battery voltage values in the type plate of the UPS and external battery cabinets are the same.

	<p><b>WARNING!</b></p>	<p><b>THE UPS CONTAINS HIGH DC VOLTAGES. A QUALIFIED PERSON MUST DO THE CONNECTIONS BETWEEN THE UPS AND THE EXTERNAL BATTERY CABINET(S). THE BATTERY CABINET IS CONNECTED ELECTRICALLY IN PARALLEL WITH THE INTERNAL BATTERIES OF THE UPS.</b></p>
---	------------------------	--

	<p><b>WARNING!</b></p>	<p><b>IF AVAILABLE, THE INTERNAL BATTERY HAS TO BE DISCONNECTED FIRST BECAUSE THE EXTERNAL BATTERY TERMINALS ARE HAZARDOUS DUE TO THE PARALLEL BATTERY STRING.</b></p>
---	------------------------	--

**Battery Racks:** External battery racks shall be sized to take the voltage drop in the cable into account. To obtain support and help contact the local office or agent certified by the manufacturer.

**Clearances needed to allow proper airflow on the UPS system and to allow door opening.**

Minimum clearances for single UPS				
UPS Model	A <sub>1</sub> (mm)	B <sub>1</sub> (mm)	C (°)	D (mm)
All (50, 150 and 250)	200	1000	115°	400

Minimum clearances for UPS + other cabinets in row				
UPS Model	A <sub>2</sub> (mm)	B <sub>2</sub> (mm)	C (°)	D (mm)
All (50, 150 and 250)	300	1000	115°	400

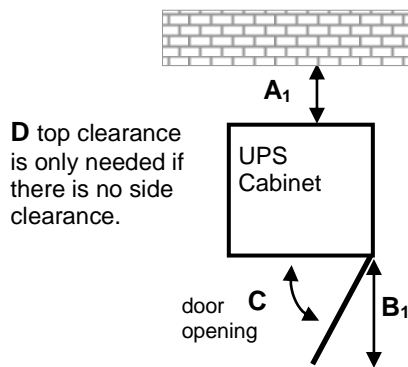

Figure 1: top view and indication of the minimum clearances for single UPS.

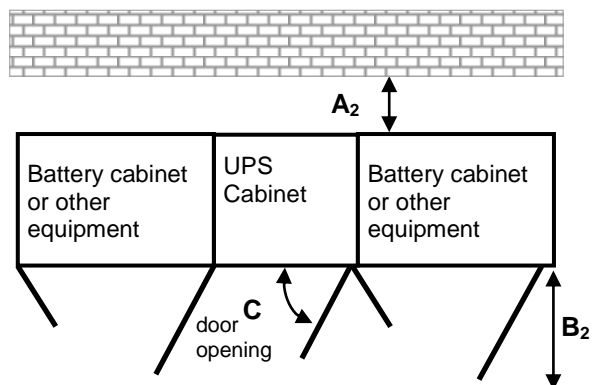
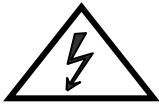

Figure 2: top view and indication of the minimum clearances for UPS + other cabinets in row .



## 1.6 ELECTRICAL INSTALLATION

The customer has to supply the wiring to connect the UPS to the local power source see Section 2, chapter 2.1.1. The electrical installation procedure is described in the following text. The installation inspection and initial start up of the UPS and extra battery cabinet must be carried out by a qualified service personnel such as a licensed service engineer from the manufacturer or from an agent certified by the manufacturer.



**WARNING!**

THE INSTRUCTION IN THIS USER MANUAL HAVE ALWAYS TO BE FOLLOWED IN ORDER TO AVOID INJURIES FROM ELECTRICAL IMPACTS.



**WARNING!**

ALL THE OPERATIONS IN THIS MANUAL MUST BE PERFORMED BY CERTIFIED ELECTRICIANS OR BY QUALIFIED INTERNAL PERSONNEL.

DO NOT OPERATE IN CASE OF PRESENCE OF WATER OR MOISTURE.

BY OPENING OR REMOVING THE UPS-COVERS YOU RUN RISK OF EXPOSURE TO DANGEROUS VOLTAGES

PHYSICAL INJURY OR DEATH MAY FOLLOW, OR DAMAGE MAY OCCUR TO THE UPS, OR THE LOAD EQUIPMENT IF THESE INSTRUCTIONS ARE IGNORED.

To ensure correct operation of the UPS and its ancillary equipment it is necessary to provide the mains cables with appropriate fuse protection. [See Section 2, chapter 2.1.2](#)

The UPS unit has the following power connections:

**Rectifier (In) :** **Three-phase** (1L1, 1L2, 1L3), Neutral (1N) and protective earth (PE) connection for the *rectifier input*

**Bypass (In) :** **Three-phase** (2L1, 2L2, 2L3), Neutral (2N) and protective earth (PE) connection for the *bypass if used as Dual Feed input*

**Load (Out) :** **Three-phase** (3L1, 3L2, 3L3), Neutral (3N) and protective earth (PE) connection for the *load output*

**External Battery :** **Plus (+), Common (N), Minus (-)** and protective earth (PE) connection for the *external batteries*



**INPUT NEUTRAL IS REQUIRED TO OPERATE THE RECTIFIER.**

In TN-S Systems, no 4-pole input switches or circuit breakers should be used. If you have to use for other reason a 4-pole switch, you have to be aware that, when open, the system - UPS and all downstream equipment - are floating against the PE.

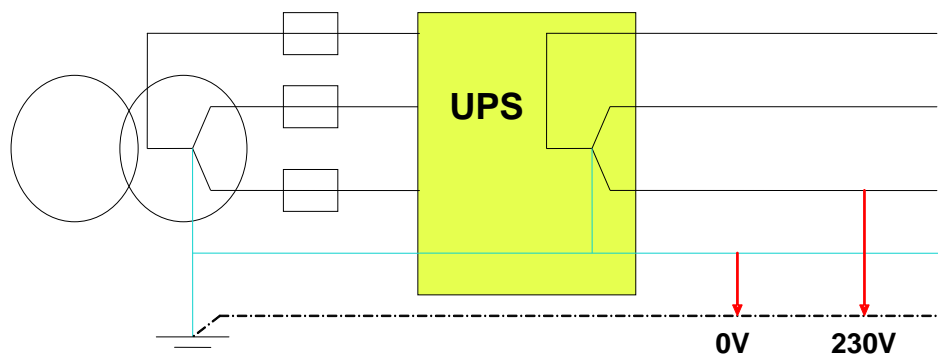

### 1.6.1 PREPARATION FOR THE INPUT CABLING



**NOTE!**

Before proceeding read the chapter [ELECTRICAL INSTALLATION](#) (SECTION 1.6) and insure before starting connecting the cable to the UPS that:

- Mains voltage (INPUT VOLTS) and frequency (FREQUENCY) correspond to the values indicated on the Nameplate of the UPS.
- Earthing is performed in accordance with the prescribed IEC Standards or with local regulations;
- UPS is connected to the mains through a Low Voltage (LV)-Distribution Board with a separate mains line (protected with a circuit breaker or fuse) for the UPS.

Provide input fuses and cables according to [Section 2, chapter 2.1.2](#) or in accordance with the prescribed IEC Standards or with the local regulations.

The input of the UPS must be fitted with circuit breakers or other kind of protection. The circuit breakers will be connected between the mains supply and the UPS and will provide additional protection to the UPS in the event of overloads and short circuits.

#### 1.6.1.1 Earthing and Connection of Mains Supply

To ensure protection of personnel during the installation of UPS make sure that the connections are performed under the following conditions:

- No mains voltage is present
  - All Loads are shut down and disconnected
  - UPS is shut down and voltage-free
  - UPS-Module is fitted in its correct position
  - Maintenance Bypass IA1 is open and in position OFF;
  - Parallel Isolators IA2-1, IA2-2, IA2-3, IA2-4, IA2-5 (depending of the UPS type) are in position OFF
  - Remove Terminal cover of the UPS
1. Connect first the Earthing wire coming from the Low Voltage-Distribution Board to the terminal "PE".
  2. Connect the input power cable coming from the Low Voltage-Distribution Board to the terminals of the UPS showed in [Section 2, chapter 2.1.2](#)
  3. Keep the phase rotation in clock-wise sense.



**NOTE!**

**INPUT NEUTRAL IS REQUIRED TO OPERATE THE RECTIFIER.**

Under the connection terminal of the UPS there is a cable-fixing rail to ensure that the cables have been fastened properly.

**NOTE:** The **UPS** is provided with facilities for both single feed (one common input cable for rectifier and bypass) and dual feed (separate input cable for rectifier and bypass).

### 1.6.1.2 Single Input Feed

To achieve correct Input Cabling see Drawing [Section 2, chapter 2.1.2](#)

For single input feed connect the mains input cable to UPS Terminal Block according to the following table:

MAINS INPUT CABLE	UPS TERMINAL
Phase L1	1L1
Phase L2	1L2
Phase L3	1L3
NEUTRAL	1N
EARTH	PE

For minimum recommended Input Cable Sections and Fuse Ratings [Section 2, chapter 2.1.2](#)

Under the connection terminal of the UPS there is a cable-fixing rail to ensure that the cables have been fastened properly.

### 1.6.1.3 Dual Input Feed

To achieve correct input cabling see Terminal Block in [Section 2, chapter 2.1.2](#)

**NOTE:** The UPS is supplied (as standard version) with facilities for a single cable feed (for rectifier and bypass).

If dual feed is required unscrew the terminal bridges between

UPS TERMINAL Rectifier		UPS TERMINAL Bypass
1L1	●	● 2L1
1L2	●	● 2L2
1L3	●	● 2L3
1N	●	● 2N
PE	●	● PE

For dual input feed connect the mains input cables to UPS Terminal according to following tables:

MAINS INPUT CABLE	UPS TERMINAL Rectifier	BYPASS INPUT CABLE	UPS TERMINAL Bypass
Phase L1	1L1	Phase L1	2L1
Phase L2	1L2	Phase L2	2L2
Phase L3	1L3	Phase L3	2L3
NEUTRAL	1N	NEUTRAL	2N
EARTH	PE	EARTH	PE

For minimum recommended Input Cable Sections and Fuse Ratings [Section 2, chapter 2.1.2](#)

Under the connection terminal of the UPS there is a cable-fixing rail to ensure that the cables have been fastened properly.

### 1.6.1.4 Preparation for the Output Cabling

Before you start connecting the loads, ensure that the sum of the indicated UPS-module rated powers (OUTPUT POWER) on the nameplates (on the front side of the UPS-modules) is equal to or larger than the total load requirements.

The output of the UPS must be fitted with circuit breakers or other kind of protection. These circuit breakers will be connected between the loads and the UPS and will provide additional protection to the UPS in the event of overloads and short circuits.

These circuit breakers will enable the protection of each load separately.

The size of the circuit breakers depends on the load rating of the load sockets.

The circuit breakers must comply with the prescribed IEC Standards. It is recommended to provide a separate output distribution board for the load.

The following values should be indicated on the output distribution board:

Maximum total load rating;

Maximum load rating of the load sockets.

If a common distribution board is used (sockets for Mains and UPS voltage), ensure that on each socket there is an indication of the applied voltage ("Mains" or "UPS").

Output power cable ratings should be in accordance with the recommended cable sections and fuses ratings or in accordance with the prescribed IEC Standards or with the local regulations.

Under the connection terminal of the UPS there is a cable-fixing rail to ensure that the cables have been fastened properly.

Ensure that the earthing is performed in accordance with the prescribed IEC Standards or with the local regulations.

#### **1.6.1.5 Connection of the Load**

To ensure protection of the personnel during the installation of the UPS make sure that the connections are performed under the following conditions:

No mains voltage is present;

All loads are shut down and disconnected;

UPS is shut down and voltage-free.

Before connecting the output power cables make sure that:

UPS-Module is fitted in its correct position;

Maintenance bypass is in position OFF;

Parallel Isolators IA2 is in position OFF

Remove the terminal cover of the UPS.

Connect the output power cable coming from the LV-Distribution Board to the terminals of the UPS as shown in drawing in Section 2 / Chapter 2.2 (Front view of the Conceptpower DPA™ S2)

### 1.6.2 Installation Checklist

- All packing materials and restraints have been removed from each cabinet.
- Each cabinet in the UPS system is placed in the installed location.
- All conduits and cables are properly routed to the UPS and auxiliary cabinets.
- All power cables are properly sized and terminated.
- A ground conductor is properly installed.
- If the cabinet does not use all module mounting locations, the provided protective covers are installed on the front and back of the cabinet.
- Battery cabinet installation instructions have been completed.
- Air conditioning equipment is installed and operating properly.
- The area around the installed UPS system is clean and dust-free. (It is recommended that the UPS be installed on a level floor suitable for computer or electronic equipment.
- Adequate workspace exists around the UPS and other cabinets.
- Adequate lighting is provided around all UPS equipment.
- Any optional accessories are mounted in their installed location and properly wired.
- Summary alarms and/or building alarms are wired appropriately. (OPTIONAL)
- Startup and operational checks performed by certified service personnel.
- All network connections are completed.

**This page left intentionally blank**

# CONTENTS SECTION-2

<b>2.1</b>	<b>BLOCK DIAGRAM</b> .....	<b>2</b>
2.1.1	WIRING AND BLOCK DIAGRAMS FOR ALL FRAMES AND MODULES.....	2
2.1.2	RECOMMENDED CABLE SECTIONS & FUSE RATINGS.....	2
2.1.2.1	Terminal connections overview.....	2
2.1.3	BLOCK DIAGRAM CONCEPTPOWER DPA.....	3
2.1.3.1	Single Feed input (Standard Version).....	3
2.1.3.2	Dual feed input (Optional Version).....	4
<b>2.2</b>	<b>FRONT VIEW</b> .....	<b>5</b>
2.2.1	FRONT VIEW OF MX FRAMES.....	5
2.2.1.1	Front View CLASSIC DPA-50 and Connection Terminals.....	5
2.2.1.2	Front View TRIPLE DPA-150 and Connection Terminals.....	7
2.2.1.3	Front View UPGRADE DPA-250 and Connection Terminals.....	9
<b>2.3</b>	<b>BATTERY CONNECTIONS</b> .....	<b>11</b>
2.3.1	INTERNAL BATTERY MODULES.....	11
2.3.1.1	Internal Battery Modules CLASSIC DPA-50.....	11
2.3.1.2	Internal Battery Modules TRIPLE DPA-150.....	12
2.3.2	EXTERNAL BATTERY CABINET AND BATTERY CONNECTION.....	13
2.3.2.1	External Battery Configuration.....	13
2.3.2.2	Connection of External Battery Cabinet for Conceptpower DPA™ S2.....	15
2.3.2.3	Connection of External Separate Battery for Conceptpower DPA™ S2.....	16
2.3.2.4	Connection of External Common Battery for Conceptpower DPA™ S2.....	16

## 2.1 BLOCK DIAGRAM

### 2.1.1 WIRING AND BLOCK DIAGRAMS FOR ALL FRAMES AND MODULES

The customer has to supply the wiring to connect the UPS to the local power source. The installation inspection and initial start up of the UPS and extra battery cabinet must be carried out by a qualified service personnel such as a licensed service engineer from the manufacturer or from an agent certified by the manufacturer.

### 2.1.2 RECOMMENDED CABLE SECTIONS & FUSE RATINGS

#### 2.1.2.1 Terminal connections overview

FRAME TYPE Terminals (T) Connection Bar (B)	Separate. Battery (+ / N / -) +PE	Common Battery (+ / N / -) +PE	Input Bypass 3+N	Input Rectifier 3+N+PE	Output load 3+N+PE
<b>CLASSIC DPA-50</b>	3+1 x 16/25mm <sup>2</sup> (T)	3+1 x 16/25mm <sup>2</sup> (T)	4 x 16/25mm <sup>2</sup> (T)	5 x 16/25mm <sup>2</sup> (T)	5 x 16/25mm <sup>2</sup> (T)
<b>TRIPLE DPA-150</b>	9+1 x 16/25mm <sup>2</sup> (T) +PE 1xM10 (B)	3 x M10 (B) +PE 1xM10 (B)	3 x M10(B) +PE 1xM10 (B)	4 x M10 (B) +PE 1xM10 (B)	4 x M10 (B) +PE 1xM10 (B)
<b>UPGRADE DPA-250</b>	15 x 16/25mm <sup>2</sup> (T) +PE 1xM12 (B)	3 x M12 (B) +PE 1xM12 (B)	3 x M12 (B) +PE 1xM12 (B)	4 x M12 (B) +PE 1xM12 (B)	4 x M12 (B) +PE 1xM12 (B)

**CLASSIC DPA-50**

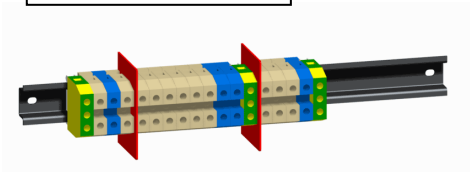

**TRIPLE DPA-150**



**UPGRADE DPA-250**

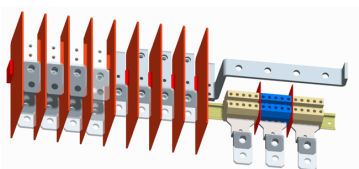

**Dual feed input**

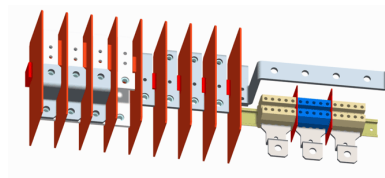

**Single feed input**



### 2.1.3 BLOCK DIAGRAM CONCEPTPOWER DPA

#### 2.1.3.1 Single Feed input (Standard Version)

Cable Sections and Fuse Ratings recommended. Alternatively, local standards to be respected

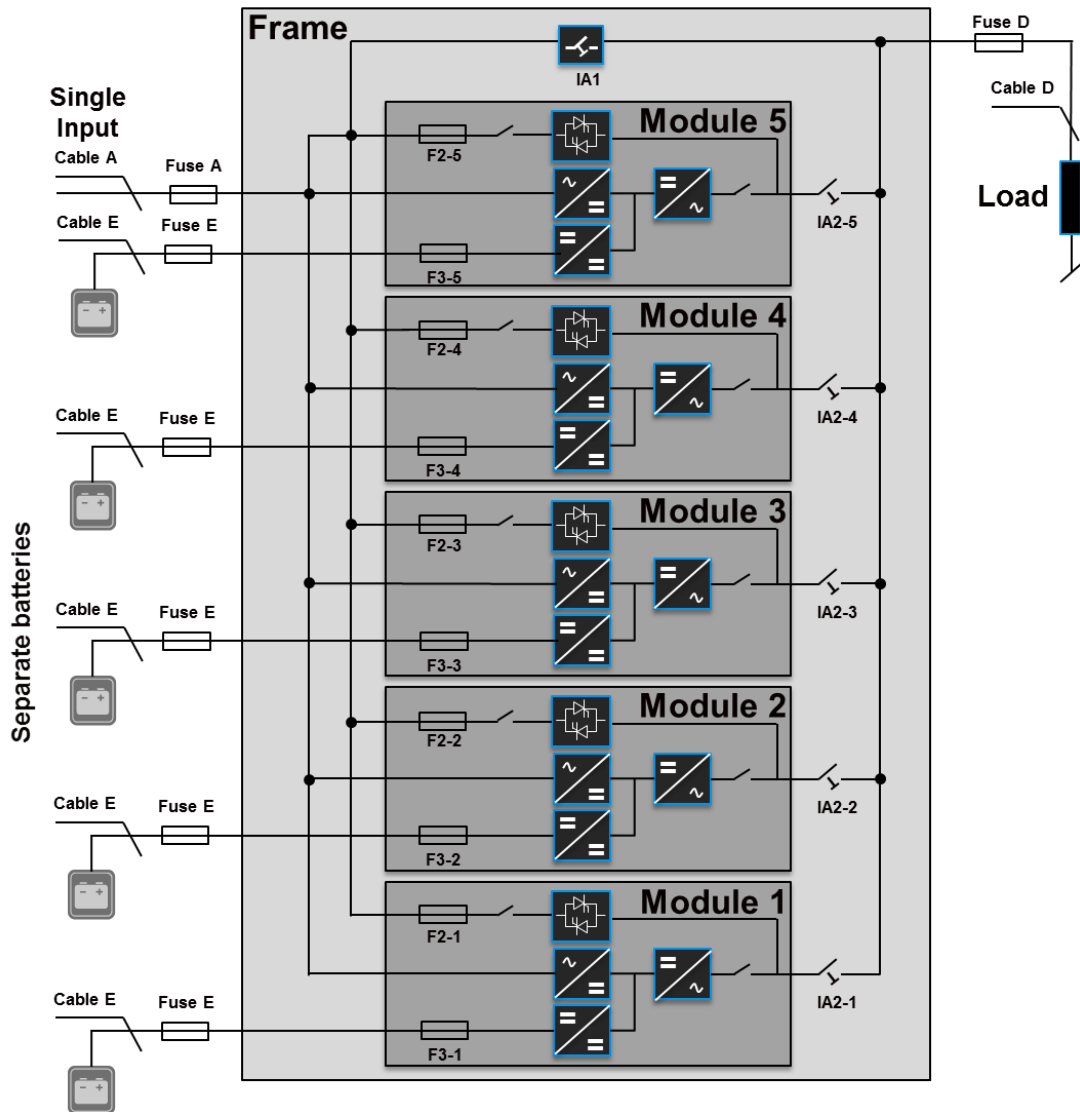

Frame type	Load kVA cosphi 0.8	Input 3x400V			Output 3x400V cosphi 0.8			Battery	
		Fuse A (Agl/CB)	Cable A (mm <sup>2</sup> ) (IEC 60950-1)	Max. Input Current with battery charging (A)	Cable D (mm <sup>2</sup> ) (IEC 60950-1)	I <sub>nom</sub> (A)	Fuse E + / N / - (Agl/CB)	Com. Battery	Sep. Battery
<b>MX Frames (Frames shall be cabled to there full rating capability)</b>									
CLASSIC DPA 50	50	3x100A	5x25	67	5x25	72 A	3x100A*1	3x25	3x25
TRIPLE DPA-150	150	3x250A	5x120 or 5x(2x50)	202	5x120 or 5x(2x50)	218 A	3x300A*1	3x150	3x (3x25)
UPGRADE DPA-250	250	3x400A	5x(2x95)	337	5x(2x95)	362 A	3x500A*1	3x(2x150)	5x (3x25)

\*1 only valid for common battery use

2.1.3.2 Dual feed input (Optional Version)

Cable Sections and Fuse Ratings recommended. Alternatively, local standards to be respected

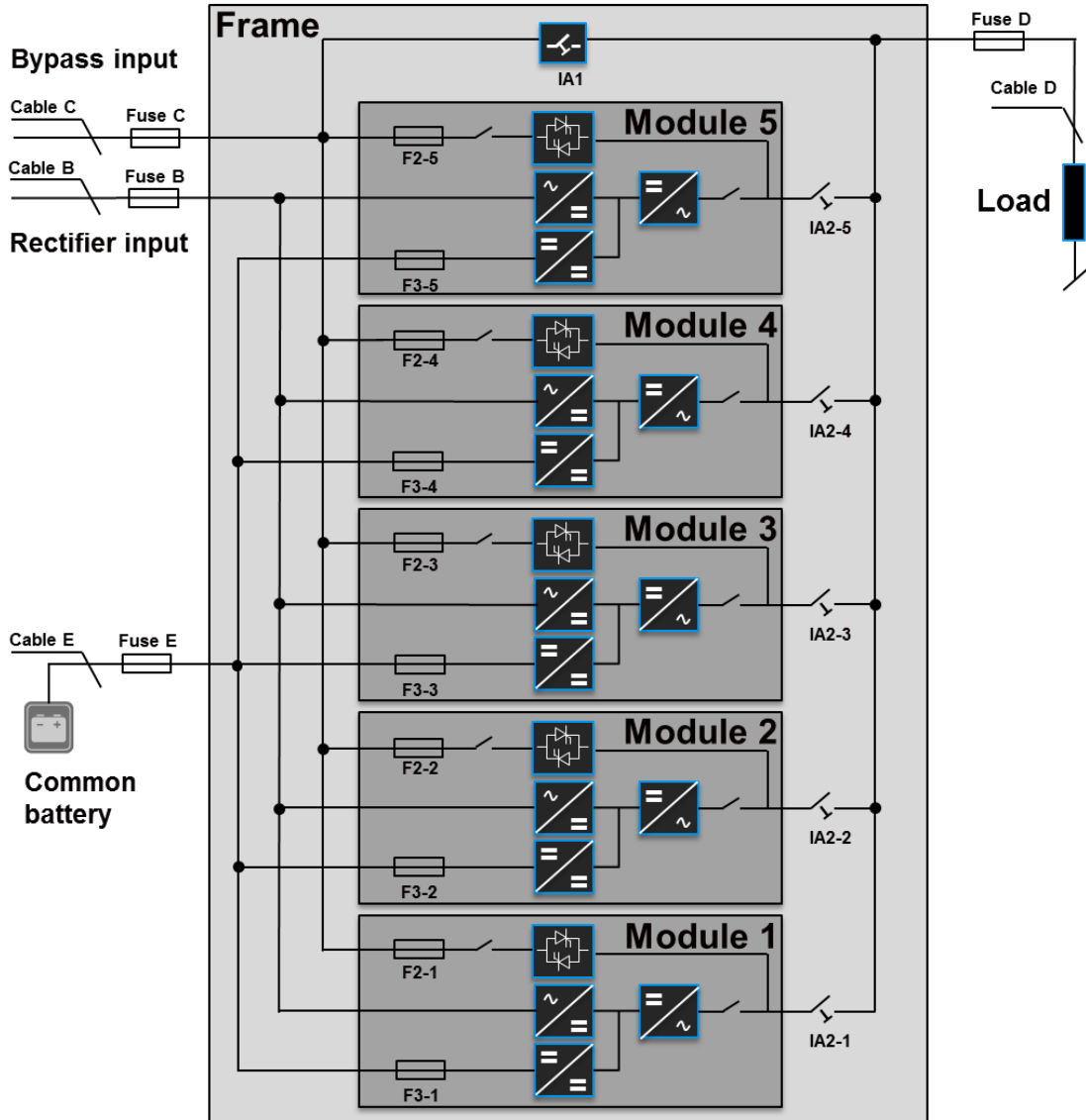

Frame type	Load kVA cosphi 0.8	Input 3x400V			Bypass 3x400V		Output 3x400V cosphi 0.8		Battery		
		Fuse B (Agl/CB)	Cable B (mm <sup>2</sup> ) (IEC 60950-1)	Max. Input Current with battery charging (A)	Fuse C (Agl/CB)	Cable C (mm <sup>2</sup> ) (IEC 60950-1)	Cable D (mm <sup>2</sup> ) (IEC 60950-1)	I nom	Fuse E +/-N/- (Agl/CB)	Cable E (mm <sup>2</sup> ) for CBAT DPA 120 or 200 ONLY + / N / -	
										Com. Battery	Sep. Battery
<b>MX Frames (Frames shall be cabled to there full rating capability)</b>											
CLASSIC DPA 50	50	3x100A	5x25	67	3x100A	4x25	5x25	72 A	3x100A*1	3x25	3x25
TRIPLE DPA-150	150	3x250A	5x120 or 5x(2x50)	202	3x250A	4x120 or 4x(2x50)	5x120 or 5x(2x50)	218 A	3x300A*1	3x150	3x(3x25)
UPGRADE DPA-250	250	3x400A	5x(2x95)	337	3x400A	4x(2x95)	5x(2x95)	362 A	3x500A*1	3x(2x150)	5x(3x25)

\*1 only valid for common battery use

**2.2 FRONT VIEW**

**2.2.1 FRONT VIEW OF MX FRAMES**

**2.2.1.1 Front View CLASSIC DPA-50 and Connection Terminals**

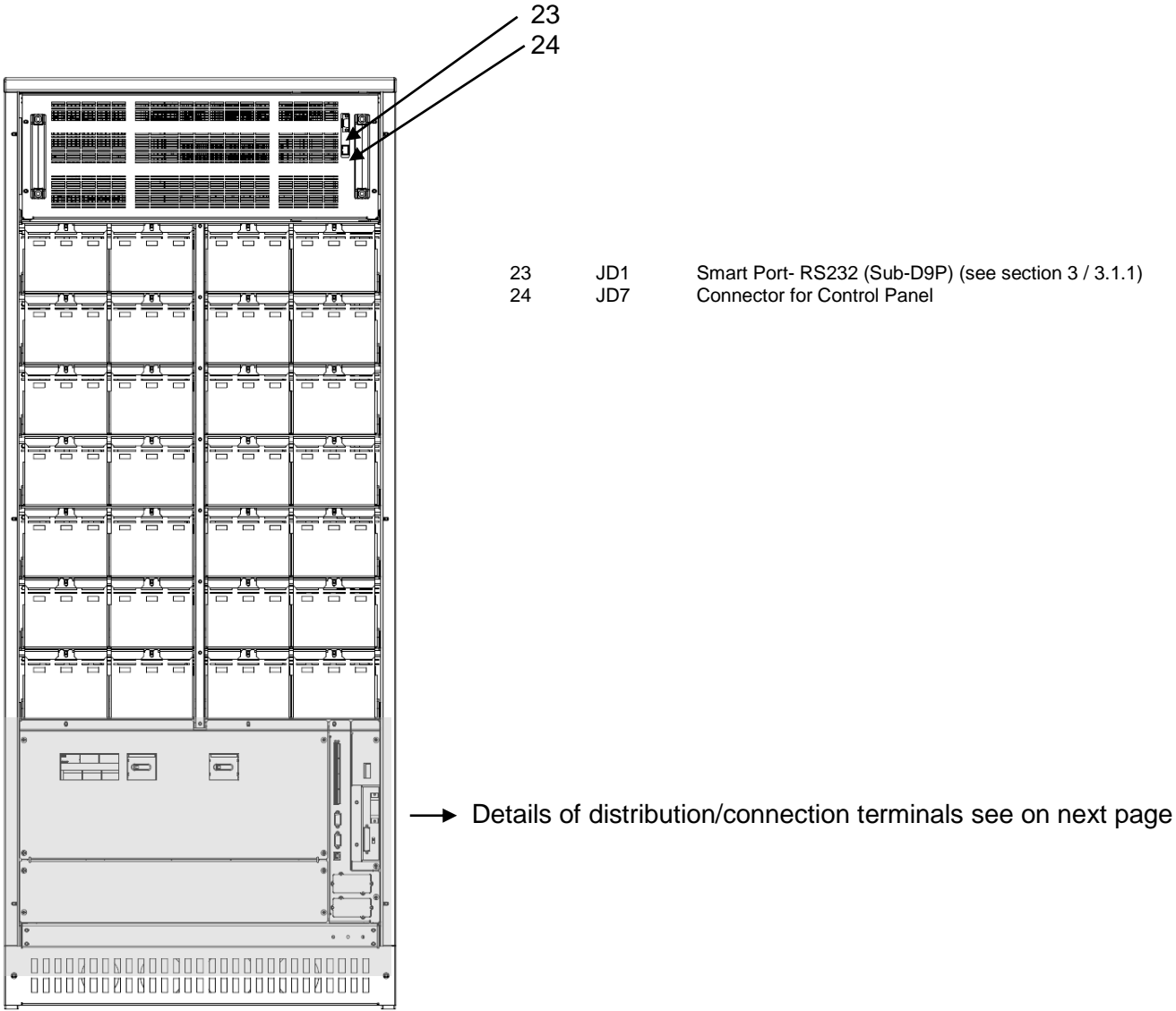

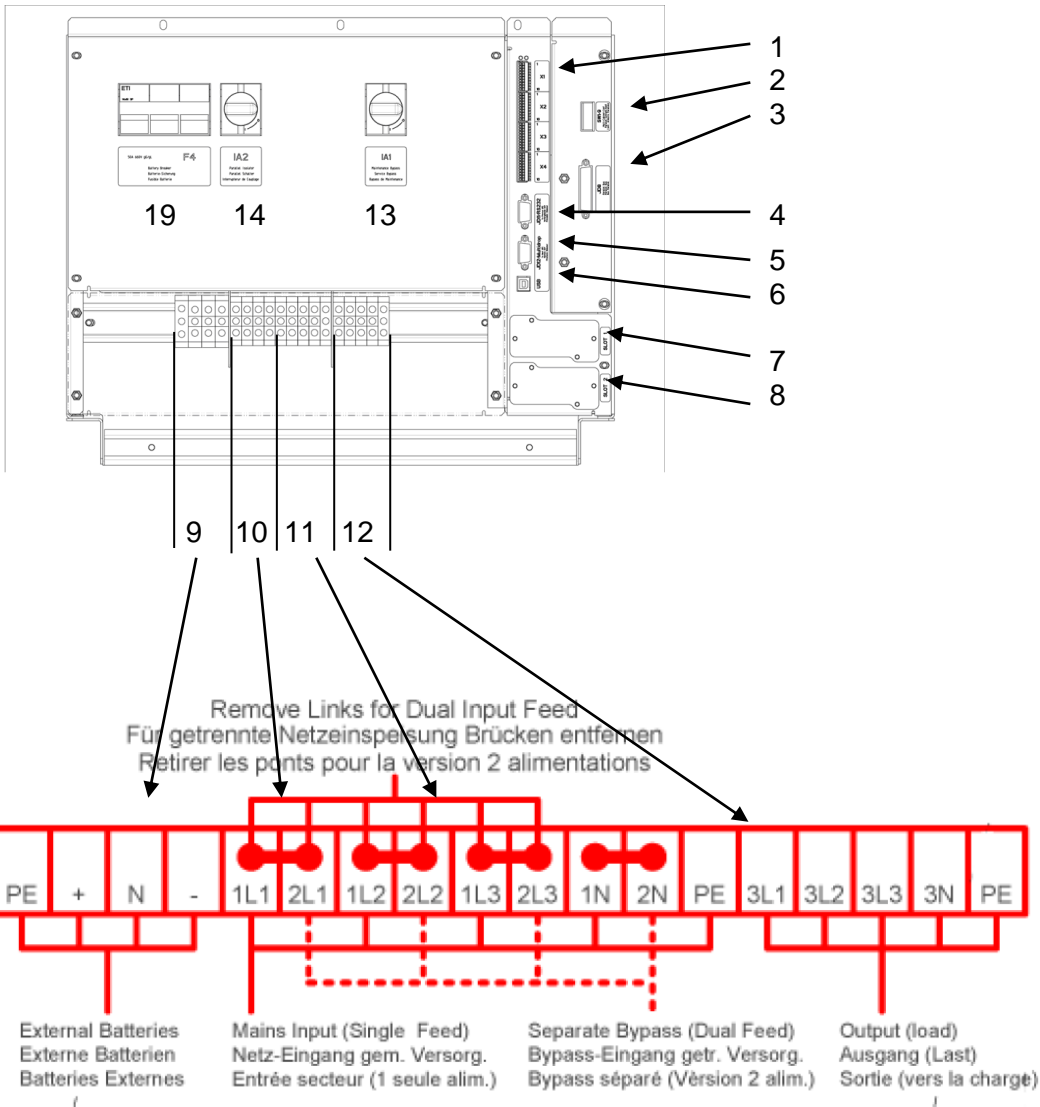

- 1 X1-X4 Customer interface on Phoenix Terminals:  
X1 Customer Inputs  
X2...X4 = Potential free contacts (detail see Section 3 / 3.1.2 )
- 2 SW1-9 Multi-Cabinet Configuration Switch (see section 4)
- 3 JD8 Parallel BUS connector  
**ONLY For paralleling cabinets use optional adapter:**  
**JD5 Parallel BUS - Input Connector**  
**JD6 Parallel BUS - Output Connector**
- 4 JD11 RS232 / Sub D9/ female, PC interface
- 5 JD12 RS232/ Sub D9 / male for Multidrop ONLY
- 6 USB PC Interface
- 7 SNMP Slot for optional SNMP card ONLY
- 8 Modem Slot for optional Modem/Ethernet card ONLY
- 9 Battery terminal + / N / - 16/25 mm<sup>2</sup>
- 10 Input Bypass terminal for Dual Input feed 16/25 mm<sup>2</sup>
- 11 Input Rectifier terminal for Single feed 16/25 mm<sup>2</sup>
- 12 Output Load terminal 16/25 mm<sup>2</sup>
- 13 IA1 Maintenance Bypass
- 14-(18) IA2-1 Parallel Isolator UPS-Module 1
- 19-(21) F4 Battery Fuse Holder Module 1 14x51/ 50A Fast Acting

2.2.1.2 Front View TRIPLE DPA-150 and Connection Terminals

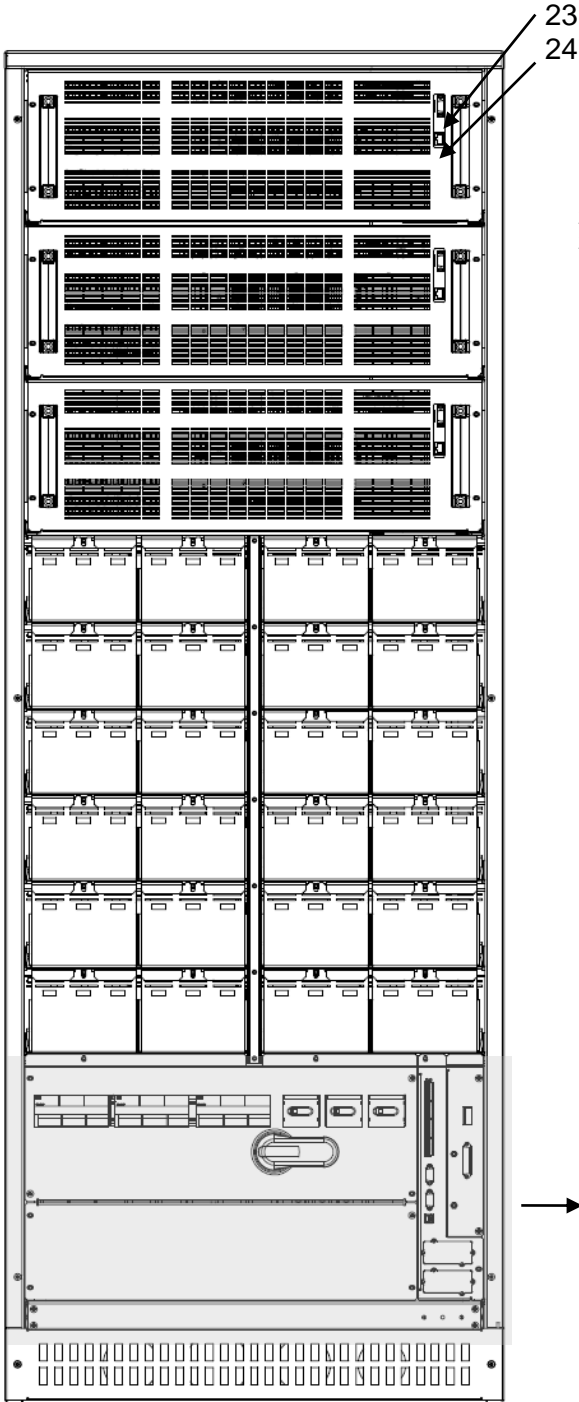

23	JD1	Smart Port- RS232 (Sub-D9P) (see section 3 / 3.1.1)
24	JD7	Connector for Control Panel

→ Details of distribution/connection terminals see on next page

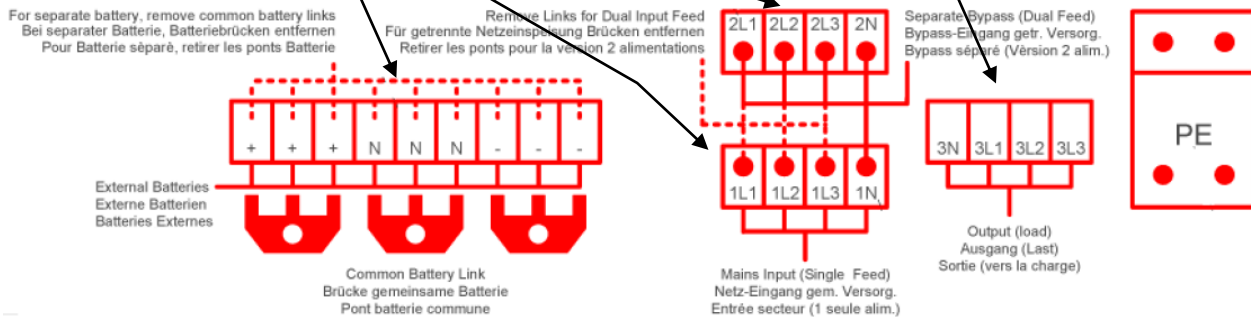
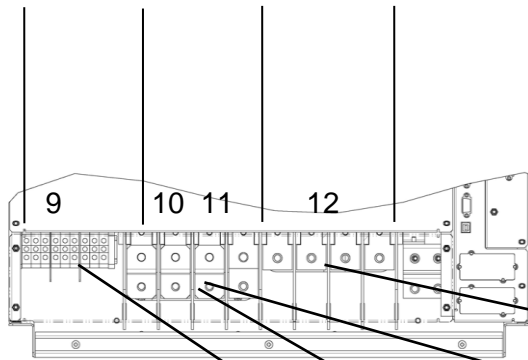
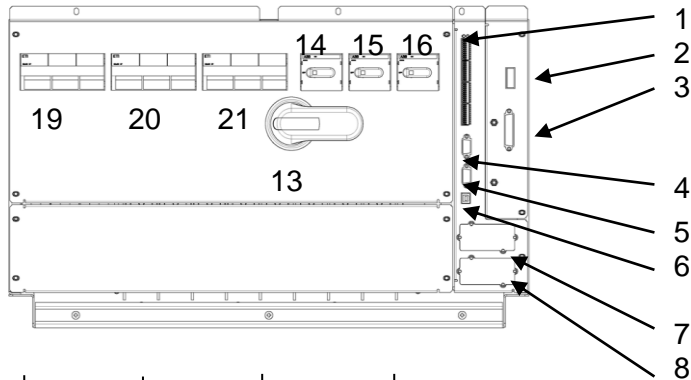

- 1 X1-X4 Customer interface on Phoenix Terminals:  
X1 Customer Inputs  
X2...X4 = Potential free contacts (detail see Section 3 / 3.1.2 )
- 2 SW1-9 Multi-Cabinet Configuration Switch (see section 4)
- 3 JD8 Parallel BUS connector  
**ONLY For paralleling cabinets use optional adapter:**  
**JD5 Parallel BUS - Input Connector**  
**JD6 Parallel BUS - Output Connector**
- 4 JD11 RS232 / Sub D9/ female, PC interface
- 5 JD12 RS232/ Sub D9 / male for Multidrop ONLY
- 6 USB PC Interface
- 7 SNMP Slot for optional SNMP card ONLY
- 8 Modem Slot for optional Modem/Ethernet card ONLY
- 9 Battery terminal + / N / - for separate bat. 16/25 mm<sup>2</sup>
- 9\* 3 Battery terminal for common battery M10 + PE 1x M10
- 10 Input Bypass terminal for Dual Input feed 3xM10
- 11 Input Rectifier terminal for Single feed 4xM10
- 12 Output Load terminal 4xM10
- 13 IA1 Maintenance Bypass
- 14 IA2-1 Parallel Isolator UPS-Module 1
- 15 IA2-2 Parallel Isolator UPS-Module 2
- 16 IA2-3 Parallel Isolator UPS-Module 3
- 19 F4 Battery Fuse Holder Module 1 14x51/ 50A Fast Acting
- 20 F5 Battery Fuse Holder Module 2 14x51/ 50A Fast Acting
- 21 F5 Battery Fuse Holder Module 3 14x51/ 50A Fast Acting

2.2.1.3 Front View UPGRADE DPA-250 and Connection Terminals

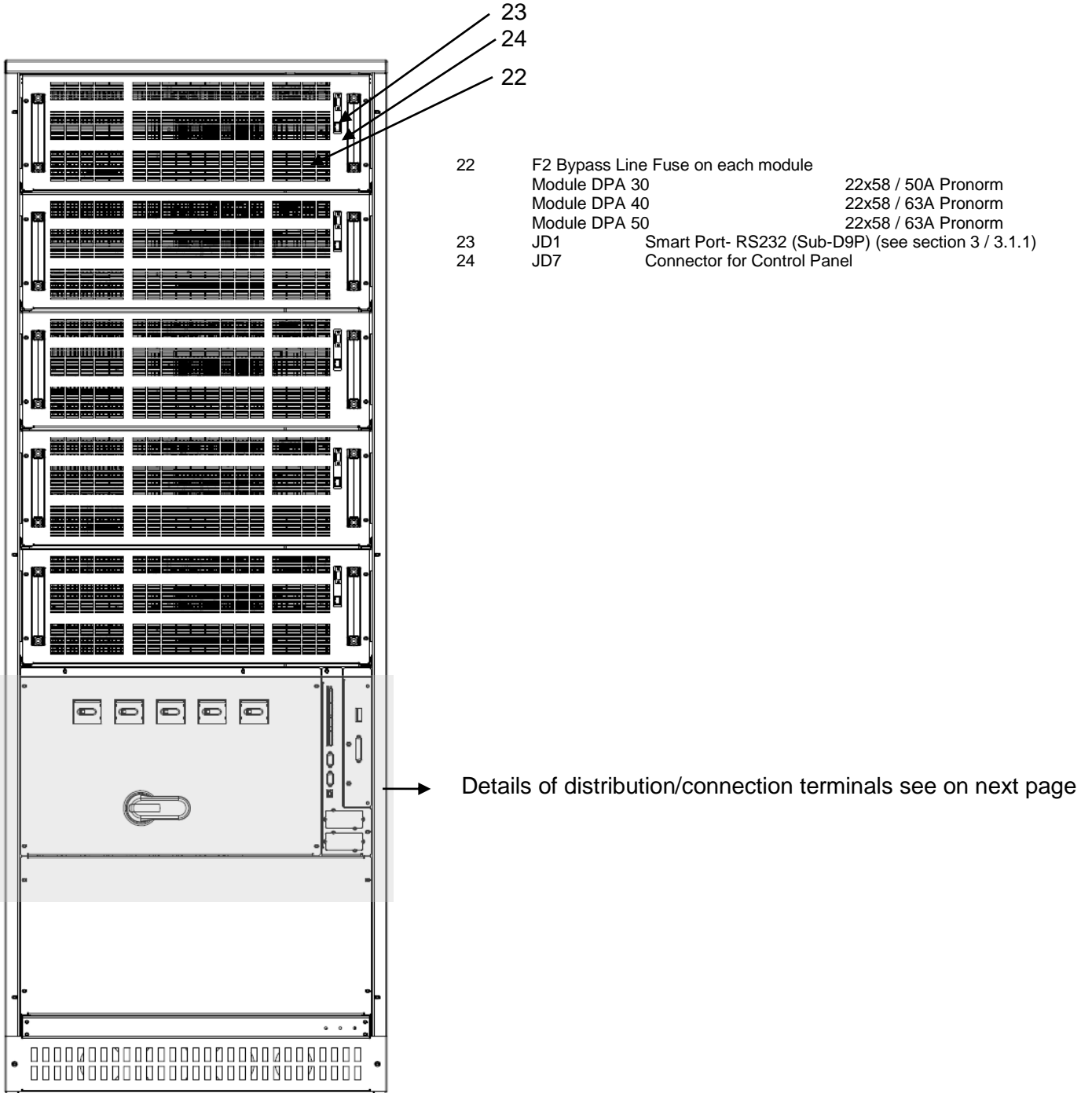

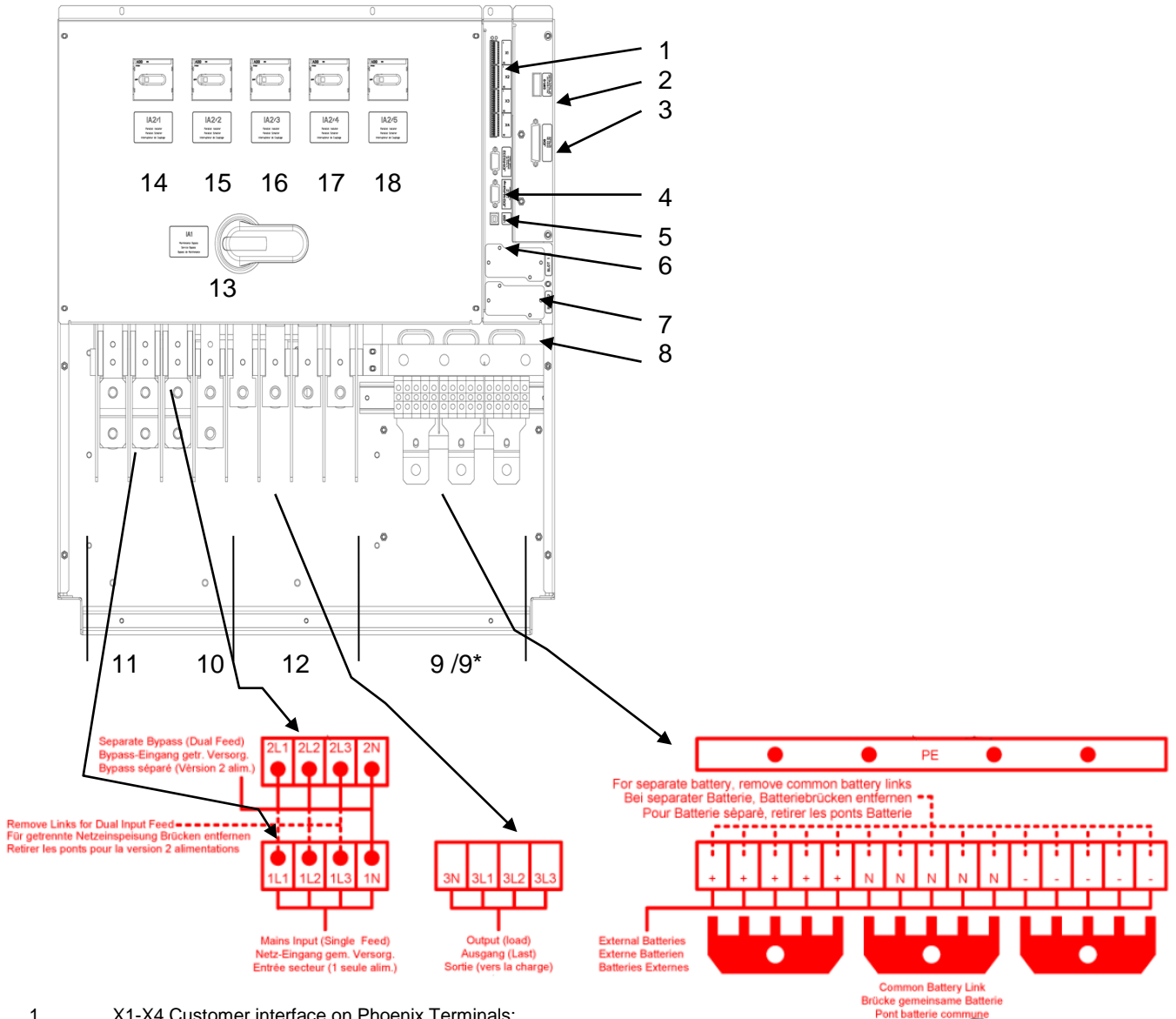

- 1 X1-X4 Customer interface on Phoenix Terminals:  
X1 Customer Inputs  
X2...X4 = Potential free contacts  
(detail see Section 3 / 3.1.2 )
- 2 SW1-9 Multi-Cabinet Configuration Switch ( see section 4)
- 3 JD8 Parallel BUS connector  
**ONLY For paralleling cabinets use optional adapter:**  
**JD5 Parallel BUS - Input Connector**  
**JD6 Parallel BUS - Output Connector**
- 4 JD11 RS232 / Sub D9/ female, PC interface
- 5 JD12 RS232/ Sub D9 / male for Multidrop ONLY
- 6 USB PC Interface
- 7 SNMP Slot for optional SNMP card ONLY
- 8 Modem Slot for optional Modem/Ethernet card ONLY
- 9 15 Battery terminal + / N / - for separate bat. 16/25 mm2
- 9\* 3 Battery terminal for common battery for M12 + PE 1x M12
- 10 Input Bypass terminal for Dual Input feed 3xM12
- 11 Input Rectifier terminal for Single feed 4xM12
- 12 Output Load terminal 4xM12
- 13 IA1 Maintenance Bypass
- 14 IA2-1 Parallel Isolator UPS-Module 1
- 15 IA2-2 Parallel Isolator UPS-Module 2
- 16 IA2-3 Parallel Isolator UPS-Module 3
- 17 IA2-4 Parallel Isolator UPS-Module 4
- 18 IA2-5 Parallel Isolator UPS-Module 5



**2.3 BATTERY CONNECTIONS**

**2.3.1 INTERNAL BATTERY MODULES**

**2.3.1.1 Internal Battery Modules CLASSIC DPA-50**

In **Conceptpower DPA™ S2 CLASSIC DPA-50 FRAME** there is space for up to 280 x 9Ah internal batteries. In the drawing below different Battery and System configurations are shown. The batteries may be used as separate batches for each UPS-Module or they can be used as common batteries for all tree UPS-Modules.

**NOTE:** For UPS-Systems DPA 30kVA and DPA 50kVA it is allowed to use 42-50 (only even numbers) of 12V-battery blocks.

**NOTE:** Set-up the correct number of battery blocks on Control Panel (Menu: Service-Set-Up).

**CONCEPTPOWER CLASSIC DPA-50**

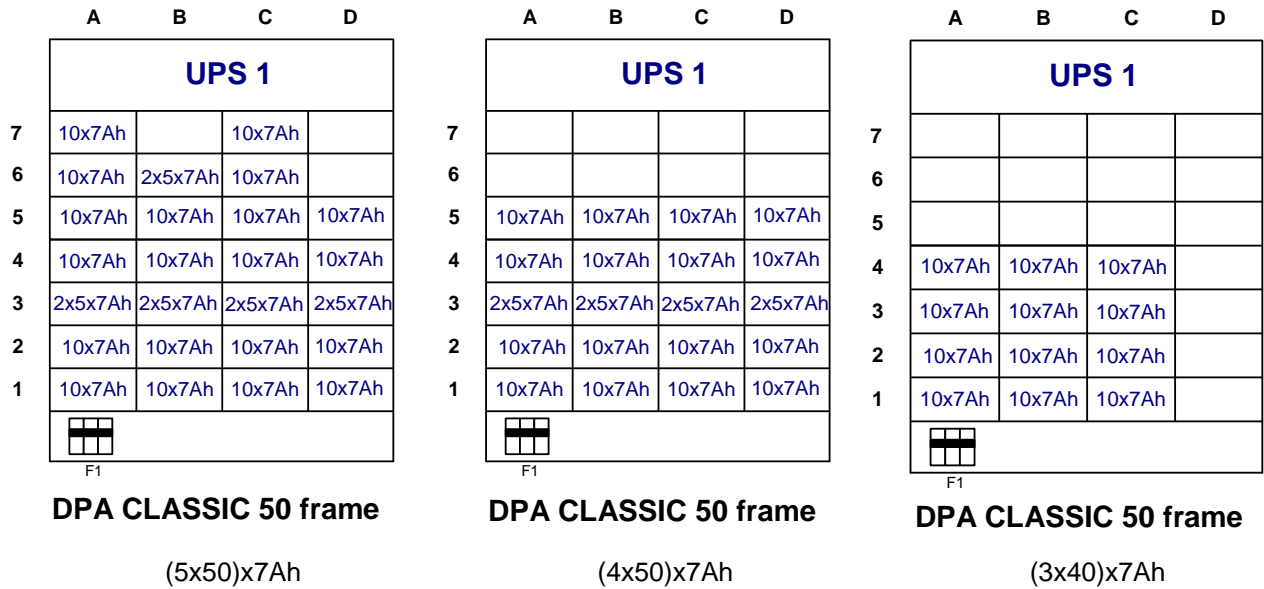

Other combination possible : refer to Section 10

**2.3.1.2 Internal Battery Modules TRIPLE DPA-150**

In **Conceptpower DPA™ S2 CLASSIC DPA-50 FRAME** there is space for up to 240 x 9Ah internal batteries. In the drawing below different Battery and System configurations are shown. The batteries may be used as separate batches for each UPS-Module or they can be used as common batteries for all tree UPS-Modules.

**NOTE:** For UPS-Systems DPA 30kVA and DPA 50kVA it is allowed to use 42-50 (only even numbers) of 12V-battery blocks.

**NOTE:** Set-up the correct number of battery blocks on Control Panel (Menu: Service-Set-Up).

**CONCEPTPOWER TRIPLE DPA-150**

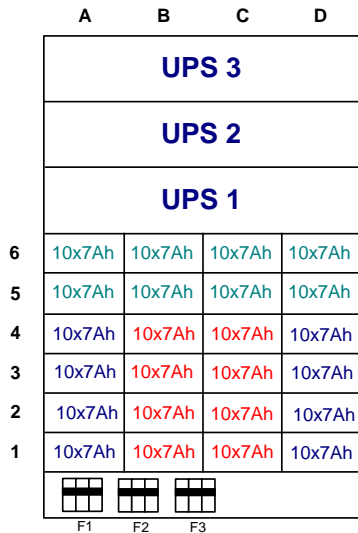

**DPA TRIPLE 150 frame**  
3x(2x40)x7Ah

Other combination possible : refer to Section 10

## 2.3.2 EXTERNAL BATTERY CABINET AND BATTERY CONNECTION



**WARNING!**

KEEP OUT OF BATTERY POLES WHICH CONTAIN DANGEROUS DC-VOLTAGES CAUSING FATAL ACCIDENTS. NOTE: MANIPULATION ON THE BATTERY SYSTEM SHOULD ONLY BE DONE BY TRAINED SERVICE AND MAINTENANCE PERSONEL OF THE MANUFACTURER OR HIS CERTIFIED SERVICE PARTNERS. INAPPROPRIATE MANIPULATIONS OF THE BATTERIES CAN CAUSE LIGHTNING SPARKS. WHILE OPERATING ON BATTERY SYSTEMS IT IS MANDATORY TO WEAR GLASSES.

### 2.3.2.1 External Battery Configuration

In the UPS-cabinet of the **Conceptpower DPA™ S2 UPGRADE DPA 250** there is no space provided for batteries.

There are 2 external matching battery cabinets available:

- CBAT DPA-120 for Separate or Common battery configurations of 24Ah or 28Ah blocks (max. 120 Blocks)
- CBAT DPA-200 for Separate or Common battery configurations for 24Ah or 28Ah blocks (max. 200 Blocks)

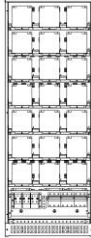
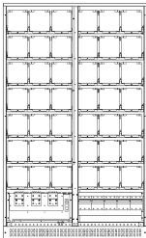
S-type = For Separate. Battery C-type = For Common. Battery		<b>CBAT-DPA-120</b> S-type or C-type	<b>CBAT-DPA-200</b> S-type or C-type
<b>BATTERY FRAMES</b>			
Configuration accommodates:	<b>Max.</b>	<b>120 Batt. block x 24Ah/28Ah on 8 shelf 3x5=15 blocks/shelf</b>	<b>200 Batt. blocks x 24Ah/28Ah on 7 shelf 6x5=30 blocks/shelf</b>
Battery fuses / Max. Batt. Strings : Terminals :	<b>S-type</b>	<b>3 / 3 (Terminal 9 x 16/25mm<sup>2</sup>)</b>	<b>5 / 5 (Terminal 15 x 16/25mm<sup>2</sup>)</b>
Battery fuses / Max. Batt. Strings Terminals :	<b>C-type</b>	<b>3 / 3 + Com. Connection Bar 3 x (2xM8) +PE 2xM8</b>	<b>5 / 5 + Com. Connection Bar 3 x (2xM10) +PE 2xM10</b>
Fuse Type (Very Fast acting)	<b>A</b>	<b>3x100 A</b>	<b>5x100A</b>
Dimensions (WxHxD)	<b>mm</b>	<b>730x1975x800</b>	<b>1200x1975x800</b>
Weight with trays and w/o batteries	<b>kg</b>	<b>290</b>	<b>410</b>

For detailed information and layout of the battery cabinets please refer to section 10 / Options

**NOTE:**

For UPS-Modules DPA 30kVA, 40kVA and 50kVA use only 42-50 (only even numbers) of 12V-battery blocks.

**NOTE:** Set-up the correct number of battery blocks on Control Panel (Menu: Service-Set-Up)

Frame: Upgrade DPA 250 with Modules DPA 30 S2 or DPA 50 S2

CBAT DPA-120



**Battery Cabinet 120**

(3x40)x28Ah

CBAT DPA-200

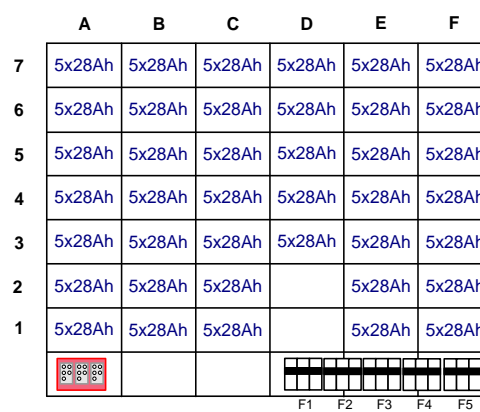

**Battery Cabinet 200**

(5x40)x28Ah

		CBAT DPA-120	CBAT DPA-200
Dimensions (WxHxD)	mm	730x1975x800	1200x1975x800
Weight with trays and w/o batteries	kg	290	410

For detailed information and layout of the battery cabinets please refer to section 10

Examples:

On drawing CBAT DPA-120 (3x40)x28Ah battery blocks are fitted. The “A” column of 40x28Ah belongs to UPS-1, the “B” column of 40x28Ah belongs to UPS-2 and the “C” column of 40x28Ah belongs to UPS-3.

On drawing CBAT DPA-200 (5x40)x28Ah battery blocks are fitted in the battery cabinet and each UPS-Module is provided with 40x28Ah.

Depending on the request the batteries may be connected separately for each Module or it is possible to parallel them together into one common battery for five UPS-modules.

### 2.3.2.2 Connection of External Battery Cabinet for Conceptpower DPA™ S2

It is normally recommended for redundant Multi-Module systems to provide each UPS-Module with its own separate battery. In this way the redundancy is extended also to the batteries. In the Figure 1. and Figure 2. the drawing shows how to connect the batteries in the external battery cabinet and the Upgrade DPA frames.



**ALL THE OPERATIONS IN THIS MANUAL MUST BE PERFORMED BY CERTIFIED ELECTRICIANS OR BY QUALIFIED INTERNAL PERSONNEL. DO NOT OPERATE IN CASE OF PRESENCE OF WATER OR MOISTURE. BY OPENING OR REMOVING THE UPS-COVERS YOU RUN RISK OF EXPOSURE TO DANGEROUS VOLTAGES!**

If the five battery batches are desired to be used as one common battery for all five UPS-Modules then Battery Links may be connected as shown below.



To ensure protection of the personnel during the installation of the UPS make sure that the connections are performed under the following conditions:

- No mains voltage is present in the UPS
- All the loads are disconnected
- The UPS and the external battery are voltage-free

To verify the complete shut down of the **Conceptpower DPA™ S2** perform following steps:

- 1) Make sure that the fuses feeding the UPS in the input Distribution Board are all open and no power is fed to the UPS.
- 2) Make sure the "MAINTENANCE BYPASS"(IA1) is open (position "OFF")
- 3) Make sure the battery fuses in the external battery cabinet and on the UPS are open.
- 4) Connect Earth (**PE**) between the UPS and external battery cabinet.
- 5) Connect the corresponding **+** , **N**, - terminals between UPS and external battery cabinet according to drawing

**2.3.2.3 Connection of External Separate Battery for Conceptpower DPA™ S2**

External Battery Cabinet DPA for separate Batteries per Module

Frame : UPGRADE DPA

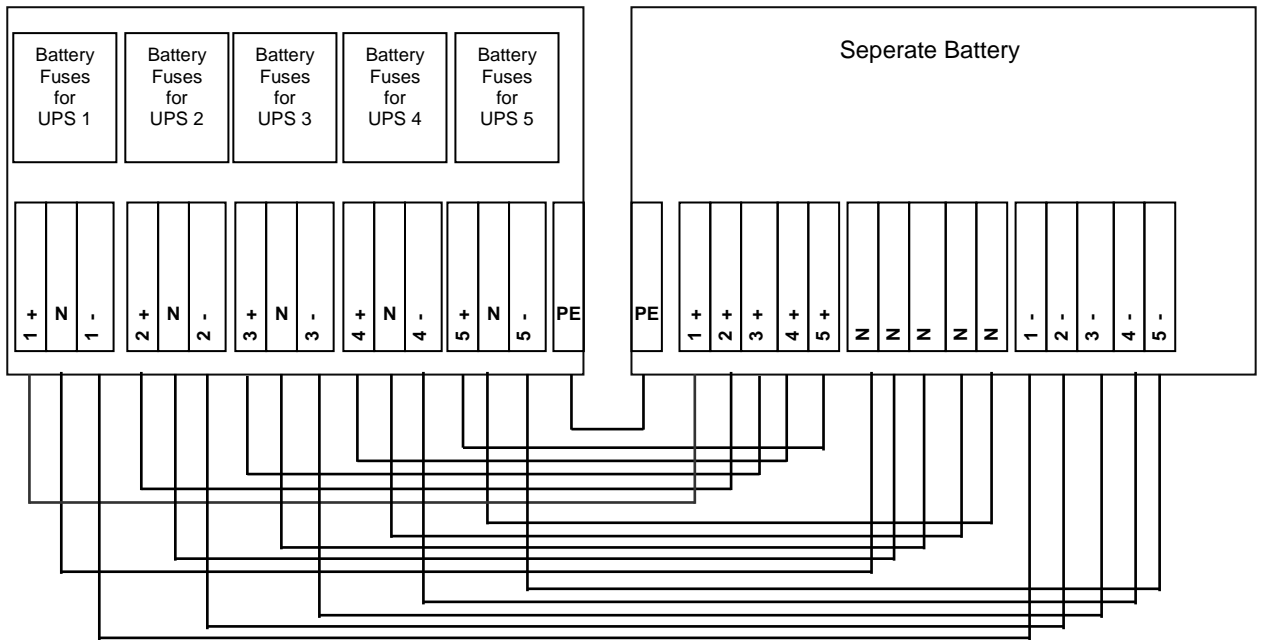

Fig. 1. Connection of external separate batteries

**2.3.2.4 Connection of External Common Battery for Conceptpower DPA™ S2**

External Battery Cabinet DPA for common Batteries

Frame : UPGRADE DPA

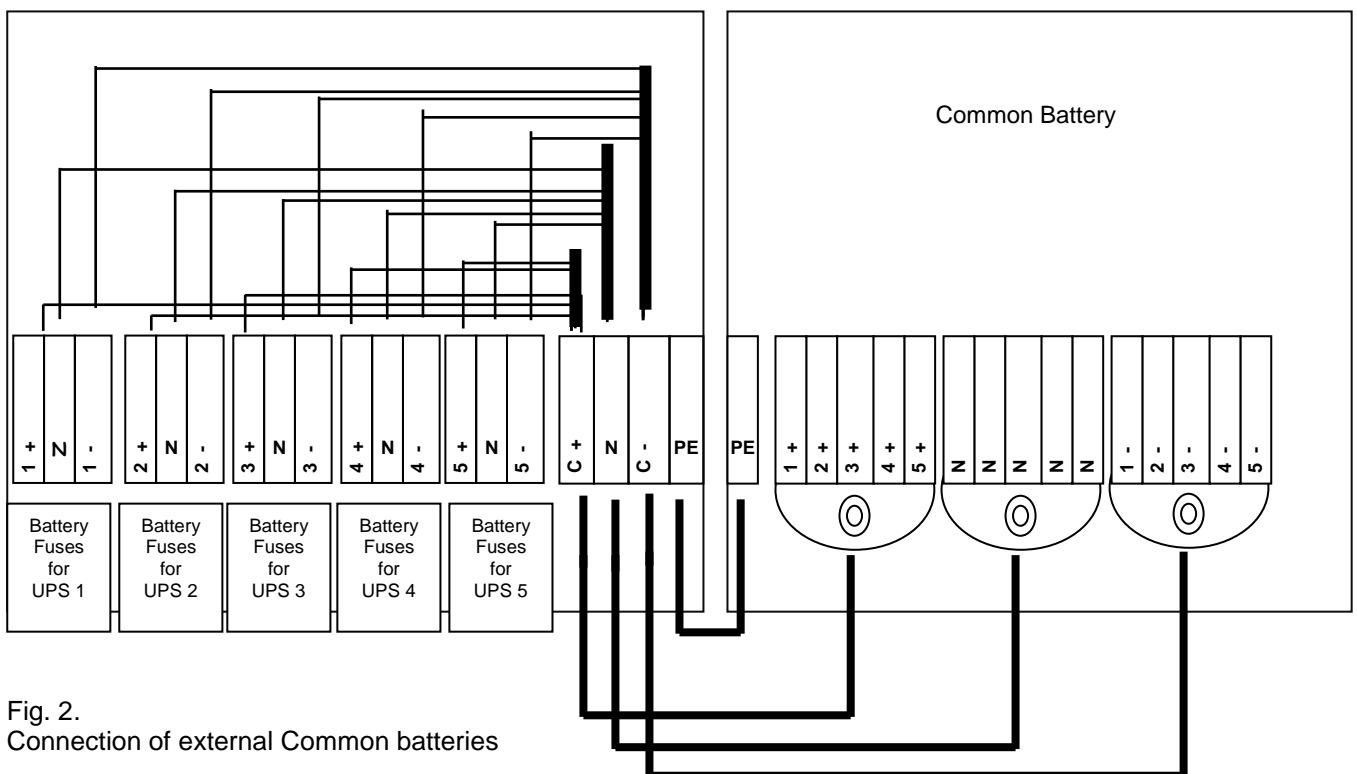

Fig. 2. Connection of external Common batteries

# CONTENTS SECTION-3

<b>3.1</b>	<b>INTERFACING .....</b>	<b>2</b>
3.1.1	SMART PORT JD1 on each module (Serial RS 232 / Sub D9 / male) .....	2
3.1.2	Customer interface and DRY PORTs (volt-free contacts) .....	3
3.1.2.1	Input Interfaces Terminal block X1 .....	3
3.1.2.2	Output Interfaces Terminal blocks X2, X3, X4 (DRY PORTs) .....	3
3.1.3	JD11 / RS232 Computer Interface .....	4
3.1.4	JD12 / RS232 Interface for Multidrop .....	4
3.1.5	USB/2 Computer Interface .....	4

### 3.1 INTERFACING

Each UPS cabinet is provided with communication port on each single module and a communication card, which provides system information

On the Module :

- JD1 / RS232 Sub D9 / male: SMART PORT Interface (one per Module)

Communication card (next to the distribution) :

- Input Interfaces X1 (Phoenix terminals)
- Output Interfaces : X2, X3, X4 DRY PORTs ,volt-free contacts (Phoenix terminals)
- JD11 / RS232 Sub D9 / female : Interface (UPS system to computer)
- JD12 / RS232 Sub D9 / male Interface for Multidrop connection between several UPS cabinets
- USB Interface (UPS system to computer)

#### 3.1.1 SMART PORT JD1 on each module (Serial RS 232 / Sub D9 / male)

The **SMART PORT JD1** located on the Modules itself is an intelligent RS 232 serial port that allows the UPS Module to be connected to a computer. The connector is a standard D-Type, 9-pin, male.

When installed the optional SMART PORT, the software WAVEMON allows the computer to monitor the mains voltage and the UPS status continuously.

In the event of any changes the computer terminal will display a message.  
(For details see our Monitoring Package: **WAVEMON** ).

The fig. 1. shows how to connect a PC to the UPS with different Sub-D connectors.

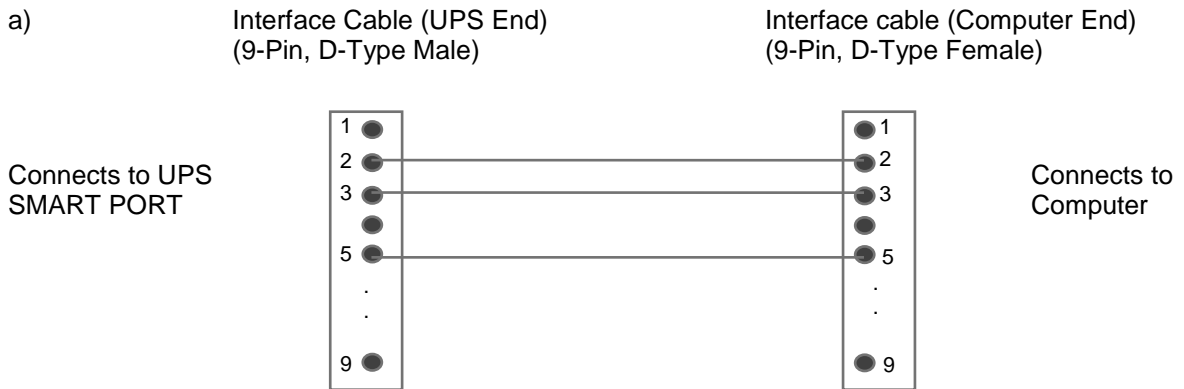

Figure 1. Connector Cable - PC Serial Port with 9-Pin Connection



### 3.1.2 Customer interface and DRY PORTs (volt-free contacts)

All the Input and Output interfaces are connected to Phoenix terminals (cable 0.5 mm2)

#### 3.1.2.1 Input Interfaces → Terminal block X1

- Connection of Remote Shut down facilities, Generator Operation, Customers specials (see Section 9, chapter 1.2 OPTIONS)

#### 3.1.2.2 Output Interfaces → Terminal blocks X2, X3, X4 (DRY PORTs)

- Provision of signals for the automatic and orderly shutdown of servers, AS400 or Automation building systems

All voltage free contacts are rated 60 VAC max. and 500 mA max.:

Block	Terminal	Contact	Signal	On Display	Function
X1	X1 / 1		+ 3.3 Vdc		<b>Remote Shut down</b>
	X1 / 2		GND		(Do not remove the factory mounted bridge until external Remote Shut down is connected)
	X1 / 3		+ 3.3 Vdc		<b>Generator Operation</b>
	X1 / 4		GND		(NC = Generator ON)
	X1 / 5		+ 3.3 Vdc		<b>Customer IN 1</b>
	X1 / 6		GND		(Function on request, to be defined)
	X1 / 7		+ 3.3 Vdc		<b>Customer IN 2</b>
	X1 / 8		GND		(Function on request, to be defined)
	X1 / 9		+ 3.3 Vdc		<b>Temperature Battery</b>
	X1 / 10		GND		(If connected , the battery charger current if depending of the battery temp.)
X2	X2 / 1		ALARM	MAINS_OK	Mains Present
	X2 / 2				<b>Mains Failure</b>
	X2 / 3				Common
	X2 / 4		Message	LOAD_ON_INV	<b>Load on Inverter</b>
	X2 / 5				(Load on Mains bypass)
	X2 / 6				Common
	X2 / 7		ALARM	BATT_LOW	<b>Battery Low</b>
	X2 / 8				Battery OK
	X2 / 9				Common
	X3	X2 / 10		Message	LOAD_ON_MAINS
X3 / 1					(Load on Inverter)
X3 / 2				Common	
X3 / 3			ALARM	COMMON_ALARM	<b>Common Alarm (System)</b>
X3 / 4					NO Alarm Condition
X3 / 5					Common
X3 / 6			ALARM	MODUL_ALARM1	<b>Module 1 Alarm</b>
X3 / 7					NO Alarm Condition
X3 / 8					Common
X3 / 9			ALARM	MODUL_ALARM2	<b>Module 2 Alarm</b>
X3 / 10				NO Alarm Condition	
X4 / 1				Common	
X4	X4 / 2		ALARM	MODUL_ALARM3	<b>Module 3 Alarm</b>
	X4 / 3				NO Alarm Condition
	X4 / 4				Common
	X4 / 5		ALARM	MODUL_ALARM4	<b>Module 4 Alarm</b>
	X4 / 6				NO Alarm Condition
	X4 / 7				Common
	X4 / 8		ALARM		<b>Module 5 Alarm</b>
	X4 / 9				NO Alarm Condition
	X4 / 10				Common

Figure 2. Phoenix Terminals (X1...X4) Connection

On the Interface board are located two LED's:

- Green LED showing the status of the Interface:
  - Fast Blinking: 2 times/sec = Interface is Master (1<sup>st</sup> Cabinet of a parallel System)
  - Slow Blinking: 1 times/sec = Interface is Slave ( 2<sup>nd</sup>,.. 5<sup>th</sup> cabinet of a //- System)
- Red LED Board Alarm (indicates a possible replacement of the board)

On the Master board the following ports are active:

- The Input ports (X1)
- The Output port (X2, X3, X4)

On the Slave boards the following parts are active.

- The Output ports X3/6 ... X3/10 and X4/1 ...X4/10 (Means Alarm . Module 1 , 2, 3 ,4, 5)  
All other input or output ports on the Slave boards are not activated.

### 3.1.3 JD11 / RS232 Computer Interface

The **Computer Interface JD11** (4) located on the distribution part is an intelligent RS 232 serial port that allows the UPS system to be connected to a computer. The connector JD11 is a standard D-Type, 9-pin, female.

When installed the **Computer Interface**, the optional WAVEMON software allows the computer to monitor the mains voltage and the UPS system status continuously.

In the event of any changes the computer terminal will display a message.  
(For details see our optional Monitoring Package: **WAVEMON**).

### 3.1.4 JD12 / RS232 Interface for Multidrop

The **Computer Interface JD12** (5) located on the distribution part is an intelligent RS232 serial port that allows to get from several UPS cabinets which are connected in parallel the complete system information by using the Multidrop connection kit. (For details see user manual Multidrop kit). The connector JD12 is a standard D-Type, 9-pin, male.

### 3.1.5 USB/2 Computer Interface

The **Computer Interface USB** (6) located on the distribution part and is in parallel with the intelligent RS 232 serial port **JD11**.

When installed the **USB Computer Interface** trough, the optional WAVEMON software allows the computer to monitor the mains voltage and the UPS system status continuously.

In the event of any changes the computer terminal will display a message.  
(For details see our optional Monitoring Package: **WAVEMON**).

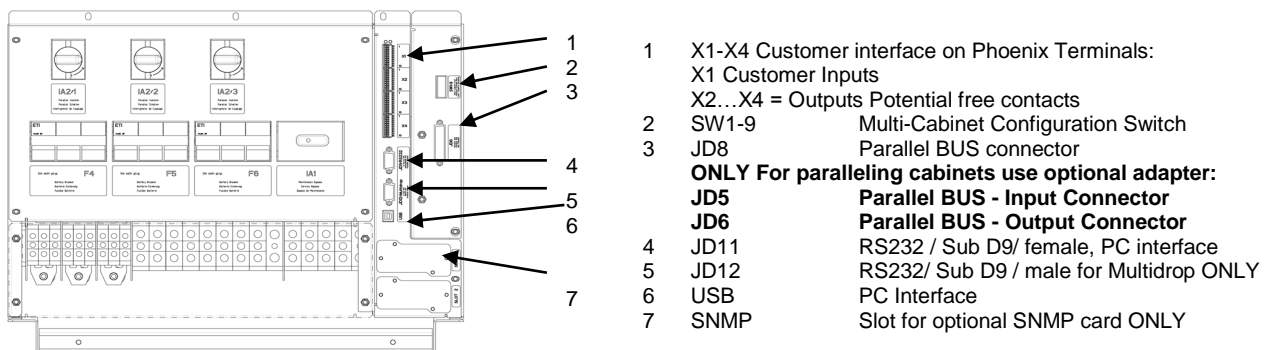

Fig. 3. Example : Distribution Interfaces

# CONTENTS SECTION-4

<b>4.1</b>	<b>OPERATION .....</b>	<b>2</b>
4.1.1	Commissioning .....	2
4.1.2	Control Panel.....	2
4.1.2.1	Power Management Display (PMD) .....	2
4.1.2.2	LED Indicators .....	3
4.1.2.3	Keys .....	3
4.1.2.4	ON/OFF Start-up and Shutdown Buttons.....	3
4.1.2.5	Definition of a Single/Parallel-Module System.....	4
4.1.2.6	Definition of a Single/ Multi-Cabinet Chain (DIP Switch SW1-9).....	4
4.1.3	Description of the LCD.....	5
4.1.3.1	Status Screens .....	5
4.1.3.2	Main Menu Screen.....	5
4.1.3.3	Event Log Screen .....	6
4.1.3.4	Measurements Screen.....	6
4.1.3.5	Commands Screen .....	6
4.1.3.6	UPS Data .....	7
4.1.3.7	Set-Up User.....	7
4.1.3.8	Set-Up Service .....	7
4.1.4	Operating Modes .....	8
4.1.4.1	Mode "ON LINE" (INVERTER MODE) .....	8
4.1.4.2	Mode"OFF-LINE"(ECO- or BYPASS MODE) .....	8
4.1.4.3	"MAINTENANCE BYPASS" - Mode .....	9
4.1.4.4	Parallel Isolator (IA2) .....	9

## 4.1 OPERATION

### 4.1.1 Commissioning

The Conceptpower DPA™ S2 is a high quality electronic machine, that must be commissioned by a fully trained and certified field service engineer before being put into use.

The commissioning of the UPS involves the connection of the UPS and battery, the checking of the electrical installation and operating environment of the UPS, the controlled start-up and testing of the UPS and customer training.

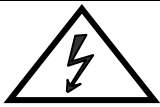

**WARNING!**

**OPERATIONS INSIDE THE UPS MUST BE PERFORMED BY A SERVICE ENGINEER FROM THE MANUFACTURER OR FROM A AGENT CERTIFIED BY THE MANUFACTURER.**

### 4.1.2 Control Panel

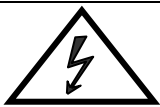

**WARNING!**

**ONLY PERSONS WHICH HAVE BEEN TRAINED BY SERVICE TECHNICIANS OF THE MANUFACTURER OR HIS CERTIFIED SERVICE PARTNERS ARE ALLOWED TO OPERATE ON THE CONTROL PANEL WITH CLOSED DOORS.  
ALL OTHER INTERVENTIONS ON THE UPS SYSTEM HAVE TO BE DONE ONLY BY SERVICE TECHNICIANS OF THE MANUFACTURER.**

The user-friendly control panel is composed of three parts:

- POWER MANAGEMENT LCD DISPLAY (PMD);
- LED INDICATORS;
- KEYS.

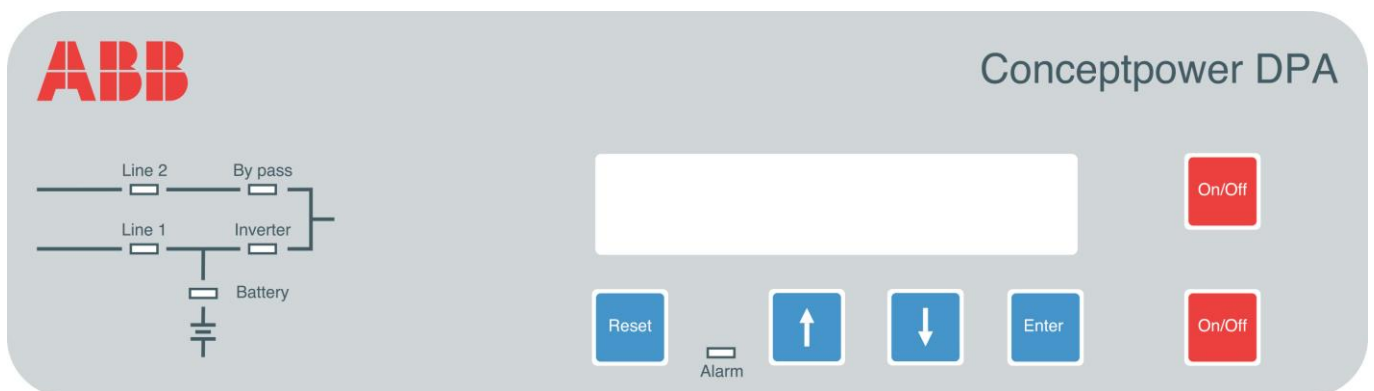

Figure 1. Control Panel

#### 4.1.2.1 Power Management Display (PMD)

The 2 x 20 character LCD simplifies the communication with the UPS and provides the necessary monitoring information about the UPS. The menu driven LCD enables the access to the:

- EVENT REGISTER;
- Monitor the input and output U, I, f, P,
- Battery runtime;
- To perform commands like start-up and shut-down of UPS and

- Load transfer from INVERTER to BYPASS and vice-versa;
- DIAGNOSIS (SERVICE MODE);
- Adjustments and testing.

#### 4.1.2.2 LED Indicators

The mimic diagram serves to indicate the general status of the UPS. The LED-indicators show the power flow status and in the event of mains failure or load transfer from inverter to bypass and vice-versa. The corresponding LED-indicators will change colours from green (normal) to red (warning).

The LED's LINE 1 (rectifier) and LINE 2 (bypass) indicate the availability of the mains power supply.

The LED's INVERTER and BYPASS if green indicate which of the two is supplying power to the critical load. When the battery is supplying the load due to mains failure the LED-indicator BATTERY is flashing.

The LED-indicator ALARM is a visual indication of any internal or external alarm condition. At the same time an audible alarm will be activated.

INDICATOR	INDICATOR STATUS	MEANING
ALARM	OFF	No alarm condition
	RED	Alarm condition
LINE 1	GREEN	Mains rectifier available
	RED	Mains rectifier not available
LINE 2	GREEN	Mains bypass available
	RED	Mains bypass not OK or not available
	OFF	UPS is turned off
BY-PASS	GREEN	Load on bypass (Bypass-or Eco-Mode)
	OFF	Bypass not operating (switched-off)
INV	GREEN	Load on inverter
	RED	Inverter fault or load not transferable to inverter
	OFF	Inverter not operating (switched-off)
BATTERY	GREEN	Battery OK
	RED	Battery fault or battery is discharged
	Flashing GREEN	Battery in discharge or battery fuse open

#### 4.1.2.3 Keys

The keys allow the user to operate the UPS to perform settings and adjustments, to start-up and shutdown the UPS, to monitor on the LCD display the voltages, currents, frequencies and other values.

KEYS	FUNCTION
ON/OFF ON/OFF	Serve to switch-on (press both keys simultaneously), or shutdown the UPS (press both keys simultaneously)
UP (↑)	Move upwards through the menu
DOWN (↓)	Move downwards through the menu.
RESET	Cancel the audible alarm. If the alarm condition was only transient the LED-indicator ALARM would also extinguish otherwise it will remain on (red).
ENTER	Confirms a chosen menu item.

#### 4.1.2.4 ON/OFF Start-up and Shutdown Buttons



**IN THE CASE THAT THE PARALLEL UPS SYSTEM HAS TO BE TURNED OFF, THEN BOTH ON/OFF BUTTONS ON ALL UPS MODULES HAVE TO BE PUSHED. IN THIS CASE THE POWER SUPPLY TO THE LOAD WILL BE INTERRUPTED**

#### 4.1.2.5 Definition of a Single/Parallel-Module System

To define a single or parallel UPS the “SET-UP SERVICE” menu, which is password protected, need to be activated using program line 4 “UPS MODEL”. See [Service Manual Section E](#).

#### 4.1.2.6 Definition of a Single/ Multi-Cabinet Chain (DIP Switch SW1-9)

By means of the DIP Switch SW1-9, which is located on the front of a Cabinet, it is possible to determine the “position” of the Cabinets in Multi-Cabinet Chain:

- “**First**” in the Multi-Cabinet Chain
- “**Middle**” in the Multi-Cabinet Chain (there may be more than one)
- “**Last**” in the Multi-Cabinet Chain.

**NOTE:** If a Cabinet is a **Single Cabinet** then it is seen as the “**First**” and “**Last**” in an imaginary Chain. So the positions of the DIP Switch SW1-9 must be set as shown below:

SW1-9	Single Cabinet	First Cabinet	Middle Cabinet	Last Cabinet
1	OFF	OFF	OFF	OFF
2	ON	OFF	OFF	ON
3	ON	ON	OFF	OFF
4	ON	ON	OFF	ON
5	ON	ON	OFF	ON
6	ON	ON	OFF	ON
7	ON	ON	OFF	ON
8	ON	ON	OFF	ON
9	ON	ON	OFF	ON

### 4.1.3 Description of the LCD

#### 4.1.3.1 Status Screens

##### DESCRIPTION

- 1 Load is protected by UPS power.  
Load is supplied by inverter (Normal Operation) and the batteries are connected and o.k.
- 2 Load is not protected by UPS power.  
Load is supplied by mains power (load on bypass) or it is supplied by the inverter (Normal operation) and the batteries are not o.k.
- 3 Load not supplied.  
UPS is switched off  
To start the UPS press the two ON/OFF push buttons simultaneously
- 4 The UPS is not supplying load anymore. The output switch is open

##### LCD-DISPLAY

<b>LOAD PROTECTED</b>	<b>S</b>
-----------------------	----------

<b>LOAD NOT PROTECTED</b>	<b>P01</b>
---------------------------	------------

<b>LOAD OFF SUPPLY FAILURE</b>	<b>P09</b>
--------------------------------	------------

<b>LOAD DISCONNECTED PARALLEL SWITCH OPEN</b>	<b>P20</b>
---	------------

**NOTE:** On the right hand side of the LCD there is the indication of single /parallel UPS.  
If the UPS is configured as single the indication will be "S"  
If the UPS is configured as parallel the indication will be "P" followed by the UPS number  
The max no. of module units are 20 per system.

##### EXEMPLES:

- S** stands for Single UPS. The system consists of ONLY one UPS (e.g. Classic cabinet)
- P01** stands for Parallel UPS in a Multi-UPS system and 01 stands for the first Module (MASTER) in the Multi-UPS system.
- P09** stands for Parallel UPS in a Multi-UPS system and 09 stands for the ninth Module (SLAVE) in the Multi- UPS system.
- P20** stands for Parallel UPS in a Multi-UPS system and 20 stands for the twentieth Module (SLAVE) in the Multi- UPS system.

The configuration of the single / parallel UPS is achieved in the Menu "SET UP SERVICE". See Service Manual section E.

#### 4.1.3.2 Main Menu Screen

##### DESCRIPTION

- 1 Logging Control. A log of the last 64 events is stored in the Power Management Display.
- 2 In Menu Measurements: monitor voltages, power,frequencies, currents, autonomy etc.
- 3 The Command Menu enables to perform the commands "Load to inverter", Load to bypass, battery test.
- 4 The UPS Data are the UPS personalized information "serial number"
- 5 Various settings can be performed by the user: Date/Time, automatic battery test, etc.
- 6 Various adjustments can be performed by the service staff

##### LCD-DISPLAY

→ <b>EVENT LOG</b>
<b>MEASUREMENTS</b>
→ <b>MEASUREMENTS</b>
<b>COMMANDS</b>
→ <b>COMMANDS</b>
<b>UPS DATA</b>

→ <b>UPS DATA</b>
<b>SET-UP USER</b>
→ <b>SET-UP USER</b>
<b>SET-UP SERVICE</b>
→ <b>SET-UP SERVICE</b>
<b>NO MORE MENU</b>

**4.1.3.3 Event Log Screen**

**DESCRIPTION**

- 1 Logging Control; a log of the last 64 events is stored in the Power Management Display.
- 2 Every stored event is identified with a sequential number and time stamp.
- 3 All events and alarms are indicated with their date and time of appearance.

**LCD-DISPLAY**

<b>01</b>	<b>05-10-00</b>	<b>14-38-59</b>
<b>LOAD TO INV.</b>		
<b>02</b>	<b>05-10-00</b>	<b>14-38-56</b>
<b>LOAD TO BYP.</b>		
<b>03</b>	<b>05-10-00</b>	<b>14-37-14</b>
<b>LOAD OFF</b>		

**4.1.3.4 Measurements Screen**

**DESCRIPTION**

- 1 Battery Runtime
- 2 UPS-Output Frequency
- 3 Bypass Frequency.
- 4 Battery Voltage
- 5 Battery Charger Current
- 6 Discharge Current.
- 7 Rectifier Voltage of all three phases
- 8 Bypass Voltage of all three phases
- 9 Output Voltage of all three phases
- 10 Output Current of all three phases
- 11 Active Output Power of all three phases
- 12 Reactive Output Power of all three phases
- 13 Apparent Output Power of all three phases
- 14 Output Power of all three phases
- 15 Battery capacity

**LCD-DISPLAY**

<b>BATT. RUN TIME (MIN)</b> 00h 00m
<b>OUTPUT FREQUENCY (HZ)</b> 50.00
<b>BYPASS FREQUENCY (HZ)</b> 50.00
<b>BATTERY VOLTAGE (V)</b> + 0.0 - 0.0
<b>BATT. CHARGE CUR. (A)</b> + 0.0 - 0.0
<b>DISCHARGE CURRENT (A)</b> 00.00
<b>RECTIFIER VOLTAGE (V)</b> 230 230 230
<b>BYPASS VOLTAGE (V)</b> 230 230 230
<b>OUTPUT VOLTAGE (V)</b> 230 230 230
<b>OUTPUT CURRENT (A)</b> 00.00 00.00 00.00
<b>ACTIVE POWER (KW)</b> 00.00 00.00 00.00
<b>REACTIVE POWER (kVAr)</b> 00.00 00.00 00.00
<b>APPARENT POWER (KVA)</b> 00.00 00.00 00.00
<b>OUTPUT POWER (%)</b> 00.00 00.00 00.00
<b>BATT. CAPACITY (%)</b> 00.00

**4.1.3.5 Commands Screen**

**DESCRIPTION**

- 1 Transfer Load to inverter
- 2 Transfer Load to bypass.
- 3 Battery Test

**LCD-DISPLAY**

<b>→ LOAD TO INVERTER</b> <b>LOAD TO BYPASS</b>
<b>→ LOAD TO BYPASS</b> <b>PERFORM BATT.TEST</b>
<b>→ PERFORM BATT.TEST</b> <b>NO MORE COMMANDS</b>



**4.1.3.6 UPS Data****DESCRIPTION**

- 1 These general UPS Data are installed at the manufacturing plant
- 2 Manufacturing date
- 3 EPROM Version
- 4 Actual Date and Time

**LCD-DISPLAY**

<b>UPS SERIAL NUMBER</b> NW-nnnnn	
<b>DATE OF MANUFACTURE</b> 15-01-2003	
<b>EPROM VERSION</b> V-000	
<b>DATE</b> dd-mm-yyyy	<b>TIME</b> hh:mm:ss

**4.1.3.7 Set-Up User****DESCRIPTION**

- 1 Set-up Language
- 2 Set-up Date and Time
- 3 Set-up battery test
- 4 Set-up operation with Gen-Set

**LCD-DISPLAY**

→ <b>SET LANGUAGE</b> SET DATE AND TIME
<b>ENGLISH</b> <b>FRANCAIS</b> <b>POLISH</b>
→ <b>SET-UP DATE/TIME</b> SET-UP BATT. TEST
<b>DD-MM-YY HH-MM-SS</b>
→ <b>SET BATTERY TEST</b> SET GENERATOR OP.
<b>DAY OF MONTH</b> (1-31)
<b>HOUR OF DAY</b> (1-24)
<b>REPETITIVE (Y/N)</b> YES/NO
→ <b>SET GENERATOR OP.</b> NO MORE SETTINGS
<b>BATT.CHARGE LOCK</b> YES/NO
<b>BYPASS LOCK</b> YES/NO

**4.1.3.8 Set-Up Service****DESCRIPTION**

- 1 This Menu is reserved for certified service engineers. It is not to be used by End-Users
- 2 Type in password

**LCD-DISPLAY**

→ <b>SET-UP SERVICE</b> PASSWORD
→ <b>PASSWORD.</b>

Password is necessary to enter: Service Manual

### 4.1.4 Operating Modes

#### 4.1.4.1 Mode "ON LINE" (INVERTER MODE)

The ON-LINE-Mode is the UPS-Operating Mode in which the load is supplied through the RECTIFIER and INVERTER.

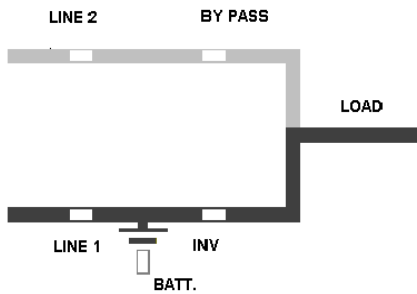

LED Indicator	Colour
LINE 1	Green
LINE 2	Green
BYPASS	OFF
INVERTER	Green
BATTERY	Green

Using the control panel (see figure 1.1), the UPS can easily be transferred to the ON-LINE-Mode. The ON-LINE-Mode provides the highest degree of protection, especially in the event of a mains disturbance or failure.

This operating mode is always recommended if the critical loads (computer systems) will not tolerate any interruption of the supply (not even the shortest).

In the unlikely event of an inverter fault or overload condition the UPS will transfer the load automatically and without interruption to the static bypass-mains supply (transfer time = 0).

#### 4.1.4.2 Mode "OFF-LINE"(ECO- or BYPASS MODE)

In the "OFF-Line Mode", the load is supplied from the mains through the static bypass.

Using the control panel (see figure 1.), the UPS may be easily transferred to "Bypass Mode".

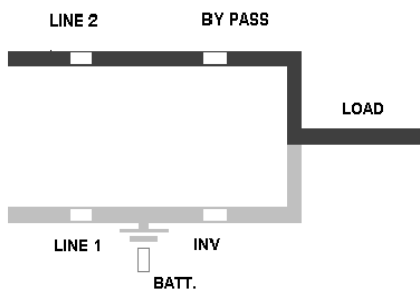

LED Indicator	Colour
LINE 1	Green
LINE 2	Green
BYPASS	Green
INVERTER	OFF
BATTERY	Green

When the UPS is operating in "Bypass Mode", the efficiency of the system is higher. In the event of a mains failure the load will automatically be transferred from mains to inverter within 5 msec (this is valid for single and parallel systems). The battery charger remains active in the "Bypass-Mode".

The "Bypass-Mode", is recommended only if the loads can tolerate interruptions of 3-5 ms (transfer time from Bypass Mode to ON-LINE Mode).



**TO HAVE TO MOST ESSENTIAL SECURITY LEVEL, WE RECOMMEND TO RUN THE UPS ON NORMAL OPERATION MODE, MEANS UPS MODE.**

#### 4.1.4.3 "MAINTENANCE BYPASS" - Mode

The Maintenance Bypass Mode is performed by means of the IA1 BYPASS SWITCH on the front of the UPS:

POSITION OF SWITCH	EFFECT
ON	Bypass-Switch Closed (Load supplied directly from mains) LCD-indication: "MANUAL BYP IS CLOSED" LED Indicators will indicate as shown in table below.
OFF	Bypass-Switch Open – Normal operating condition (Load supplied by inverter) LCD-indication "MANUAL BYP IS OPEN" LED Indicators will indicate as shown in table below.

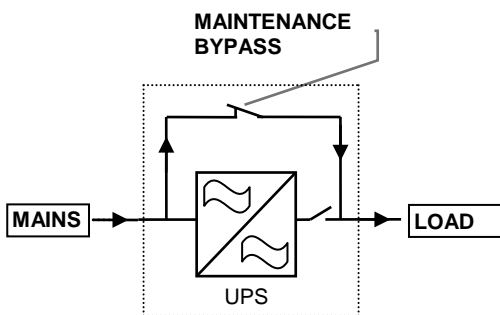

LED Indicator	ON	OFF
LINE 1	Green	Green
LINE 2	Green	Green
BYPASS	Green	OFF
INVERTER	RED	Green
BATTERY	Green	Green

Before transferring the load to Maintenance Bypass (IA1) always make sure all the UPS-modules are in the "Bypass-Mode" or "ECO-Mode".



**ON OPERATION MODE „MANUAL BYPASS“ THE LOAD IS NOT PROTECTED AGAINST ANY MAINS FAILURES OR MAINS DISTURBANCES.**

#### 4.1.4.4 Parallel Isolator (IA2)

Every UPS-unit (module) is provided with an output parallel isolator (IA2) which, when opened isolates the corresponding unit (module) from the PARALLEL BUS and from the LOAD. Once IA2 is open there is no power coming from its inverter.

In redundant parallel configurations it is used to isolate a unit from the parallel system without the need of transferring the load to bypass.

POSITION	EFFECT
ON	Normal Operation (Load supplied by UPS)
OFF	UPS-Module isolated from Parallel Bus for maintenance or module replacement (UPS-Module not supplying load)

**This page left intentionally blank**

# CONTENTS SECTION-5

<b>5.1</b>	<b>OPERATION - PROCEDURES .....</b>	<b>2</b>
5.1.1	Start-Up Procedure.....	2
5.1.2	Shutdown Procedure .....	5
5.1.3	Load Transfer: from Inverter operation to Maintenance Bypass .....	6
5.1.4	Load Transfer: from Maintenance Bypass to Inverter operations .....	7
<b>5.2</b>	<b>REPLACEMENT OF UPS-MODULE .....</b>	<b>8</b>
5.2.1	Replacement of UPS-Module in Single-Module Systems.....	8
5.2.1.1	How to Extract a UPS-Module in SINGLE MODULE Systems .....	8
5.2.1.2	How to Fit Back a UPS-Module in SINGLE-MODULE-Systems .....	9
5.2.2	Replacement of UPS-Module in Redundant Multi-Module System.....	11
5.2.2.1	How to Extract a Module in Redundant Multi-Module System.....	11
5.2.2.2	How to insert a module in a Redundant Multi Module System.....	11
5.2.3	Replacement of a Module in Capacity Multi-Module System.....	13
5.2.3.1	How to Extract a Module in a Capacity Multi-Module System.....	13
5.2.3.2	How to Fit Back a Module in a Capacity Multi-Module System.....	14

## 5.1 OPERATION - PROCEDURES

### 5.1.1 Start-Up Procedure

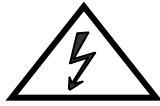

**WARNING!**

**THE OPERATIONS DESCRIBED IN THIS CHAPTER MUST BE PERFORMED BY A SERVICE ENGINEER FROM THE MANUFACTURER OR FROM A AGENT CERTIFIED BY THE MANUFACTURER.**

#### Situation of UPS-System before switching it on:

1. Make sure the fuses for the supply of UPS-System in the Input Distribution Board on site are open.
2. Make sure all the input and output cabling has been performed correctly and check the input phase rotation.
3. Verify that all Parallel Isolator Switches IA2-1, IA2-2, IA2-3, IA2-4, IA2-5 (depending of the UPS frames) are open (Position OFF).
4. Verify that the Maintenance Switch IA1 is open and in Position OFF.
5. Make sure all the internal battery fuses in the UPS (if any) and the external battery cabinets are open.
6. Check the Position of the DIP Switches SW1-9. This is a **Single- Cabinet** Configuration, and the DIP Switches SW1-9 must be set according to positions shown in section 4 Table of Paragraph 4.1.2.6

#### Start up procedure of Conceptpower DPA™:

1. Insert fuses for the supply of UPS-System in the Input Distribution
  - The LED-indicators LINE 1 and battery on UPS-Module is lit – green
  - On LCD-Display “LOAD OFF, SUPPLY FAILURE” will appear.
2. UPS-Module 1:  
Press both “ON/OFF” Main Buttons to switch on UPS.  
LCD panel must display: “LOAD DISCONNECTED PARALLEL SWITCH OPEN” and the LED-indicator will appear as shown below:

LED Indicator	Colour
LINE 1	Green
LINE 2	Green
BYPASS	Green
INVERTER	OFF
BATTERY	Flashing Green

3. Check Command: LOAD TO INVERTER  
LED indicator will appear as shown below:

LED Indicator	Colour
LINE 1	Green
LINE 2	Green
BYPASS	OFF
INVERTER	Green
BATTERY	Flashing Green

4. Scroll through the menu measurement and check their correctness
5. Module 2: Repeat same procedure as for Module 1:Steps **2)-4)**.
6. Module 3: Repeat same procedure as for Module 1:Steps **2)-4)**.
7. Module 4: Repeat same procedure as for Module 1:Steps **2)-4)**.
8. Module 5: Repeat same procedure as for Module 1:Steps **2)-4)**.
9. Check battery polarity and voltage.
10. If the battery polarity and voltage is correct insert internal (if any) and external battery fuses (breakers).
11. Testing of Parallel Functions  
(The load fuses in output Distribution Board are still open i.e. the loads are disconnected!).  
All UPS-Modules are on INVETER MODE
12. Press simultaneously the two ON/OFF buttons on the UPS-control panel (PMD) on all control panels to turn the modules OFF. On the LCD's message "LOAD OFF, SUPPLY FAILURE" will appear
13. Close Parallel Isolator IA2-1 (position ON) of Module 1, on LCD: "PARALLEL SW CLOSED" will appear.  
Close Parallel Isolator IA2-2 (position ON) of Module 2, on LCD: "PARALLEL SW CLOSED" will appear.  
Close Parallel Isolator IA2-3 (position ON) of Module 3, On LCD: "PARALLEL SW CLOSED" will appear.  
Close Parallel Isolator IA2-4 (position ON) of Module 4, On LCD: "PARALLEL SW CLOSED" will appear  
Close Parallel Isolator IA2-5 (position ON) of Module 5, On LCD: "PARALLEL SW CLOSED" will appear
14. Press simultaneously the two ON/OFF buttons on the UPS-control panel (PMD) on all control panels to turn the modules ON. On output Terminal Block there is now UPS power and on all LCD's: "LOAD PROTECTED" will appear.
15. Load transfer to Maintenance Bypass  
Go to Menu COMMANDS and choose command "LOAD TO BYPASS" and transfer the load to mains on control panel of any one of the UPS-modules.  
Close Maintenance Bypass Switch IA1 (position ON)  
On LCD: "MANUAL BYP IS CLOSED" will appear and the LED-indicator will indicate as shown below:

LED Indicator	Colour
LINE 1	Green
LINE 2	Green
BYPASS	Green
INVERTER	RED
BATTERY	Green

16. Connect Load to the UPS Output  
Insert fuses in output Distribution Board  
Verify on control Panel that the load is on bypass
17. Open Maintenance Bypass Switch IA1  
On LCD: "MANUAL BYP IS OPEN" will appear followed by "LOAD NOT PROTECTED"
18. Check on LCD the Output Powers, Voltages Currents and Frequencies.
19. Load transfer to Inverter  
Go to Menu COMMANDS and choose command "LOAD TO INVERTER" and transfer the load to inverter on control panel of any one of the three UPS-modules.  
On all LCD's: "LOAD PROTECTED" will appear followed by
20. Check the output Voltages and Currents once again.

**THE LOAD IS NOW PROTECTED BY THE CONCEPTPOWER DPA™**



### 5.1.2 Shutdown Procedure

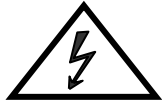

**WARNING!**

**THE OPERATIONS DESCRIBED IN THIS CHAPTER MUST BE PERFORMED BY A SERVICE ENGINEER FROM THE MANUFACTURER OR FROM A AGENT CERTIFIED BY THE MANUFACTURER.**

The **CONCEPTPOWER DPA™** may be shutdown completely, if the load does not need input power for an extended period of time.

It may be switched to Maintenance Bypass Mode for service or maintenance purposes, or transferred to the OFF-LINE Mode (ECO-Mode), if the load does not need the highest degree of protection.

The load may be disconnected by means of the two ON/OFF (LOAD-OFF) buttons for security reasons.

#### **Complete Shutdown procedure of CONCEPTPOWER DPA™ S2:**

Only in case there is no need to supply the load, the UPS System can be completely shutdown. The following procedures can only be executed after the load has completely been de-energized.



**NOTE!**

**IN THE CASE THAT THE PARALLEL UPS SYSTEM HAS TO BE TURNED OFF, THEN BOTH ON/OFF BUTTONS ON ALL UPS MODULES HAVE TO BE PUSHED. IN THIS CASE THE POWER SUPPLY TO THE LOAD WILL BE INTERRUPTED.**

1. Verify that the loads are shutdown and that there is no need for power supply to the load.
2. If the loads are all disconnected, press simultaneously both ON/OFF-Buttons on UPS-Control Panel on all three Control Panels.  
On the LCD: "LOAD OFF, SUPPLY FAILURE" will appear and the LED-indicator will indicate as shown below:

LED Indicator	Colour
LINE 1	Green
LINE 2	OFF
BYPASS	OFF
INVERTER	OFF
BATTERY	Green

3. Open all Parallel Isolator Switches IA2-1, IA2-2, IA2-3, IA2-4, IA2-5 (depending of the UPS frames).
4. Open battery fuses/breakers on internal (if any) and external battery cabinets or racks.
5. Open the mains fuses/breaker in the building distribution panel.



**NOTE!**

**MAKE SURE THE INTERNAL DC-CAPACITORS (ELCO) HAVE BEEN DISCHARGED WAITING AT LEAST 5 MINUTES.**

**THE CONCEPTPOWER DPA™ S2 IS NOW VOLTAGE FREE.**

### 5.1.3 Load Transfer: from Inverter operation to Maintenance Bypass

If it is necessary to perform service or maintenance on the UPS it is possible to transfer the UPS to MAINTENANCE BYPASS.

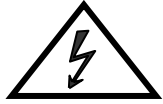

**WARNING!**

**THE OPERATIONS DESCRIBED IN THIS CHAPTER MUST BE PERFORMED BY A SERVICE ENGINEER FROM THE MANUFACTURER OR FROM A AGENT CERTIFIED BY THE MANUFACTURER.**

#### **Situation of UPS-System before starting the Transfer Procedure to Maintenance Bypass:**

The load is protected by Conceptpower DPA™ running in normal operation. (The UPS-Module is operating on inverter).

1. Using LDC panel, select the COMMANDS menu and choose command “LOAD TO BYPASS” and transfer the load to mains on control panel of any one of the three UPS-modules  
On LCD panel “LOAD NOT PROTECTED” will appear.
2. Close Maintenance Bypass Switch IA1 (position ON).  
On LCD: “MANUAL BYP IS CLOSED” will appear and the mimic panel will show:

LED Indicator	Colour
LINE 1	Green
LINE 2	Green
BYPASS	Green
INVERTER	RED
BATTERY	Green

3. Press simultaneously the two ON/OFF buttons on the UPS-control panel (PMD) on all control panels.  
On the LCD's message “LOAD OFF, SUPPLY FAILURE” will appear and the mimic panel will show:

LED Indicator	Colour
LINE 1	Green
LINE 2	OFF
BYPASS	OFF
INVERTER	OFF
BATTERY	Flashing Green

4. Open Parallel Isolators IA2-1, IA2-2, IA2-3, IA2-4, IA2-5 (depending of the UPS frames).
5. Open battery fuses/breakers on the internal (if any) and the external battery cabinets or racks.



**NOTE!**

**THE UPS SYSTEM IS STILL POWERED (DANGEROUS VOLTAGE).**



**NOTE!**

**THE LOAD IS NOW SUPPLIED BY MAINS AND IS THEREFORE NOT PROTECTED THROUGH THE UPS.**

### 5.1.4 Load Transfer: from Maintenance Bypass to Inverter operations

This procedure describes the sequence of operations to be done in order to restart the UPS and restore ON-LINE mode (Load on Inverter).

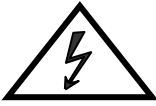

**WARNING!**

**THE OPERATIONS DESCRIBED IN THIS CHAPTER MUST BE PERFORMED BY A SERVICE ENGINEER FROM THE MANUFACTURER OR FROM A AGENT CERTIFIED BY THE MANUFACTURER.**

#### Situation of UPS-System before starting the Transfer Procedure to ON-LINE mode:

The load is supplied directly by Input Mains power and the UPS is OFF.

1. Close battery fuses/breakers in the external battery cabinets or racks.
2. On the LCD's: "LOAD OFF, SUPPLY FAILURE" will appear and the mimic panel will show:

LED Indicator	Colour
LINE 1	Green
LINE 2	OFF
BYPASS	OFF
INVERTER	OFF
BATTERY	Flashing/Green

3. Close Parallel Isolators IA2-1, IA2-2, IA2-3, IA2-4, IA2-5 (depending of the UPS frames) and check message "PARALLEL SW CLOSED" on LCD of each module.
4. Press simultaneously the two ON/OFF buttons on the UPS-control panel (PMD) on all control panels. Unit will start-up and after about 60 seconds the mimic panel will show:

LED Indicator	Colour
LINE 1	Green
LINE 2	Green
BYPASS	Green
INVERTER	RED
BATTERY	Green

5. Make sure that the bypass LED is green, then open the Maintenance Bypass Switch IA1 (position OFF).
6. Using LDC panel, select the COMMANDS menu and choose command "LOAD TO INVERTER". This will transfer the LOAD to Inverter on the complete system (all units). On LCD panel "LOAD PROTECTED" will appear.

**THE LOAD IS NOW SUPPLIED BY INVERTER POWER AND IS PROTECTED**

## 5.2 REPLACEMENT OF UPS-MODULE

### 5.2.1 Replacement of UPS-Module in Single-Module Systems



**WARNING!**

THE OPERATIONS DESCRIBED IN THIS CHAPTER MUST BE PERFORMED BY A SERVICE ENGINEER FROM THE MANUFACTURER OR FROM A AGENT CERTIFIED BY THE MANUFACTURER.

#### 5.2.1.1 How to Extract a UPS-Module in SINGLE MODULE Systems

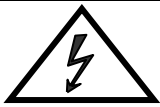

**WARNING!**

The weight of a UPS module can reach 50kg, therefore it can be lifted only by 2 persons. Potential dangers:

the ups module due to its heavy weight, if removed inappropriately, can cause serious injury or damage should the module fall down.

**note:**

it is forbidden that the modules are handled by single persons.

**SUITABLE LIFTING TOOLS RESPECTIVELY SAFEGUARD PLATFORMS AGAINST EVT. FALL DOWN ARE TO BE PLANNED. THE MODULE MUST NEVER BE CARRIED BY ONE PERSON ONLY.**

If your **CONCEPTPOWER DPA™ S2** consists of only one single UPS-Module then perform following steps to extract the module:

1. Reset the Alarm on faulty Module. The audible noise will stop.  
If the Alarm condition persists (the LED-Indicator ALARM will remain red) it means that there is a fault in the UPS-Module.
2. If the load is supplied by the mains in Bypass-Mode (Eco-Mode) the Maintenance Bypass (IA1) may be closed by turning it to position "ON".  
**NOTE:** If the load is on inverter then before closing the Maintenance Bypass IA1, transfer load to bypass by means of the command "LOAD TO BYPASS" in submenu COMMANDS. On LCD: "LOAD NOT PROTECTED" will appear.
3. Close Maintenance Bypass Switch IA1 (position ON)  
On LCD: "MANUAL BYP IS CLOSED" will appear and the LED-indicator will indicate as shown below:

LED Indicator	Colour
LINE 1	Green
LINE 2	Green
BYPASS	Green
INVERTER	RED
BATTERY	Green

**The load is now directly supplied by mains and is not protected**

**NOTE!**

**THE LOAD IS NOW DIRECTLY SUPPLIED BY MAINS AND IS NOT PROTECTED.**

4. Open the Parallel Isolator Switch IA2 (switch to position "OFF") of the faulty UPS-Module. The UPS-Module is now disconnected from output;
5. Press both ON/OFF Buttons on UPS-Module simultaneously;
6. Open battery fuses/breakers on the internal (if any) and the external battery cabinet or rack;
7. Disconnect cables from connectors JD7
8. Unscrew the four screws on the front side of the module that are fixing it to the UPS-frame;
9. Pull Module only partly horizontally by means of the 2 black handles until the rear connectors are disconnected.

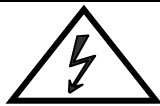
**WARNING!**

**THE LOAD IS NOW DIRECTLY SUPPLIED BY MAINS AND IS NOT PROTECTED.**

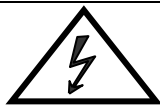
**WARNING!**

**BEFORE DRAWING THE UPS-MODULE COMPLETELY OUT, WAIT 5 MINUTES UNTIL THE INTERNAL DC-CAPACITORS ARE DISCHARGED.**

10. Draw UPS-Module by pulling it out horizontally:  
**NOTE:** Two persons are needed to pull out the module from the UPS-Frame. The weight of a DPA 50 S2, 40 kW module is 46.8kg (the weight of DPA 30 S2 , 24kW module is 43.1kg)
11. Insert new UPS-Module or cover the opening (UPS-Module Compartment) with appropriate protection cover immediately and fix with four screws.



---

**WHILE THE UPS IS OPERATING IN THE MAINTENANCE BYPASS-MODE THE LOAD IS NOT PROTECTED AND IN THE EVENT OF A MAINS FAILURE THE LOAD SUPPLY WILL BE INTERRUPTED AND THE LOAD WILL CRASH.**

---

#### **5.2.1.2 How to Fit Back a UPS-Module in SINGLE-MODULE-Systems**

If your **CONCEPTPOWER DPA™ S2** consists of only one single UPS-Module then perform following steps to fit back the new module:

1. Remove UPS-Module compartment protection cover by unscrewing four screws on the front.
2. Slide two thirds of UPS-Module into dedicated UPS-compartment (make sure not to plug the UPS-Module into the rear connector).  
Connect Control Panel cable to connector JD7.  
Push UPS-module to its final position and push strongly to assure good contact on the rear plugs.  
**NOTE:** Two persons are needed to pull out the module from the UPS-Frame. The weight of a DPA 50 S2, 40 kW module is 46.8kg (the weight of DPA 30 S2 , 24kW module is 43.1kg)
3. Tighten the four screws on the front of module.

4. Check if the LED LINE1 and battery is green. If yes, mains voltage is OK;  
On the LCD: "LOAD OFF, SUPPLY FAILURE" will appear and the LED-indicator will indicate as shown below:

LED Indicator	Colour
LINE 1	Green
LINE 2	OFF
BYPASS	OFF
INVERTER	OFF
BATTERY	Flashing Green

5. Close internal and external battery fuses/breaker (if available);
6. Press simultaneously both "ON/OFF" Buttons to start-up UPS.  
LCD panel must display: "LOAD DISCONNECTED PARALLEL SWITCH OPEN" and the LED-indicator will appear as shown below:

LED Indicator	Colour
LINE 1	Green
LINE 2	Green
BYPASS	OFF
INVERTER	Green
BATTERY	Green

7. Transfer load to mains and inverter for testing using submenu COMMANDS
8. Transfer Load to Bypass-Mode by means of COMMAND "LOAD TO BYPASS"
9. Verify the status (Load on Bypass, Eco-Mode) by checking the LED-indicators as shown below:

LED Indicator	Colour
LINE 1	Green
LINE 2	Green
BYPASS	Green
INVERTER	OFF
BATTERY	Green

10. Close Parallel Isolator (IA2);
11. Open Maintenance Bypass (IA1) by turning it to position "OFF". The load is now supplied by the static bypass.
12. Transfer load to Inverter-Mode by means of COMMAND "LOAD TO INVERTER". On LCD: "LOAD PROTECTED" will appear.

**THE LOAD IS NOW PROTECTED BY THE CONCEPTPOWER DPA™ S2**

## 5.2.2 Replacement of UPS-Module in Redundant Multi-Module System

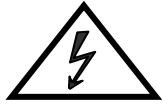

**WARNING!**

THE WEIGHT OF A UPS MODULE CAN REACH 50KG, THEREFORE IT CAN BE LIFTED ONLY BY 2 PERSONS. THE MODULE MUST NEVER BE CARRIED BY ONE PERSON ONLY.



**WARNING!**

MAKE SURE THE INTERNAL DC-CAPACITORS (ELCO) HAVE BEEN DISCHARGED WAITING AT LEAST 5 MINUTES. HOW TO EXTRACT A MODULE IN REDUNDANT MULTI-MODULE SYSTEM

### 5.2.2.1 How to Extract a Module in Redundant Multi-Module System

If in a redundant parallel system a UPS-module is faulty, the load will continue to be protected by the operating modules On-Line-Mode (Inverter-Mode) and the faulty Module may be replaced without having to transfer the load to bypass!

To extract the faulty module from the UPS-Frame in a Redundant Multi- Module Configuration proceed as follows:

1. Identify the faulty Module with the Alarm condition and RESET the Alarm. The audible noise will stop. If the Alarm conditions persists (the LED-Indicator ALARM is red) there is a fault in the UPS-Module.
2. Verify that load is supplied by inverter of the other modules running by checking the LCD indication LOAD PROTECTED. Verify load measures on the operating modules.
3. Turn the faulty module OFF by pressing simultaneously both "ON/OFF" buttons. On the LCD: "LOAD OFF, SUPPLY FAILURE" should appear and the LED-indicator will indicate as shown below:

LED Indicator	Colour
LINE 1	Green
LINE 2	OFF
BYPASS	OFF
INVERTER	OFF
BATTERY	Flashing Green

4. Open the corresponding Parallel Isolator Switch IA2. LCD panel must show: PARALLEL SW OPEN.
5. Remove the 4 fixation screws and slide out the UPS-Module (10cm) paying particular attention to the cable connected to JD7. This operation will disconnect module by the power connection located on the back of the cabin.
6. With the module OFF, disconnect any connected cable as JD7.
7. Pull the module out.

**ATTENTION: BEFORE DRAWING THE UPS-MODULE COMPLETELY OUT, WAIT 5 MINUTES UNTIL THE INTERNAL DC-CAPACITORS ARE DISCHARGED.**

**NOTE:** Two persons are needed to pull out the module from the UPS-Frame. The weight of a DPA 50 S2, 40 kW module is 46.8kg (the weight of DPA 30 S2 , 24kW module is 43.1kg)

8. Screw the protection cover on the empty area left empty by the module with the 4 fixation screws.

### 5.2.2.2 How to insert a module in a Redundant Multi Module System

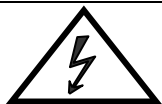

**WARNING!**

THE WEIGHT OF A UPS MODULE CAN REACH 50KG, THEREFORE IT CAN BE LIFTED ONLY BY 2 PERSONS. THE MODULE MUST NEVER BE CARRIED BY ONE PERSON ONLY

In a Redundant Parallel system one module can be re-introduced on its original location without affecting normal system operation. Load will be protected by the other modules running ON-LINE.

Module must be previously set according to system personalization. Please make sure with your nearest service centre for correct settings.

1. Remove the protection cover by unscrewing the 4 fixation screws on the front.
2. Lift the module to its destination position. See above note concerning weights.
3. Slide two thirds of UPS module into dedicated compartment (make sure not to plug the UPS-Module into the rear connector). Connect Control Panel cable to connector JD7.  
Push UPS-module to its final position and push strongly to assure good contact on the rear plugs.  
Tighten the four screws on the front of module;
4. Check if LED LINE1 and battery is green. If yes, mains voltage is OK;  
On the LCD: "LOAD OFF, SUPPLY FAILURE" will appear and the LED-indicator will indicate as shown below:

LED Indicator	Colour
LINE 1	Green
LINE 2	OFF
BYPASS	OFF
INVERTER	OFF
BATTERY	Flashing Green

5. Close internal and/or external battery fuses/breaker of the new Module
6. Press both "ON/OFF" Buttons simultaneously to start-up UPS.
7. Wait 60 seconds, LCD panel must display: "LOAD DISCONNECTED PARALLEL SWITCH OPEN" and the LED-indicator will appear as shown below:

LED Indicator	Colour
LINE 1	Green
LINE 2	Green
BYPASS	Green
INVERTER	OFF
BATTERY	Flashing/Green

8. Transfer load to Inverter-Mode by means of COMMAND "LOAD TO INVERTER" of the control panel.  
LED-indicator will appear as shown below:

LED Indicator	Colour
LINE 1	Green
LINE 2	Green
BYPASS	OFF
INVERTER	Green
BATTERY	Green

9. Stop the module by pressing simultaneously both "ON/OFF" buttons.
10. Close the Parallel Isolator Switch IA2 corresponding to the module.  
LCD panel must show the message PARALLEL SW CLOSED.
11. Press simultaneously both "ON/OFF" buttons.  
Module will restart automatically connecting load to inverter and run in parallel with other ON LINE modules. LCD panel must show LOAD PROTECTED indication.

**THE LOAD IS NOW PROTECTED BY THE CONCEPTPOWER DPA™ S2**



### 5.2.3 Replacement of a Module in Capacity Multi-Module System

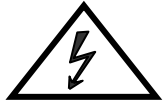

**WARNING!**

THE WEIGHT OF A UPS MODULE CAN REACH 50KG, THEREFORE IT CAN BE LIFTED ONLY BY 2 PERSONS. THE MODULE MUST NEVER BE CARRIED BY ONE PERSON ONLY

#### 5.2.3.1 How to Extract a Module in a Capacity Multi-Module System

If in capacity parallel system a UPS-Module experiences a fault and there is not enough capacity left to protect the load by the remaining operating UPS-Modules, the load will automatically be transferred to bypass (Bypass-Mode or Eco-Mode) and will continue to be supplied by the mains power supply.

To extract the faulty module from the UPS-Frame in a Capacity Multi-Module System proceed as follows:

1. Identify the faulty Module with the Alarm condition and RESET the Alarm. The audible noise will stop. If the Alarm conditions persists (the LED-Indicator ALARM is red) there is a fault in the UPS-Module.
2. Verify that the load is on Bypass and is supplied by the mains power (Bypass-Mode or Eco-Mode) on all three UPS-Modules; in the majority of the events the LED-indicators on Control Panel of the Faulty Module will show:

LED Indicator	Colour
LINE 1	Green
LINE 2	Green
BYPASS	Green
INVERTER	RED
BATTERY	Green

3. Whereas the LED-indicators on the Control Panels of the other two Operating Modules will show

LED Indicator	Colour
LINE 1	Green
LINE 2	Green
BYPASS	Green
INVERTER	OFF
BATTERY	Green

4. Close Maintenance Bypass Switch IA1 (position ON)
5. On LCD: "MANUAL BYP IS CLOSED" will appear and the LED-indicator will indicate as shown below:

LED Indicator	Colour
LINE 1	Green
LINE 2	Green
BYPASS	Green
INVERTER	RED
BATTERY	Green

#### **The load is now directly supplied by mains and is not protected**

6. Open the Parallel Isolator Switch IA2 (switch to position "OFF") of UPS-module to be replaced. The UPS-module is now disconnected from the output;
7. Press both ON/OFF Buttons on UPS-Module simultaneously;
8. Open corresponding battery fuses;

9. Remove the 4 fixation screws and slide out the UPS-Module (10cm) paying particular attention to the cable connected to JD7. This operation will disconnect module by the power connection located on the back of the cabin.
10. Disconnect cables from connectors JD7.

**ATTENTION: BEFORE DRAWING THE UPS-MODULE COMPLETELY OUT, WAIT 5 MINUTES UNTIL THE INTERNAL DC-CAPACITORS ARE DISCHARGED.**

11. Draw UPS-Module by pulling it out horizontally:  
**NOTE:** Two persons are needed to pull out the module from the UPS-Frame. The weight of a DPA 50 S2, 40 kW module is 46.8kg (the weight of DPA 30 S2 , 24kW module is 43.1kg)
12. Insert new UPS-Module or cover the opening (UPS-Module Compartment) with appropriate protection cover immediately and fix with four screws.

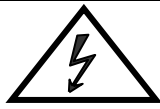

**WARNING!**

**MAKE SURE THE INTERNAL DC-CAPACITORS (ELCO) HAVE BEEN DISCHARGED WAITING AT LEAST 5 MINUTES**

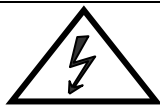

**WARNING!**

**THE LOAD IS NOW DIRECTLY SUPPLIED BY MAINS AND IS NOT PROTECTED**

### 5.2.3.2 How to Fit Back a Module in a Capacity Multi-Module System

To replace a Faulty Module in a Capacity Multi-Module System perform following steps:

1. Remove UPS-Module compartment protection cover by unscrewing four screws on the front.
2. Slide two thirds of UPS-Module into dedicated UPS-compartment (make sure not to plug the UPS-Module into the rear connector).  
Connect Control Panel cable to connector JD7.  
Push UPS-module to its final position and push strongly to assure good contact on the rear plugs.  
**NOTE:** Two persons are needed to pull out the module from the UPS-Frame. The weight of a DPA 50 S2, 40 kW module is 46.8kg (the weight of DPA 30 S2 , 24kW module is 43.1kg).
3. Tighten the four screws on the front of module;
4. Check if LED LINE1 and battery are green.  
On the LCD: "LOAD OFF, SUPPLY FAILURE" will appear and the LED-indicator will indicate as shown below:

LED Indicator	Colour
LINE 1	Green
LINE 2	OFF
BYPASS	OFF
INVERTER	OFF
BATTERY	Flashing Green

5. Close internal and/or external battery fuses/breaker of the new Module
6. Press both "ON/OFF" Buttons simultaneously to start-up UPS.  
LCD panel must display: "LOAD DISCONNECTED PARALLEL SWITCH OPEN" and the LED-indicator will appear as shown below:

LED Indicator	Colour
LINE 1	Green
LINE 2	Green
BYPASS	Green
INVERTER	OFF
BATTERY	Green

7. Transfer load to mains and inverter for testing using submenu COMMANDS
8. Transfer Load to Bypass-Mode by means of COMMAND "LOAD TO BYPASS"
9. Verify the status LOAD ON BYPASS

LED Indicator	Colour
LINE 1	Green
LINE 2	Green
BYPASS	Green
INVERTER	OFF
BATTERY	Green

10. Verify that the remaining UPS-Modules are also on Bypass;
11. If all three UPS-Modules are on Bypass, Close Parallel Isolator Switch IA2 of New Module (position ON); on LCD should appear "PARALLEL SW IS CLOSED".
12. Open Maintenance Bypass (IA1) by turning it to position "OFF". The load is now supplied by the static bypass of all three Modules. Check LED-indicators on control panels.
13. Transfer load to Inverter-Mode by means of COMMAND "LOAD TO INVERTER" on any one of three control panels. On LCD: "LOAD PROTECTED" will appear and the LED-indicator will indicate as shown below:

LED Indicator	Colour
LINE 1	Green
LINE 2	Green
BYPASS	OFF
INVERTER	Green
BATTERY	Green

**THE LOAD IS NOW PROTECTED BY THE CONCEPTPOWER DPA™ S2**

**This page left intentionally blank**

# CONTENTS SECTION-6

<b>6.1</b>	<b>MULTI-CABINET CONFIGURATION .....</b>	<b>2</b>
6.1.1	Concept of Multi-Cabinet Configuration .....	2
6.1.2	Installation Instructions .....	3
6.1.2.1	Introduction.....	3
6.1.2.2	Paralleling of UPS-Cabinets .....	3
6.1.2.2.1	Connection of Parallel Communication Cables (BUS-lines) .....	3
6.1.2.2.2	Parallel Adapter and DIP-Switch SW2-2.....	4
6.1.2.3	DIP-Switch SW1-9 Settings .....	4
6.1.2.4	DIP Switch SW1-9 .....	4
6.1.2.5	ON/OFF – Main Buttons .....	5
6.1.2.6	Parallel Isolator (IA2) .....	5
6.1.2.7	Maintenance Bypass (IA1).....	5
6.1.2.7.1	Redundant Parallel Configuration .....	5
6.1.2.7.2	Capacity Parallel Configuration.....	5
6.1.2.8	ECO-MODE (BYPASS MODE) in Parallel Systems.....	5
6.1.3	Commissioning of Multi-Cabinet Configuration .....	6
6.1.3.1	Start-up of a Multi-Cabinet Configuration .....	6
6.1.3.2	Shutdown of Multi-Cabinet Configuration.....	6
6.1.3.3	Replacement of a Faulty UPS-Module in a Multi-Cabinet Configuration.....	6

## 6.1 MULTI-CABINET CONFIGURATION

### 6.1.1 Concept of Multi-Cabinet Configuration

The **CONCEPTPOWER DPA™ S2** Cabinets may be paralleled for power capacity or for redundancy indefinitely. Every standard **CONCEPTPOWER DPA™ S2** is provided with the parallel option and therefore no time-consuming upgrading is necessary on site.

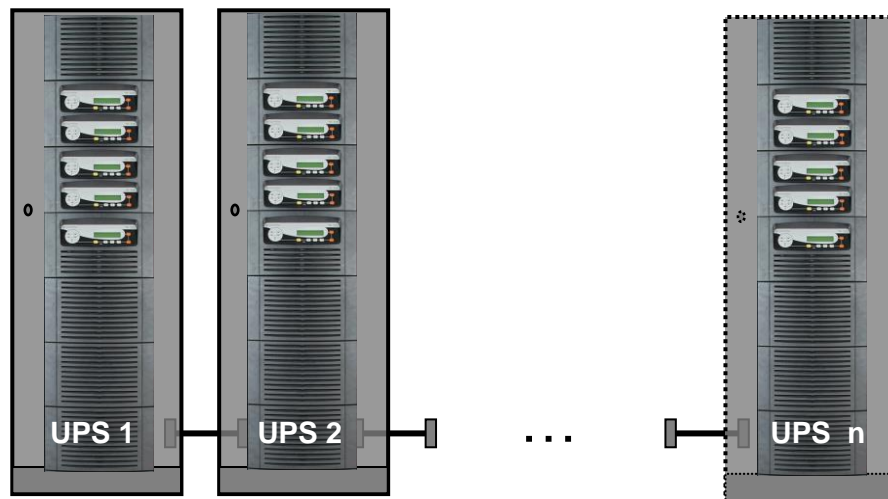

Fig. 1.1. **CONCEPTPOWER DPA™ S2** Multi-Cabinet Chain.

The Multi-Cabinet Chain is based on a decentralized bypass architecture i.e. every UPS is provided with its own static bypass. In a parallel system there is always one Master Module and the other Modules are slaves. If at any time the master is faulty the next UPS (former slave) will immediately take over the master function and the former master will switch off.

Every UPS unit in a parallel configuration is provided with a proper output parallel Isolator (IA2) which, when opened isolates the corresponding unit from the parallel system. Once the parallel isolator (IA2) of a unit is open that unit (module) is isolated from the rest of the parallel system and therefore does not provide power to the output.

For example if you perform the command "LOAD TO BYPASS" on any unit, all the units will transfer the load simultaneously to mains and if you perform the command "LOAD TO INVERTER" on any unit all the UPS's will simultaneously transfer the load to the inverters.

The **CONCEPTPOWER DPA™ S2** is paralleled for redundancy (highest availability) or for power parallel systems.

**IMPORTANT:** The BYPASS MODE (ECO-MODE) function of a parallel systems is the same as in single units of **CONCEPTPOWER DPA™ S2**. If in a parallel UPS system the load is transferred to the BYPASS (load on mains) and if the mains fails, the UPS's will all be automatically transferred to inverter within 5msec.

## 6.1.2 Installation Instructions

### 6.1.2.1 Introduction

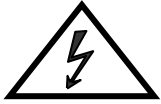

**WARNING!**

**THE OPERATIONS DESCRIBED IN THIS CHAPTER MUST BE PERFORMED BY A SERVICE ENGINEER FROM THE MANUFACTURER OR FROM A AGENT CERTIFIED BY THE MANUFACTURER.**

**NOTE:** IN ORDER TO ACHIEVE EQUAL LOAD SHARING BETWEEN THE UPS-CABINETS, THE INPUT CABLE LENGTHS FROM THE INPUT DISTRIBUTION BOARD TO THE UPS AND FROM THE OUTPUT CABLE TO THE OUTPUT DISTRIBUTION BOARD SHOULD BE THE SAME RESPECTIVELY. WHEN CABLING THE UPS'S BEWARE TO CONNECT INPUT AND OUTPUT WIRES TO THE CORRESPONDING TERMINALS, RESPECTING THE SAME PHASE SEQUENCE ON ALL UPS CABINETS. EXAMPLE: PHASE1 OF UPS1 = PHASE1 OF UPS2 = ..... = PHASE1 OF UPS n

### 6.1.2.2 Paralleling of UPS-Cabinets

#### 6.1.2.2.1 Connection of Parallel Communication Cables (BUS-lines)

For the correct performance of different parallel functions and operations the parallel units communicate continuously between each other. This is achieved by means of the so-called communication BUS-Lines.

After terminating the input and output cabling of each single UPS, it is necessary to connect the units together to form the parallel system. For this purpose a communication BUS line is connected sequentially between the units. Connect communication BUS lines according to Figure 1.2.



**NOTE!**

**CONNECT THE BUS CABLES ONLY WITH SWITCHED OFF UPS AND OPENED PARALLEL ISOLATORS IA2. RESPECT THE FOLLOWING CONNECTION SEQUENCES.**

1. Fit the Parallel Adapter over the Connector JD8 on all UPS-cabinets
2. Set DIP Switch SW2-2 on each Parallel Adapter depending on the UPS Cabinet in the parallel cabinet configuration (see section 6 chapter 6.1.2.2.2)
3. Connect PORT JD6 on Parallel Adapter of UPS-Cabinet 1 and PORT JD5 of Parallel Adapter of UPS-Cabinet 2 with the corresponding BUS-Cable;
4. Connect PORT JD6 on Parallel Adapter of UPS-Cabinet 2 and PORT JD5 of UPS-Cabinet 3 with the corresponding BUS-Cable
5. Continue in the same manner for the remaining UPS-Cabinets.

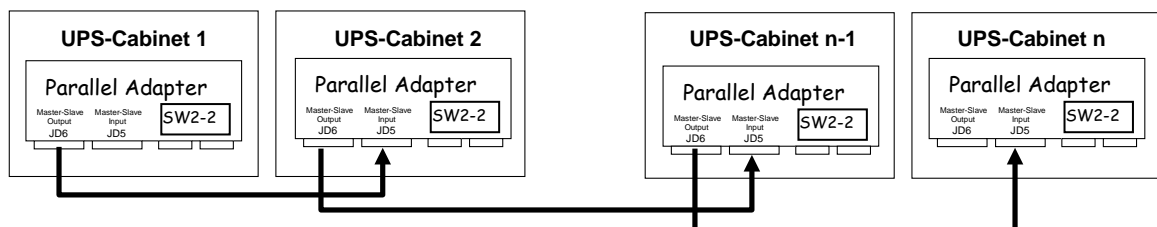
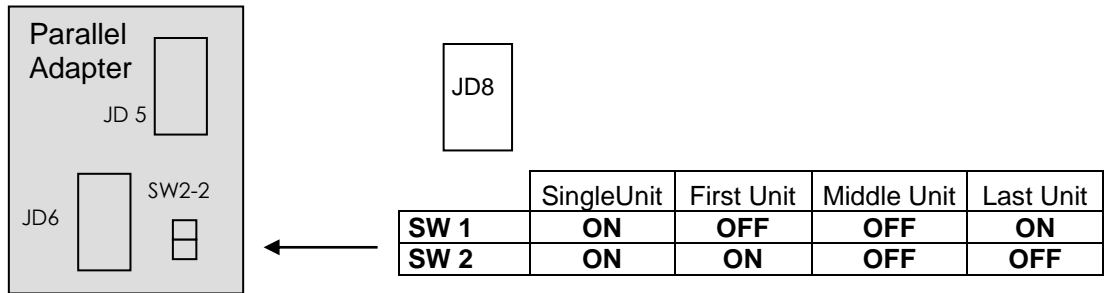

Figure 1.2. Connection of the Bus Lines when paralleling UPS-Cabinets by means of Parallel Adapters.

**6.1.2.2.2 Parallel Adapter and DIP-Switch SW2-2**

If the UPS-CABINETS are paralleled the Parallel Adapter will be placed on the Connector JD8 on the distribution panel and the communications cables between the cabinets will be connected through the connectors JD5 and JD6, as we are doing now.

NOTE: set the Switch SW2-2 correctly according to the corresponding cabinet configuration.



**6.1.2.3 DIP-Switch SW1-9 Settings**

Before starting up the parallel system it is necessary to set the DIP Switches SW1-9 to their correct positions.

**6.1.2.4 DIP Switch SW1-9**

The DIP Switch SW1-9 is located on every Cabinet (CONCEPTPOWER DPA™ S2) With this switch it is possible to determine the “**position of an CONCEPTPOWER DPA™ –S2 Cabinet**” in a Multi-Cabinet Chain. Define each **CONCEPTPOWER DPA™ S2** - Cabinet in a Multi-Cabinet Chain as:

1. The “**First**”,
2. The “**Middle**” (there may be more than one) and
3. The “**Last**”

Cabinet in the Multi-Cabinet Chain by setting the DIP Switch SW1-9 on each cabinet according to the Table below:

SW1-9	Single Cabinet	First Cabinet	Middle Cabinet	Last Cabinet
1	OFF	OFF	OFF	OFF
2	ON	OFF	OFF	ON
3	ON	ON	OFF	OFF
4	ON	ON	OFF	ON
5	ON	ON	OFF	ON
6	ON	ON	OFF	ON
7	ON	ON	OFF	ON
8	ON	ON	OFF	ON
9	ON	ON	OFF	ON

After having set the SW1-9 on all the **CONCEPTPOWER DPA™ S2** - Cabinets correctly the UPS’s may be commissioned



### 6.1.2.5 ON/OFF – Main Buttons

The ON/OFF-Buttons serve to shutdown the UPS-system for service or maintenance or for emergency reasons.



**WHEN BOTH ON/OFF BUTTONS ON ALL UPS MODULES IN A PARALLEL SYSTEM ARE PUSHED THE POWER SUPPLY TO THE LOAD WILL BE INTERRUPTED.**

### 6.1.2.6 Parallel Isolator (IA2)

Every UPS-unit (Means each Module) is provided with a parallel isolator IA2. The parallel isolator is an important element of the UPS-unit, that allows the isolation of a Module from the parallel system without the need to transfer the load to bypass.



**IA2 OPEN:  
THE CORRESPONDING UPS-MODULE IS ISOLATED FROM THE OUTPUT. THERE IS NO COMMUNICATION BETWEEN THE ISOLATED UNIT AND THE REST OF THE PARALLEL SYSTEM. THE ISOLATED UPS-MODULE MAY BE REPLACED WITHOUT COMPROMISING THE REST OF THE SYSTEM.**

**IA2 CLOSED:  
THE CORRESPONDING UPS IS BEING ADDED TO THE REST OF THE PARALLEL SYSTEM.**

**IMPORTANT: BEFORE CLOSING THE IA2 OF A UPS-MODULE BE SURE THAT THE STATUS OF THAT UPS-MODULE IS THE SAME AS OF THE REST OF THE OPERATING UPS-MODULE WITH CLOSED IA2.**

**EXAMPLE: IF ALL UPS'S WITH CLOSED IA2 ARE ON INVERTER, MAKE SURE THAT THE UNIT ON WHICH ISOLATOR IA2 IS BEING CLOSED IS ALSO ON INVERTER.**

### 6.1.2.7 Maintenance Bypass (IA1)

There are two types of Parallel System Configurations: redundant and capacity parallel systems (see SECTION 5).

#### 6.1.2.7.1 Redundant Parallel Configuration

In a redundant parallel system a UPS-module may easily be isolated from the parallel system by opening the respective isolator (IA2). It is now possible to operate or shut down this unit without influencing the rest of the parallel system. The rest of the parallel system will continue to protect the load. The isolated UPS-Module may be replaced without the need of transferring the load to bypass by means of the Maintenance Bypass (IA1).

#### 6.1.2.7.2 Capacity Parallel Configuration

In the event of a fault in one of the UPS-Modules in a capacity parallel system the load will automatically be transferred to static bypass (mains). In order to replace the faulty module the load must be transferred to mains by means of Maintenance Bypass (IA1).

### 6.1.2.8 ECO-MODE (BYPASS MODE) in Parallel Systems

The Eco-Mode function in a Parallel System is the same as in Single Systems. If in a **CONCEPTPOWER DPA™ S2** Parallel System the load is supplied by the mains(load on mains) and in the event of mains failure, **all UPS's will automatically transfer the load back to the inverters with 5msec.**



***In order to provide the load with maximum protection the manufacturer always recommends that the load be supplied by the inverter (ON-LINE-Mode).***

### 6.1.3 Commissioning of Multi-Cabinet Configuration

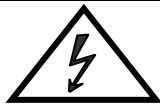

**WARNING!**

**THE OPERATIONS DESCRIBED IN THIS CHAPTER MUST BE PERFORMED BY A SERVICE ENGINEER FROM THE MANUFACTURER OR FROM A AGENT CERTIFIED BY THE MANUFACTURER.**

#### 6.1.3.1 Start-up of a Multi-Cabinet Configuration

Before starting up a Multi-Cabinet Configuration verify that:

1. All the input and output cabling has been performed correctly according to section 2 of this User Manual;
2. The parallel communication cables have been connected correctly according to Paragraph 6.1.2.2
3. All the DIP Switches for the Modules and CONCEPTPOWER DPA™ - Cabinets been set correctly according to Paragraph 6.1.2.3
4. All the internal (if any) and /or external battery cabinets/racks have been connected correctly

The start-up of a Multi-Cabinet Configuration may be performed in analogy to the start-up procedures for a single CONCEPTPOWER DPA™ - Cabinet described in Paragraph 5.1.1 of section 5.

#### 6.1.3.2 Shutdown of Multi-Cabinet Configuration

Before shutting-down of a Multi-Cabinet Configuration make sure that the loads do need power protection and that they are disconnected.



**The UPS may be shut down completely if the loads do not need any power supply. Therefore the steps in this Paragraph are to be performed only after the load has been disconnected and does not need any power supply.**

To perform a complete shutdown of a Multi-Cabinet Configuration proceed in analogy to the shutdown procedures described in Paragraph 5.1.2 of section 5.

#### 6.1.3.3 Replacement of a Faulty UPS-Module in a Multi-Cabinet Configuration

If in a Multi-Cabinet Configuration a UPS-Module fails proceed in replacing the UPS-Module in analogy with the replacement procedures described in section 5 of this User Manual

# CONTENTS SECTION-7

- 7.1 MAINTENANCE ..... 2**
- 7.1.1 User Responsibilities ..... 2
- 7.1.2 Preventative Maintenance ..... 2
- 7.1.3 Deep Battery Test..... 2
- 7.1.4 Battery maintenance, disposal and recycling ..... 3

## 7.1 MAINTENANCE



**WARNING!**

**THE OPERATIONS DESCRIBED IN THIS CHAPTER MUST BE PERFORMED BY A SERVICE ENGINEER FROM THE MANUFACTURER OR FROM AN AGENT CERTIFIED BY THE MANUFACTURER.**

### 7.1.1 User Responsibilities

There are no parts within the UPS which need to be serviced by the user, so the maintenance responsibilities of the user are zero. To maximize the useful working life and reliability of the UPS and its batteries, the environment in which the UPS operates should be kept cool (20°C - 25°C), dry, dust free and vibration free. The batteries should be hold fully charged.

### 7.1.2 Preventative Maintenance

The UPS system needs a regular and constant maintenance (preventative inspections) at least once a year, even during the warranty period.

These preventative maintenance inspections are essential to ensure a correct functionality and reliability of the UPS system. When the UPS is commissioned, the commissioning field service engineer will attach a service record book to the front of the UPS and this will be used to record the full service history of the UPS.

During a preventative maintenance the field service engineer might carry out some or all of following checks:

- Status and function check of UPS and batteries
- UPS and batteries visual inspection (dust, mechanical damages, ..)
- Visual inspection of screws and cable connections
- Check of air ventilation and room temperature
- Check the operation and function (commutations, remote monitoring and Signaling)
- Current, voltage and frequencies measures
- Measure and record the current load conditions
- Check the load sharing (only in parallel systems)
- Battery voltage check
- Battery discharge test
- Check transfer of the load from UPS to mains operation via static bypass
- Unit cleaning

### 7.1.3 Deep Battery Test

The battery test takes approx. 3 minutes and should be performed only if:

- there are no alarm conditions
- the battery is fully charged
- mains is present.

The battery testing can be carried out independently of the operation mode (OFF-LINE or ON-LINE) and whether or not the load is connected. The battery test procedure can be performed from the UPS display, in the service setup mode.

#### 7.1.4 Battery maintenance, disposal and recycling

The battery maintenance shall be done by a certified Service Partner.

To ensure an optimum operation of the UPS system and a continuous and efficient protection of the connected load it is recommended to check the batteries every 12 months.

Batteries contain dangerous substances that will harm the environment if thrown away. If you change the batteries yourself, call qualified organizations for battery disposal and recycling.

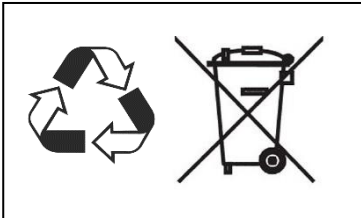

**This page left intentionally blank**

# CONTENTS SECTION-8

- 8.1 TROUBLESHOOTING ..... 2**
- 8.1.1 Alarms ..... 2
- 8.1.2 Menu, Commands, Event Log And Measurements ..... 2
- 8.1.3 Fault Identification and Rectification..... 2

## 8.1 TROUBLESHOOTING

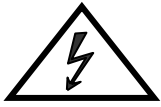

**WARNING!**

**THE OPERATIONS DESCRIBED IN THIS CHAPTER MUST BE PERFORMED BY A SERVICE ENGINEER FROM THE MANUFACTURER OR FROM A AGENT CERTIFIED BY THE MANUFACTURER.**

### 8.1.1 Alarms

In the event of an alarm condition the red LED-Indicator "Alarm" and the audible alarm will turn on. In this case proceed as follows:

1. Silence the audible alarm by pressing the button "Reset".
2. Identify the cause of the alarm condition by means of the EVENT LOG in the MAIN menu.
3. In case of doubts please contact the nearest Service centre.
4. Fault identification and rectification information is given on the following pages.

### 8.1.2 Menu, Commands, Event Log And Measurements

In section 4 there is a detailed description of the Menu, Commands, Event Log and Measurements that can be operated and displayed on the LCD. The List of Alarms and Messages are shown in the Annex.

### 8.1.3 Fault Identification and Rectification

The major alarm conditions that will be encountered are:

Alarm Condition	Meaning	Suggested Solution
MAINS RECT. FAULT	Mains power supply is outside prescribed tolerance.	The input power to UPS is too low or missing. If site power appears to be OK, check the input circuit breakers etc. supplying the UPS.
MAINS BYP FAULT	Mains power supply is outside prescribed tolerance.	The input power to UPS is too low or missing. If site power appears to be OK, check the input circuit breakers etc. supplying the UPS.
OUTPUT SHORT	There is a short circuit at the output of UPS (on load side).	Check all output connections and repair as required.
OVERLOAD	Load exceeds the UPS rated power.	Identify which piece of equipment is causing the overload and remove it from the UPS. Do not connect laser printers, photocopiers, electric heaters, kettles etc. to the UPS.
TEMPERATURE HIGH	UPS temperature has exceeded the allowed value.	Check that the ambient temperature of the UPS is less than 40° C. If the ambient temperature is normal call the certified service centre for assistance.
INV. PHASE FAULT	Inverter is faulty.	Call the certified service centre for assistance.
SYNCHRON. FAULT	The inverter and mains are not synchronised.	The frequency of the input voltage to the UPS is outside operational limits and the UPS static bypass has been temporarily disabled.
BATTERY IN DISCHARGE	Battery is near end of autonomy.	Shutdown load connected to UPS before the UPS switches itself off to protect its batteries.
MANUAL BYP IS CLOSED	Maintenance Bypass closed. Load supplied by mains.	This alarm is only displayed if the UPS is on Maintenance Bypass.

In case of alarms not included in the list above, please contact the nearest certified service centre for assistance.



# CONTENTS SECTION-9

<b>9.1</b>	<b>OPTIONS .....</b>	<b>2</b>
9.1.1	Introduction.....	2
9.1.2	Remote SHUT DOWN .....	2
9.1.3	Generator ON Facilities .....	3
9.1.4	Wavemon Shutdown and ManagementSoftware .....	3
9.1.4.1	Why is UPS Management important? .....	3
9.1.4.2	WAVEMON Shutdown and Monitoring Software.....	3
9.1.5	SNMP CARD/ADAPTER For Network Management /Remote Monitoring.....	5

## 9.1 OPTIONS

### 9.1.1 Introduction

The **CONCEPTPOWER DPA™ S2** is provided with the following accessories:

- REMOTE SHUT DOWN FACILITIES
- GENERATOR ON FACILITIES
- 2 CUSTOMER IN FUNCTIONS (ON REQUEST)
- TEMPERATURE SENSOR FOR TEMP. DEPENDING BATTERY CHARGERING
- SOFTWARE FOR AUTOMATIC SHUTDOWN AND MONITORING
- SNMP INTERFACES FOR NETWORK MANAGEMENT AND REMOTE MONITORING

### 9.1.2 Remote SHUT DOWN

The REMOTE SHUT DOWN **must** use a normally closed contact, which opens to operate the remote shut down sequence.

The remote shutdown on terminal port X1/1.. X1/2 is located at the bottom of the **CONCEPTPOWER DPA™ S2** frame on communication card with terminal blocks X1 ...X4. See section 3 / 3.1.2.1 for details.

In order to allow removal, maintenance or testing of any remote shut down facility without disturbing the normal operation of the UPS, it is recommended that a terminal block, with linking facilities, be installed between the UPS and the stop button.

1. Use a screened cable with 1 pair (section of wires 0.5 mm<sup>2</sup>) and maximum length of 100 m.
2. Connect the cable as shown in Fig. 1.

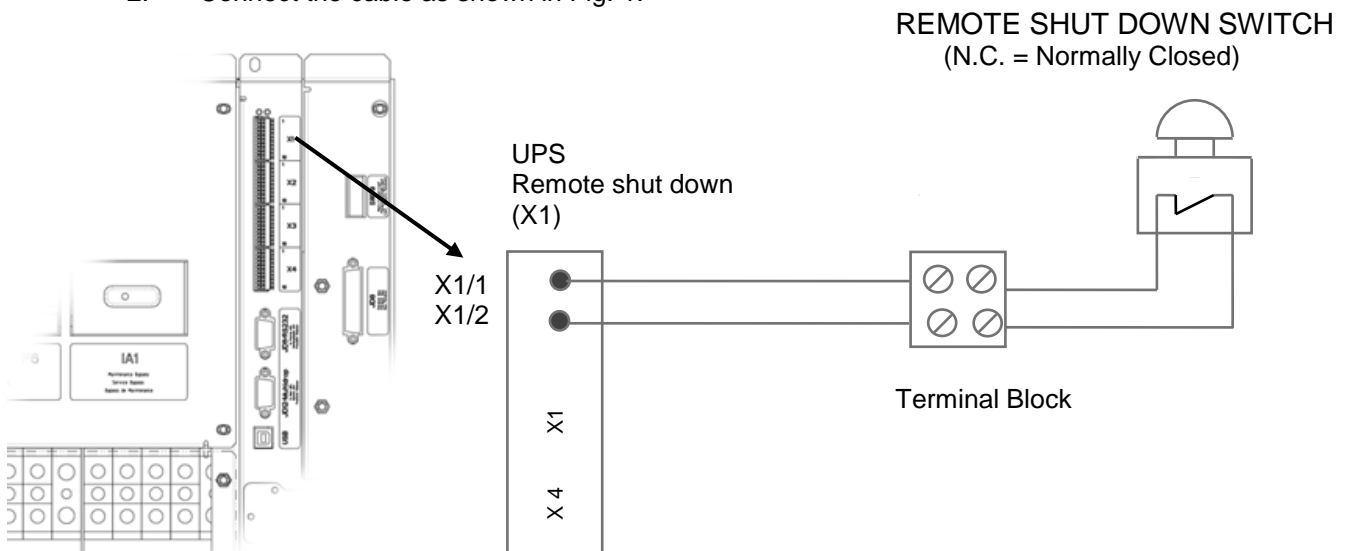

Fig 1. Drawing of the wiring for the REMOTE SHUT DOWN SWITCH.

### 9.1.3 Generator ON Facilities

The Generator ON facility must use a normally open contact that closes to indicate that a generator is running and supplying input power to UPS. It is located at the bottom of the **CONCEPTPOWER DPA™ S2** frame on communication card with terminal blocks X1 ...X4. See section 3 / 1.2.1 for details

When used, this facility disables the UPS static bypass and prevents the UPS from transferring the load onto the generator power supply.

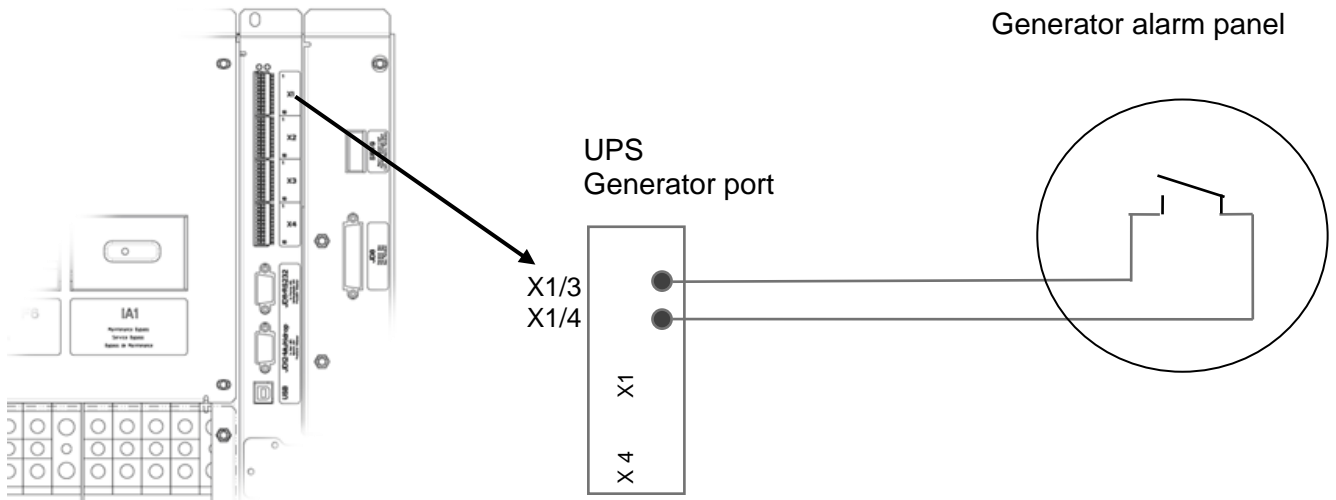

Figure 2. Generator ON Connection

### 9.1.4 Wavemon Shutdown and Management Software

#### 9.1.4.1 Why is UPS Management important?

By combining a UPS with network management products, such as an SNMP protocol, System-administrators are guaranteed their data and their system will constantly be protected from corruption or data loss even in the event of an extended power failure or when batteries reach a critical low state. In the event of a power disturbance system administrators can also monitor their network from a central location, allowing an early detection of problems. In fact utility power is unreliable at times, ensuring that all network systems have constant power can be a difficult task. The situation becomes even more complex if systems are managed across a Local Area Network (LAN) or Wide Area Network (WAN) around the world.

When a power failure occurs action can be taken to protect the system and its valuable data. If no action is initiated by the operator, this event can seriously damage the system. The UPS software will react automatically in such a case and shutdown the operating system. The manufacturer has found it important to have a complete solution for its UPS and is able to offer a wide range of monitoring/remote controls for assuring the maximum protection degree to the customers.

#### 9.1.4.2 WAVEMON Shutdown and Monitoring Software

**WAVEMON Software** is an external monitoring and shutdown software which was designed to operate with all UPS products, both with the DRY PORT (Relays) on Terminal block X2 ...X4 and RS232 port JD11 on the communication card

The software packet consists of a CD ROM for most diffused operating systems (Windows, Unix, OS/2, DEC VMS, Novell, Apple), a standard connection and a user manual.

The dry port X2...X4 with voltage-free contacts may also be used for automatic shutdown in connection with **WAVEMON Software**. It is necessary to provide a cable of 0.5 mm<sup>2</sup> to connect Terminals X2..X4 of the UPS and the serial port of the server.

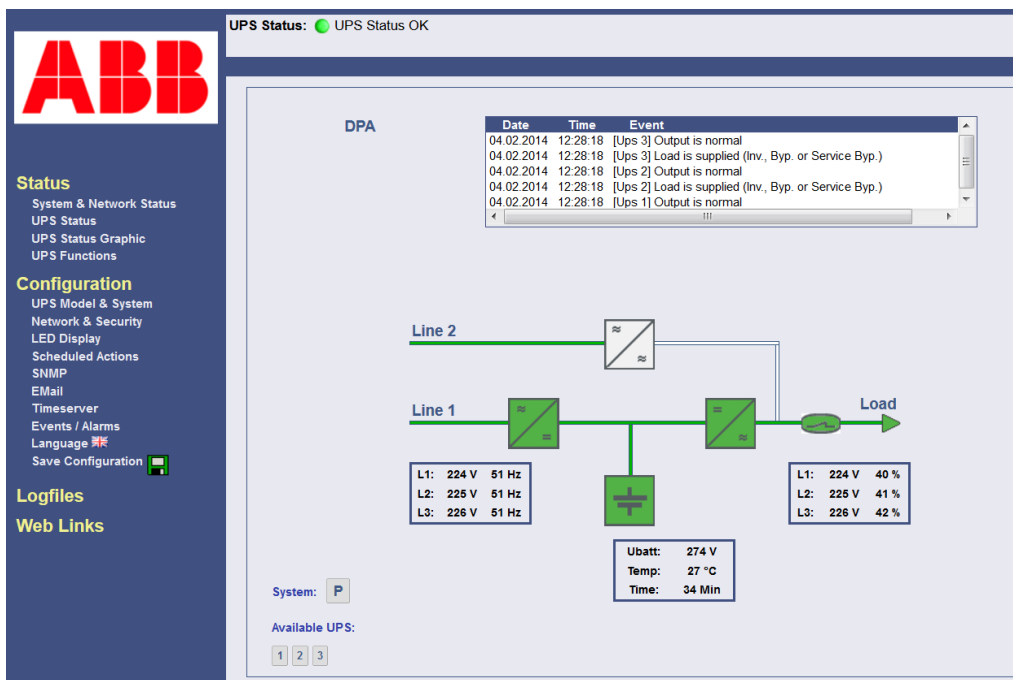

Figure 3. Monitoring image.

The main characteristics of **WAVEMON Software** are:

- Automatic unattended master/slave shutdown in heterogeneous networks
- On-screen autonomy time / battery time countdown
- On-screen server log off and shutdown procedure
- Extensive logging of all UPS activity and power quality data, with timestamp
- Scheduled UPS economy mode, service mode, other systems status
- Graphical user interface for Windows compatible platforms
- Automatic unattended local shutdown
- Special software modules to close and save open MS-Office documents.
- Compatible for all optional modules like UPSDIALER, SNMP adapters, Temperature sensors, etc.

The UPS-Management Software is a client-/server-application for networks and local workstations. Basically **WAVEMON-Software** consists of two parts: the server-module of the UPS-Management Software is **UPSServ**, which communicates via RS-232 cable with the UPS. Working as a background process the UPSServ collects messages, received from the UPS. The UPSServ interprets received messages and makes them available to the client-module **UPSCli** and to any SNMP-based management station.

When UPSServ detects voltage variations or a power failure it can execute various so called system „event routines“, which for example may shutdown the server or send warning to connected users. These system event routines which are a part of the UPS-Management Software can be adjusted to your demands.

The UPS management software includes with every serial number the licence for using the UPS service on one server with one UPS and an unlimited numbers of connected WINDOWS workstations. When operating with two or more servers a licence for every additional server is required. It doesn't matter if the UPS service runs at that location or if the server is halted by a UPS service via remote command. The same regulations are applicable to the use of remote send/receive modules RCCMD and multiserver shutdown under NT, UNIX and other operating systems. The service programs are generally delivered as a single-licence. To use a single CD ROM to shutdown multiple servers you have to purchase additional CD license keys.

Parallel/redundant UPS systems are also manageable by the software.

The main principle is: let introduce a shutdown of a Server only when strictly necessary. A correct Parallel Handling has therefore to manage a parallel system as a whole and always considering redundancy. Following statements apply:

- Every alarm on any unit is immediately notified, but ...
- ... a reaction to a severe fault is introduced only when the minimum number of UPS –Modules necessary to supply the load exhibits an alarming situation.
- The real Battery autonomy time of the (whole) parallel system is computed continuously.
- Maintenance on a redundant unit may be executed without annoyance to the management system (supervisor).

In order to be managed, a UPS can be integrated into a network in two ways:

1. By means of the server which is being powered by the UPS and is integrated in the network. In most of the cases the server is used as sub-agent and you only need the PMC-Software without any SNMP Adapter. You need a standard serial connection between the RS232 JD11 port of the UPS and the RS232 port of the computer/server.
2. In some situations it is preferable to interface the network via an SNMP adapter. By this way up to 50 computers can be shut down in a RCCMD environment. RCCMD (Remote Console Command) is an additional software module, which can be triggered by the SNMP device to executes a command (typically a shutdown command) on a remote system.

### 9.1.5 SNMP CARD/ADAPTER For Network Management /Remote Monitoring

The **Simple Network Management Protocol** (SNMP) is a worldwide-standardized communication-protocol. It is used to monitor any device in the network via simple control language. The UPS-Management Software also provides its data in this SNMP format with its internal software agent. The operating system you are using must support the SNMP protocol. We offer our software with SNMP functionality for Novell, OS/2, all Windows running on INTEL and ALPHA, DEC VMS, Apple.

Two types of SNMP interfaces with identical functionality are available: an external SNMP-Adapter (Box) and an internal SNMP-Card. Both can manage a parallel system (N modules) and return either global values - which are consistent for the whole parallel system - or specific values from the single modules.

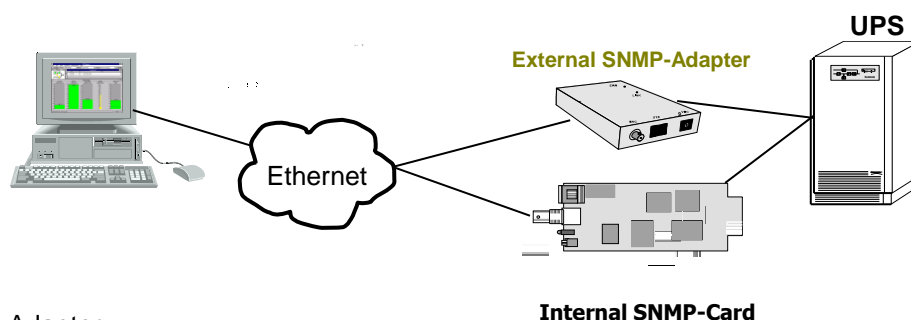

Figure 1.5 SNMP Adapter

The adapter may be configured via Telnet, HTTP (Web-Browser) or serial connection (Terminal). For normal operation at least one network connection (Ethernet) is required.

The SNMP adapter can be used, utilizing the RCCMD send function, for an automatic network wide shut down or just for informing connected users. The shut down procedure can be initiated on a low residual battery autonomy time (downtime) or by a countdown timer which is started at the beginning of the alarm. A shut down is therefore possible without extra input from the operator, and is fully software controlled.

The small (125x70 mm) External SNMP adapter comes with following interfaces:



1. RJ-45 connector for 10/100 Base-T (auto switchable)
2. Serial Port for configuration (COM2) or optional ModBus interface.
3. Error/Link LED for UPS status
4. Aux Port
5. DIP Switch
6. Serial Port to the UPS (COM1)
7. DC Supply (9 VDC or 9-36 VDC supply, depending on model);

Figure 1.5.1 External SNMP Adapter



The Internal SNMP-Card can be inserted into an appropriate extension slot of the **PMC**. This adapter communicates via the serial port of the UPS and makes a direct multiple server shut down possible without additional SNMP management software.

Figure 1.5.2 Internal SNMP Adapter

For detailed information please see Software Manual provided with the PMC-Software CD ROM. **RCCMD - Remote Console Command module** for a multi-server shutdown. This stand-alone software module is designed to receive and execute a command issued by a remote device. Thanks to RCCMD it is possible to execute a shutdown in an heterogeneous multiplatform network. The new release RCCMD2 is an application available for all Operating Systems, analogous to PMC-Software. Our SNMP Interfaces are compatible to RCCMD.

# Conceptpower DPA™ S2 30 - 250 kVA Technical Specifications



<b>TABLE OF CONTENTS</b>
--------------------------

<b>10.1</b>	<b>CONCEPTPOWER DPA SYSTEM DESCRIPTION</b> .....	<b>3</b>
<b>10.2</b>	<b>TECHNICAL CHARACTERISTICS</b> .....	<b>4</b>
10.2.1	MECHANICAL CHARACTERISTICS MX-FRAMES AND MODULES.....	4
10.2.2	POWER SELECTION TABLE CONCEPTPOWER DPA MODULES.....	5
<b>10.3</b>	<b>INPUT CHARACTERISTICS</b> .....	<b>5</b>
<b>10.4</b>	<b>BATTERY CHARACTERISTICS</b> .....	<b>6</b>
<b>10.5</b>	<b>OUTPUT CHARACTERISTICS</b> .....	<b>6</b>
10.5.1	GRAPH: AC – AC EFFICIENCY with Linear load @ cosphi 1 (**).....	7
10.5.2	GRAPH: Output Power in KW and KVA VERSUS cosphi.....	8
<b>10.6</b>	<b>ENVIRONMENTAL CHARACTERISTICS</b> .....	<b>9</b>
<b>10.7</b>	<b>STANDARDS</b> .....	<b>9</b>
<b>10.8</b>	<b>COMMUNICATION</b> .....	<b>10</b>
10.8.1	POWER MANAGEMENT DISPLAY (PMD).....	10
10.8.2	MIMIC DIAGRAM.....	10
10.8.3	DISPLAY.....	10
10.8.4	CUSTOMER INTERFACES (Terminals X1...X4).....	11
10.8.5	CUSTOMER INPUTS DRY PORT s: Terminal block X1.....	11
10.8.6	CUSTOMER OUTPUTS DRY PORTs : Terminal blocks X2, X3, X4.....	11
<b>10.9</b>	<b>OPTIONS</b> .....	<b>12</b>
10.9.1	SNMP card / WaveMon Management Software.....	12
10.9.2	BATTERY CABINETS.....	13
<b>10.10</b>	<b>BATTERY AUTONOMIES</b> .....	<b>14</b>
10.10.1	MX Modules: Examples of Internal Battery Autonomy.....	14
10.10.2	MX Modules: Examples of External Battery Autonomy.....	14
<b>10.11</b>	<b>INSTALLATION PLANNING</b> .....	<b>15</b>
10.11.1	HEAT DISSIPATION PER MODULE WITH NON-LINEAR LOAD.....	15
<b>10.12</b>	<b>WIRING AND BLOCK DIAGRAMS FOR ALL FRAMES AND MODULES</b> .....	<b>16</b>
10.12.1	TERMINAL CONNECTIONS OVERVIEW.....	16
10.12.2	SINGLE FEED INPUT.....	17
10.12.3	DUAL FEED INPUT.....	18



**10.1 CONCEPTPOWER DPA SYSTEM DESCRIPTION**

In environments that demand zero downtime, continuous power protection availability is essential. In order to respond to today’s dynamic IT and process-related environments that experience daily change through new server technologies, migration and centralization, resilient and easily adaptable power protection concepts are required. CONCEPTPOWER DPA is the foundation for continuous power protection availability of network-critical infrastructures in enterprise data centers where business continuity has paramount importance and in process control environment where manufacturing continuity is essential.

CONCEPTPOWER DPA’S is a second generation high-power-density (HPD), leading-edge double-conversion power protection technology that has standardized on a modular component approach which helps speed deployment, improve adaptability and increase system availability while reducing total cost of ownership.

CONCEPTPOWER DPA’S is a unique on-demand architecture that integrates the power rack, power distribution unit, back-up battery rack and monitoring and management solutions to allow easy selection of optimized configurations.

CONCEPTPOWER DPA’S (Distributed Parallel Architecture) provides highest availability, unmatched flexibility and at the same time lowest cost of ownership in IT environments.

This Technical Specification provides detailed technical information on the mechanical, electrical and environmental performance of the CONCEPTPOWER DPA that can support to give answers to tender and end-user requirements. The CONCEPTPOWER DPA was designed to respond to the most stringent safety, EMC and other important UPS standards.

CONCEPTPOWER DPA is a rack-mountable modular design. It offers 3-types of Racks (Frames) and 3 types of DPA-Modules to accommodate a wide range of power requirements.



The three MX-Frames; Classic DPA-50, Triple DPA-150, Upgrade DPA-250 can accommodate the three (3) MX-DPA-Modules types DPA 30 or 40 or 50 of: 30kVA/24kW - 40kVA/32kW - 50kVA/40kW power.

**Key Features of CONCEPTPOWER DPA S2 Modules :**

- Highest Availability  
Modular, Decentralized Parallel Architecture (DPA) *Near-zero down time*
- High Power Density (up to 342kW / m<sup>2</sup>),  
Small Footprint *Space-saving of expensive floor space*
- Blade-server-friendly power  
Full power from 0.9 lead to 0.8 lag *No de-rating with leading PF loads*
- High Efficiency even with partial loads  
Efficiency up to 95.5%  
(depending on Module power and type of load) *Energy cost saving during UPS-life-cycle*
- Very low input current distortion THDi  
THDi = < 3.0 % on 100 % loading *Gen-set power and installation cost saving*

**10.2 TECHNICAL CHARACTERISTICS**

**10.2.1 MECHANICAL CHARACTERISTICS MX-FRAMES AND MODULES**

CONCEPTPOWER DPA		CLASSIC DPA-50	TRIPLE DPA-150	UPGRADE DPA-250
<b>MX - FRAMES</b>				
Configuration accommodates:	Max.	1 module (30-50kVA) and 280 x 7/9Ah batteries	3 modules (30-50kVA) and 240x 7/9Ah batteries	5 modules (30-50kVA) and no batteries
Max. Power connection	kVA	50	150	250
Dimensions (WxHxD)	mm	730x1650x800	730x1975x800	730x1975x800
Weight of Empty Frame w/o modules and w/o batteries	kg	262	239	205
Weight of Frame with modules and w/o batteries	kg	305 up to 309 (with 1 Module)	368 up to 379 (with 3 Modules)	420 up to 439 (with 5 Modules)
Audible noise at 1m from front, 100% / 50% Load	dBA	70 / 63	74 / 67	76 / 69
Colours		Front door silver :RAL 9007 + black (inlets) Side walls/top: Graphite grey (Pulverlacke No. 4222903402 serie 09RCCAT1)		

MX- DPA MODULES		DPA 30 S2	DPA 40 S2	DPA 50 S2
Output Apparent Rated Power	KVA	30	40	50
Output Active Rated Power	KW	24	32	40
Output Power with Load PF=1	KVA / KW	24 / 24	32 / 32	40 / 40
Dimensions (WxHxD)	mm	663 x 225 x 720		
Weight UPS Module	kg	43.1	45.3	46.8
Colours		Front : Graphite grey (Pulverlacke No. 4222903402 serie 09RCCAT1)		

10.2.2 POWER SELECTION TABLE CONCEPTPOWER DPA MODULES

Concept Power DPA: Power Modules DPA 30 - DPA 50

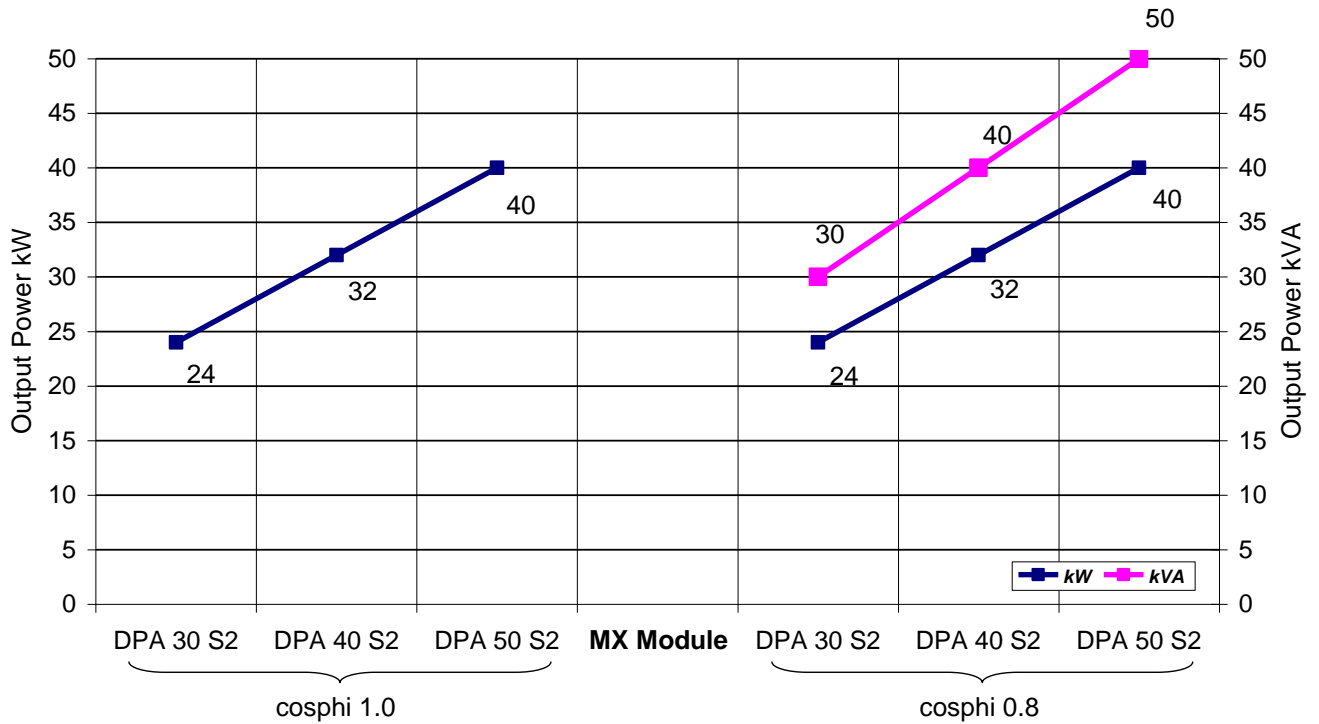

10.3 INPUT CHARACTERISTICS

Module type	unit	DPA 30 S2	DPA 40 S2	DPA 50 S2
Output Rated Power per Module cosφ 0.8	kVA	30	40	50
Output Rated Power per Module cosφ 1.0	KW	24	32	40
Nominal Input Voltage	V	3x380/220V+N, 3x400V/230V+N, 3x415/240V+N		
Input Voltage Tolerance (ref to 3x400/230V) for Loads in %:	V	(-20%/+15%) 3x308/184 V to 3x460/264 V for <100 % load (-26%/+15%) 3x280/170 V to 3x460/264 V for < 80 % load (-35%/+15%) 3x240/150 V to 3x460/264 V for <60 % load		
Input Frequency	Hz	30 - 70		
Input Power Factor		PF=0.99 @ 100 % load		
Inrush Current	A	limited by soft start / max. In		
Input Distortion THDI		= < 3.0 % @ 100% load		
Max. input power with rated output power (cosphi = 1.0), rated input voltage and charged battery <b>per Module</b>	kW	25.5	34.0	42.6
Max. Input Current with rated output power (cosphi = 1.0), rated input voltage and charged battery <b>per Module</b>	A	36.8	49.1	62.1
Max. Input Power with rated output power (cosphi = 1.0), rated input voltage and discharged battery <b>per Module</b> 8A charger (optional 15 charger)	kW	27.8 (28.1)	36.3 (37.4)	44.9 (46.0)
Max. Input Current with rated output power (cosphi = 1.0), rated input voltage and discharged battery <b>per Module</b> 8A charger (optional 15 charger)	A	40.3 (40.7)	52.6 (54.2)	65.1 (66.7)

### 10.4 BATTERY CHARACTERISTICS

Module type	unit	DPA 30 S2	DPA 40 S2	DPA 50 S2
Allowed number of 12V Battery Blocks / 1.2V NiCd cells Depending on the UPS room temperature	-	40 - 50 blocks / 420 – 500 cells at < 25°C 42 - 50 blocks / 420 – 500 cells at < 30°C 44 - 50 blocks / 440 – 500 cells at < 35°C 46 - 50 blocks / 480 – 500 cells at < 40°C		
Maximum Battery Charger Current	A	8A (15A on request)		
Battery Charging Curve		Ripple free ; IU (DIN 41773)		
Temperature compensation		Standard (temp. sensor optional)		
Battery Test		Automatic and periodically (adjustable)		
Battery Type		Maintenance free VRLA or NiCd		

### 10.5 OUTPUT CHARACTERISTICS

Module type	unit	DPA 30 S2	DPA 40 S2	DPA 50 S2
Output Rated Power per Module	kVA	30	40	50 <sup>1)</sup>
Output Rated Power per Module	KW	24	32	40
Output Current In @ cosphi 1.0 (400 V)	A	35	46.5	58
Output Rated Voltage	V	3x380/220V or 3x400/230V or 3x415/240V		
Output Voltage Stability	%	Static:		< ± 1%
		Dynamic (Step load 0%-100% or 100%-0%)		< ± 4%
Output Voltage Distortion	%	With Linear Load		< 2%
		With Non-linear Load (EN62040-3)		< 4%
Output Frequency	Hz	50 Hz or 60 Hz		
Output Frequency Tolerance	%	Synchronized with mains		< ± 2 %
		(selectable for bypass operation)		or < ± 4 %
		Free running		± 0.1 %
Bypass operation		At Nominal Input voltage of 3x400 V +/- 15% or 196 V to 264 V ph-N		
Permissible Unbalanced Load (All 3 phases regulated independently)	%	100%		
Phase Angle Tolerance (With 100 % Unbalanced load)	Deg.	± 0 deg.		
Overload Capability on Inverter	%	125 % load		10 min.
		150 % load		60 sec.
Output short capability on inverter	A (r.m.s.)	2.2 – 2.4 x In for 40 ms		
Output short capability on static bypass	A (r.m.s.)	10 x In for 10 ms		
Crest – Factor (Load supported)		3:1		

<sup>1)</sup> **Note:** The bypass rated current is 63A with the following overload capabilities:  
110% continuously, 125% for 60 minutes and 150% for 30 minutes.

10.5.1 GRAPH: AC – AC EFFICIENCY with Linear load @ cosphi 1 (\*\*)

Details refer to paragraph 10.6 Environmental Characteristics

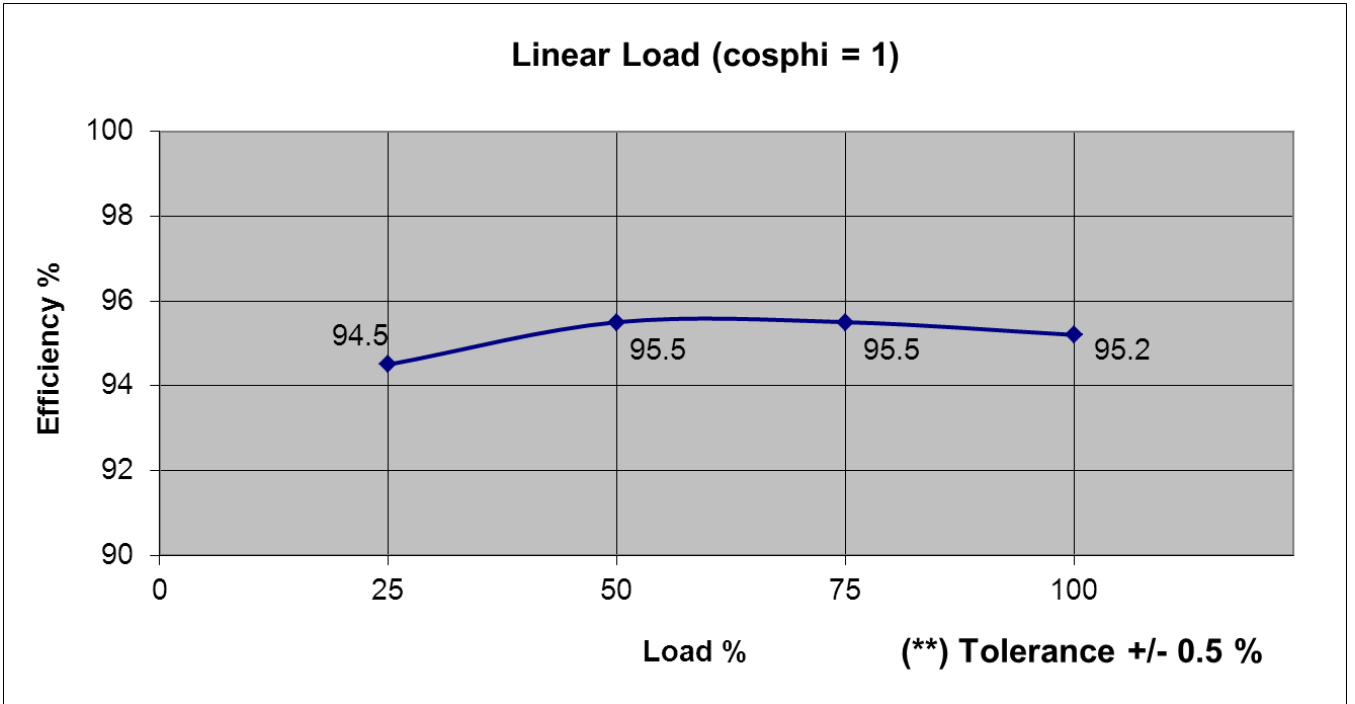

10.5.2 GRAPH: Output Power in KW and KVA VERSUS cosphi

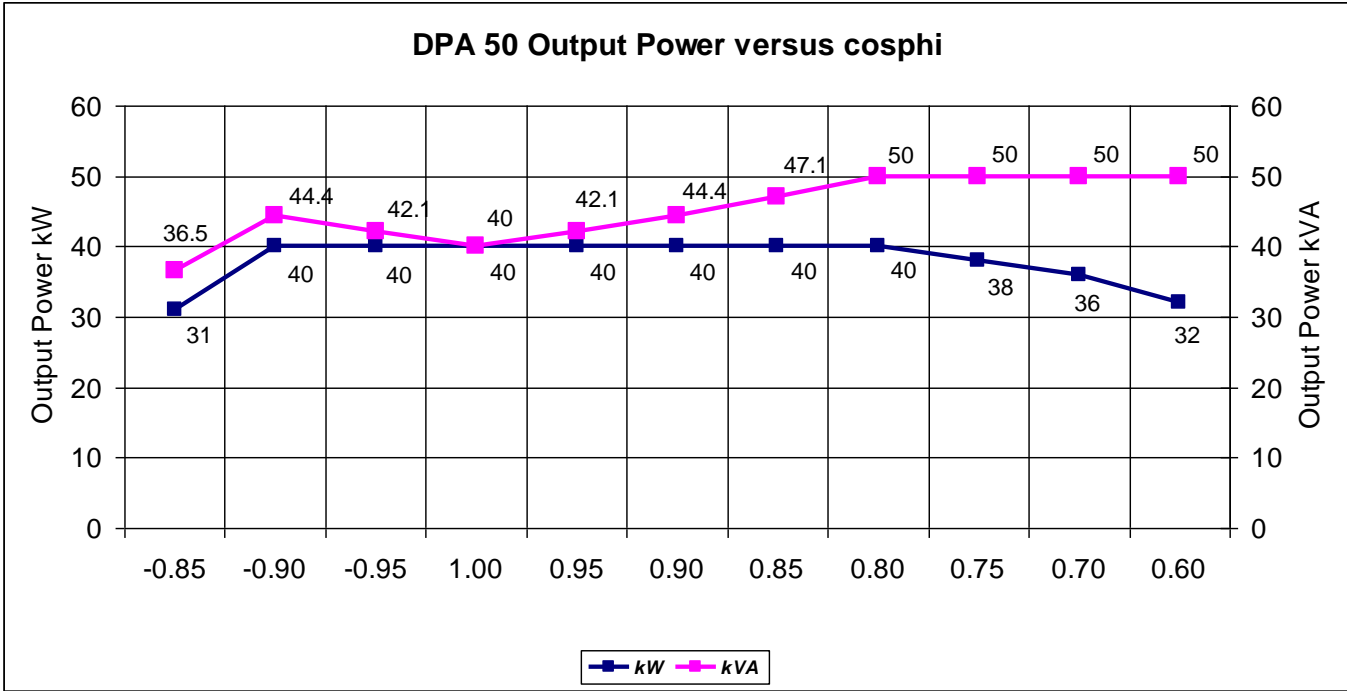

	cosφ	MX Module Range					
		DPA30 S2		DPA40 S2		DPA50 S2	
		kW	kVA	kW	kVA	kW	kVA
Cap.	0.85	18.5	21.8	24.6	29	31	36.5
	0.90	24	26.7	32	35.6	40	44.4
	0.95	24	25.3	32	33.7	40	42.1
	1.00	24	24	32	32	40	40
	0.95	24	25.3	32	33.7	40	42.1
Ind.	0.90	24	26.7	32	35.6	40	44.4
	0.85	24	28.2	32	37.6	40	47.1
	0.80	24	30	32	40	40	50
	0.75	22.9	30	30.5	40	38	50
	0.70	21.7	30	28.9	40	36	50
	0.60	19	30	25.4	40	32	50

Changes of this table without notice – modifications reserved

**10.6 ENVIRONMENTAL CHARACTERISTICS**

Module Range		MX				
Module Type		DPA 30 S2	DPA 40 S2	DPA 50 S2		
Operation temperature	°C	0 – 40				
Ambient Temperature for Batteries (recommended)	°C	20 – 25				
Storage Temperature	°C	-25 – +70				
Battery Storage Time at Ambient Temperature		Max. 6 months				
Max. altitude (above sea level)	m	1000m (3300ft) without de-rating				
De-rating factor for use at altitudes above 1000m sea level according ( IEC 62040-3)		Meter above sea level (m / ft)	De-Rating Factor for Power			
		1500 / 4850	0.95			
		2000 / 6600	0.91			
		2500 / 8250	0.86			
3000 / 9900	0.82					
Relative Air-humidity		Max. 95% (non-condensing)				
Accessibility		Totally front accessibility for service and maintenance (no need for side, top or rear access)				
Positioning		Min. 20 cm rear space (required for fan)				
Input and Output Power Cabling		From the bottom on the front				
Efficiency AC-AC up to (at cosphi 1.0) (depending on Module power)	%	Load :	100%	75%	50%	25%
		DPA 30-50:	95.2%	95.5%	95.5%	94.5%
Efficiency Non-linear Load (EN 62040-1-1:2003)		Typically up to 1 % lower of above values				
Eco-Mode efficiency at 100% load	%	98%				

**10.7 STANDARDS**

Safety	Product Standards IEC/EN 62040-1		Standards IEC/EN 60950-1		
Electromagnetic Compatibility	Product Standards IEC/EN 62040-2		Standards IEC/EN 61000-6-2 ; IEC/EN 61000-6-4 IEC/EN 61000-4-2 ; IEC/EN 61000-4-3 IEC/EN 61000-4-4 ; IEC/EN 61000-4-5 IEC/EN 61000-4-6		
EMC Classification	DPA-30	DPA-40	DPA-50		
Emission Class	C3	C3	C3		
Immunity Class	C3	C3	C3		
Performance	IEC/EN 62040-3				
Product certification	CE				
Degree of protection	IP 20				

**10.8 COMMUNICATION**

Power Management Display (PMD)	1 LCD display for each module
Serial ports RS232 on Sub-D9	2x system frame + 1x on each module (Smart Port) For monitoring and integration in network management
USB	1x For monitoring and software management
Customer Interfaces : Inputs DRY PORT X1	1 Remote Shut down [EMERGENCY OFF (Normally closed)] 1 GEN-ON (Normally open) 2 Programmable Customer's Inputs (Normally open) 1 Temp. Sensor for Battery Control
Customer Interfaces : Outputs DRY PORT X2 , X3, X4	10 voltage free contacts For remote signalling and automatic computer shutdown
Slot for SNMP	SNMP card (optional) For monitoring and integration in network management

**10.8.1 POWER MANAGEMENT DISPLAY (PMD)**

The user-friendly PMD consists of three parts the MIMIC DIAGRAM, CONTROL KEYS and LCD that provides the necessary monitoring information about the UPS.

**10.8.2 MIMIC DIAGRAM**

The mimic diagram serves to give the general status of the UPS. The LED-indicators show the power flow status and in the event of mains failure or load transfer from inverter to bypass and vice-versa the corresponding LED-indicators will change colour from green (normal) to red (warning). The LED's LINE 1 (rectifier) and LINE 2 (bypass) indicate the availability of the mains power supply. The LED's INVERTER and BYPASS if green indicate which of the two are supplying power to the critical load. When the LED-indicator BATTERY is lit it means that the battery due to mains failure is supplying the load. The LED-indicator ALARM is a visual indication of any internal or external alarm condition. At the same time the audible alarm will be activated.

**10.8.3 DISPLAY**

The 2 x 20 character LCD simplifies the communication with the UPS. The menu driven LCD enables the access to the EVENT REGISTER, or to monitor the input and output U, I, f, P, Autonomy Time and other Measurement's, to perform commands like start-up and shut-down of INVERTER or load transfer from INVERTER to BYPASS and vice-versa and finally it serves for the DIAGNOSIS (SERVICE MODE) for adjustments and testing (for more details see the USER MANUAL of Conceptpower DPA™ S2).

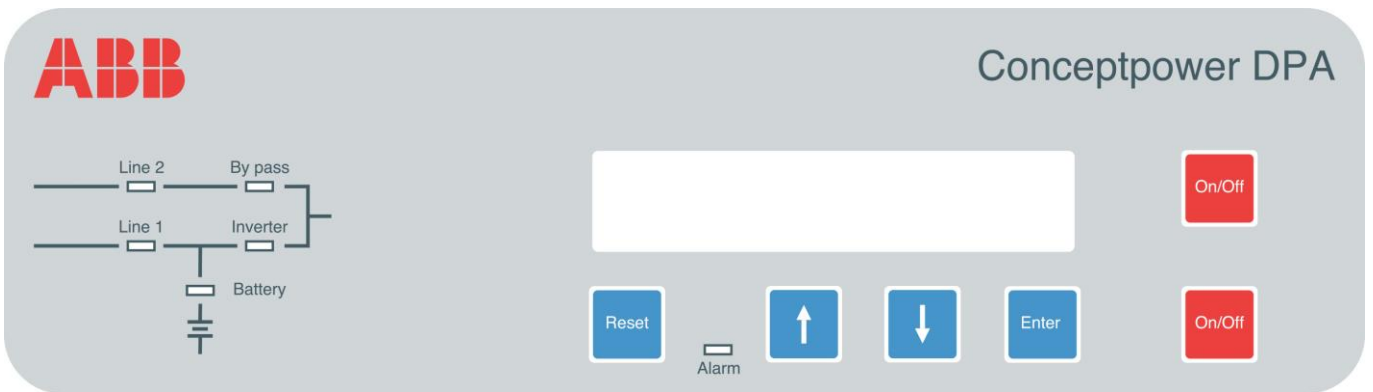

Power Management Display (PMD) of Conceptpower DPM™ S2



**10.8.4 CUSTOMER INTERFACES (Terminals X1...X4)**

**10.8.5 CUSTOMER INPUTS DRY PORT s: Terminal block X1**

Connection of Remote Shut down facilities, Generator Operation, Customers specials  
(see UM Section 9 / OPTIONS)

**10.8.6 CUSTOMER OUTPUTS DRY PORTs : Terminal blocks X2, X3, X4**

Provision of signals for the automatic and orderly shutdown of servers, AS400 or Automation building systems  
All voltage free contacts are rated 60 VAC max. and 500 mA max.:  
All the interfaces are connected to Phoenix Spring terminals with wires : 0.5 mm2

Block	Terminal	Contact	Signal	On Display	Function
X1	X1 / 1		+ 3.3 Vdc		<b>Remote Shut down</b>
	X1 / 2		GND		(Do not remove the factory mounted bridge until external Remote Shut down is connected)
	X1 / 3		+ 3.3 Vdc		<b>Generator Operation</b>
	X1 / 4		GND		(NC = Generator ON)
	X1 / 5		+ 3.3 Vdc		<b>Customer IN 1</b>
	X1 / 6		GND		(Function on request, to be defined)
	X1 / 7		+ 3.3 Vdc		<b>Customer IN 2</b>
	X1 / 8		GND		(Function on request, to be defined)
	X1 / 9		+ 3.3 Vdc		<b>Temperature Battery</b>
	X1 / 10		GND		(If connected , the battery charger current if depending of the battery temp.)
X2	X2 / 1		ALARM	MAINS_OK	Mains Present
	X2 / 2				<b>Mains Failure</b>
	X2 / 3				Common
	X2 / 4		Message	LOAD_ON_INV	<b>Load on Inverter</b>
	X2 / 5				(Load on Mains bypass)
	X2 / 6				Common
	X2 / 7		ALARM	BATT_LOW	<b>Battery Low</b>
	X2 / 8				Battery OK
	X2 / 9				Common
	X3	X2 / 10		Message	LOAD_ON_MAINS
X3 / 1					(Load on Inverter)
X3 / 2					Common
X3 / 3			ALARM	COMMON_ALARM	<b>Common Alarm (System)</b>
X3 / 4					NO Alarm Condition
X3 / 5					Common
X3 / 6			ALARM	MODUL_ALARM1	<b>Module 1 Alarm</b>
X3 / 7					NO Alarm Condition
X3 / 8					Common
X3 / 9			ALARM	MODUL_ALARM2	<b>Module 2 Alarm</b>
X3 / 10				NO Alarm Condition	
X4 / 1				Common	
X4	X4 / 2		ALARM	MODUL_ALARM3	<b>Module 3 Alarm</b>
	X4 / 3				NO Alarm Condition
	X4 / 4				Common
	X4 / 5		ALARM	MODUL_ALARM4	<b>Module 4 Alarm</b>
	X4 / 6				NO Alarm Condition
	X4 / 7				Common
	X4 / 8		ALARM	MODUL_ALARM5	<b>Module 5 Alarm</b>
	X4 / 9				NO Alarm Condition
	X4 / 10				Common

Phoenix Spring Terminals (X1...X4) Connection

## 10.9 OPTIONS

- SNMP card and WaveMon Management Software , Modbus Protocol
- External Battery Cabinets
- Parallel bus for additional frames
- In/Output Transformator for special voltages
- Temp. sensor for battery temp. control

### 10.9.1 SNMP card / WaveMon Management Software

The Simple Network Management Protocol (SNMP) is a worldwide-standardized communication-protocol. It is used to monitor any device in the network via simple control language. The UPS-Management Software WaveMon also provides its data in this SNMP format with its internal software agent. The operating system you are using must support the SNMP protocol. We offer our WaveMon software with SNMP functionality for Novell, OS/2, all Windows running on INTEL and ALPHA, DEC VMS, Apple.

Two types of SNMP interfaces with identical functionality are available: an external SNMP-Adapter (Box) and an internal SNMP-Card. Both can manage a parallel system (N modules) and return either global values - which are consistent for the whole parallel system - or specific values from the single modules.

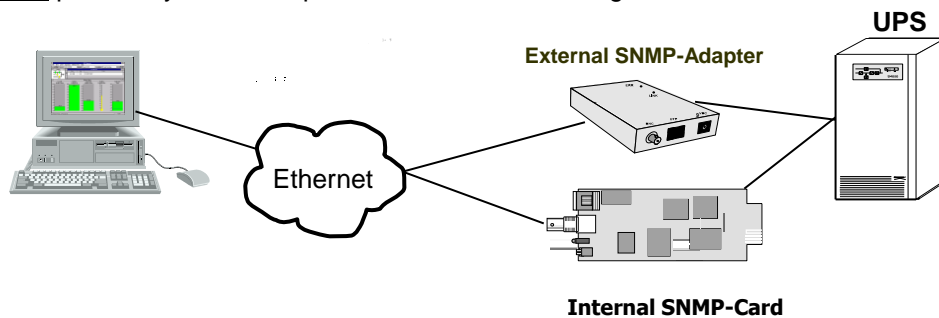

## 10.9.2 BATTERY CABINETS

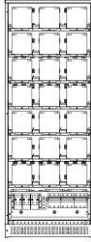
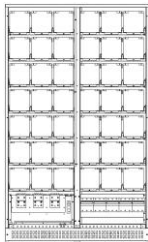
S-type = For Separate. Battery C-type = For Common. Battery		<b>CBAT-DPA-120</b> S-type or C-type	<b>CBAT-DPA-200</b> S-type or C-type
<b>BATTERY FRAMES</b>			
Configuration accommodates:	Max.	120 Batt. block x 24Ah/28Ah on 8 shelf 3x5=15 blocks/shelf	200 Batt. blocks x 24Ah/28Ah on 7 shelf 6x5=30 blocks/shelf
Battery fuses / Max. Batt. Strings : Terminals :	S-type	3 / 3 (Terminal 9 x 16/25mm <sup>2</sup> )	5 / 5 (Terminal 15 x 16/25mm <sup>2</sup> )
Battery fuses / Max. Batt. Strings Terminals :	C-type	3 / 3 + Com. Connection Bar 3 x (2xM8) +PE 2xM8	5 / 5 + Com. Connection Bar 3 x (2xM10) +PE 2xM10
Fuse Type (Very Fast acting)	A	3x100 A	5x100A
Dimensions (WxHxD)	mm	730x1975x800	1200x1975x800
Weight with trays and w/o batteries	kg	290	410
Possible Battery configurations within the Battery Cabinets		Battery Configurations 30x28Ah 40x28Ah 50x28Ah (2x30)x28Ah (2x40)x28Ah (2x50)x28Ah (3x30)x28Ah (3x40)x28Ah	Battery Configurations (2x40)x28Ah (3x40)x28Ah (4x40)x28Ah (5x40)x28Ah (2x50)x28Ah (3x50)x28Ah (4x50)x28Ah (5x30)x28Ah (5x40)x28Ah

## 10.10 BATTERY AUTONOMIES

### 10.10.1 MX Modules: Examples of Internal Battery Autonomy

<i>Module Type</i>		<i>DPA 30</i>	<i>DPA 40</i>	<i>DPA 50</i>
<b>Separate Battery configuration</b>		<b>Battery Autonomy in (min.) per Module</b>		
<b>Frame Type</b>	<b>Battery / Module</b> (up to 3 modules / within Triple-150 frame)	<b>30kVA/24KW</b>	<b>40kVA/32KW</b>	<b>50kVA/40KW</b>
CLASSIC DPA-50 or TRIPLE DPA-150	(2x40)x9Ah	8	6	
<b>Common Battery configuration</b>		<b>Battery Autonomy in (min.) for Tot. System Power</b>		
<b>With 1 Module</b>	<b>Module Type</b>	<b>1 x DPA 30</b>	<b>1 x DPA 40</b>	<b>1 x DPA 50</b>
	<b>Total System Power</b>	<b>30kVA/24KW</b>	<b>40kVA/32KW</b>	<b>50kVA/40KW</b>
CLASSIC DPA-50	(2x50)x9Ah	11	8	
CLASSIC DPA-50	(3x40)x9Ah	14	9	
CLASSIC DPA-50	(3x50)x9Ah	18	13	9
CLASSIC DPA-50	(4x50)x9Ah	26	18	14
CLASSIC DPA-50	(5x50)x9Ah	34	24	18
<b>With 2 Modules</b>	<b>Module Type</b>	<b>2 x DPA 30</b>	<b>2 x DPA 40</b>	<b>2 x DPA 50</b>
	<b>Total System Power</b>	<b>60kVA/48KW</b>	<b>80kVA/64KW</b>	<b>100kVA/80KW</b>
TRIPLE DPA-150	2x(2x40)x9Ah	8		
TRIPLE DPA-150	3x(2x40)x9Ah	14	9	7
<b>With 3 Modules</b>	<b>Module Type</b>	<b>3 x DPA 30</b>	<b>3 x DPA 40</b>	<b>3 x DPA 50</b>
	<b>Total System Power</b>	<b>90kVA/72KW</b>	<b>120kVA/96KW</b>	<b>150kVA/120KW</b>
TRIPLE DPA-150	3x(2x40)x9Ah	8	6	

### 10.10.2 MX Modules: Examples of External Battery Autonomy

This configuration are mostly used in combination with the frame UPGRADE DPA-250

<i>Module Type</i>		<i>DPA 30</i>	<i>DPA 40</i>	<i>DPA 50</i>
<b>Separate Battery configuration</b>		<b>Battery Autonomy in (min.) per Module</b>		
<b>Battery Cabinet</b> (for up to 5 modules linked)	<b>Battery / Module</b>	<b>30kVA/24KW</b>	<b>40kVA/32KW</b>	<b>50kVA/40KW</b>
1x CBAT-DPA-200	40x28Ah	13	9	7
<b>Common Battery configuration</b>		<b>Battery Autonomy in (min.) for Tot. System Power (4+1)</b>		
<b>With 4 Modules</b>	<b>Module Type</b>	<b>4 x DPA 30</b>	<b>4 x DPA 40</b>	<b>4 x DPA 50</b>
	<b>Total System Power</b>	<b>120kVA/96KW</b>	<b>160kVA/128KW</b>	<b>200kVA/160KW</b>
1x CBAT-DPA-120	(3x40)x28Ah	9	6	
1x CBAT-DPA-200	(3x50)x28Ah	12	9	
1x CBAT-DPA-200	(4X50)x28Ah	18	12	9
2x CBAT-DPA-200	5x (2x40) x 28Ah	43	30	22

**10.11 INSTALLATION PLANNING**

Clearances needed to allow proper airflow on the UPS system and to allow door opening.

Minimum clearances for single UPS				
UPS Model	A <sub>1</sub> (mm)	B <sub>1</sub> (mm)	C (°)	D (mm)
All (50, 150 and 250)	200	1000	115°	400

Minimum clearances for UPS + other cabinets in row				
UPS Model	A <sub>2</sub> (mm)	B <sub>2</sub> (mm)	C (°)	D (mm)
All (50, 150 and 250)	300	1000	115°	400

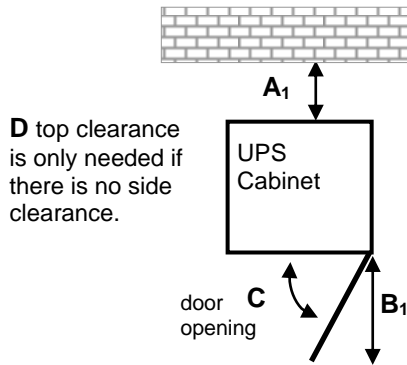

Figure 1: top view and indication of the minimum clearances for single UPS.

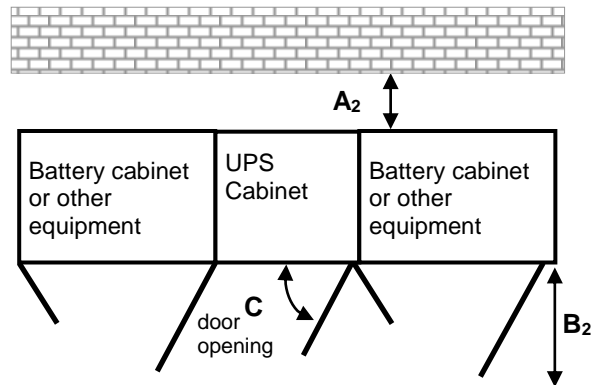

Figure 2: top view and indication of the minimum clearances for UPS + other cabinets in row .

UPS Frame type (50kVA up to 250 kVA)	CLASSIC DPA-50	TRIPLE DPA-150	UPGRADE DPA-250
Dimensions (WxHxD) mm	730x1650x800	730x1975x780	730x1975x800
<b>Battery Cabinet Type</b>	NA	<b>CBAT DPA-120</b>	<b>CBAT DPA-200</b>
Dimensions (WxHxD) mm	NA	730x1975x800	1200x1975x800
Accessibility	Totally front accessibility for service and maintenance (no need for side, top or rear access)		
Positioning	see chapter 10.11		
Input and Output Cabling	From the bottom on the front		

**10.11.1 HEAT DISSIPATION PER MODULE WITH NON-LINEAR LOAD**

Module Range		MX		
Module Type		DPA 30 S2	DPA 40 S2	DPA 50 S2
Heat Dissipation with 100% Non-linear Load per Module (EN 62040-1-1)	W	1532	2043	2553
Heat Dissipation with 100% Non-linear Load per Module (EN 62040-1-1)	BTU	5227	6969	8712
Airflow (25° - 30°C) with Non-linear Load per Module (EN 62040-1-1)	m <sup>3</sup> /h	380	380	380

**10.12 WIRING AND BLOCK DIAGRAMS FOR ALL FRAMES AND MODULES**

The customer has to supply the wiring to connect the UPS to the local power source. The installation inspection and initial start up of the UPS and extra battery cabinet must be carried out by a qualified service personnel such as a licensed service engineer from the manufacturer or from an agent certified by the manufacturer. More details and procedure are mentioned in the user manual.

**10.12.1 TERMINAL CONNECTIONS OVERVIEW**

FRAME TYPE Terminals (T) Connection Bar (B)	Separate. Battery (+ / N / - ) +PE	Common Battery (+ / N / - ) +PE	Input Bypass 3+N	Input Rectifier 3+N+PE	Output load 3+N+PE
<b>CLASSIC DPA-50</b>	3+1 x 16/25mm <sup>2</sup> (T)	3+1 x 16/25mm <sup>2</sup> (T)	4 x 16/25mm <sup>2</sup> (T)	5 x 16/25mm <sup>2</sup> (T)	5 x 16/25mm <sup>2</sup> (T)
<b>TRIPLE DPA-150</b>	9+1 x 16/25mm <sup>2</sup> (T) +PE 1xM10 (B)	3 x M10 (B) +PE 1xM10 (B)	3 x M10(B) +PE 1xM10 (B)	4 x M10 (B) +PE 1xM10 (B)	4 x M10 (B) +PE 1xM10 (B)
<b>UPGRADE DPA-250</b>	15 x 16/25mm <sup>2</sup> (T) +PE 1xM12 (B)	3 x M12 (B) +PE 1xM12 (B)	3 x M12 (B) +PE 1xM12 (B)	4 x M12 (B) +PE 1xM12 (B)	4 x M12 (B) +PE 1xM12 (B)

**CLASSIC DPA-50**

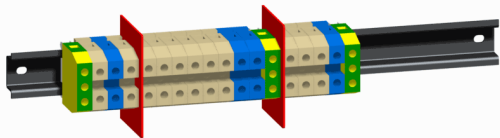

**TRIPLE DPA-150**



**UPGRADE DPA-250**

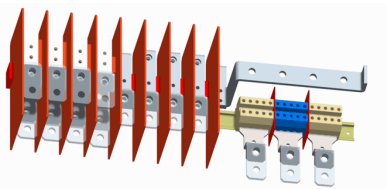

**Dual feed input**

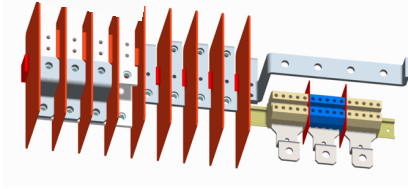

**Single feed input**

10.12.2 SINGLE FEED INPUT

Cable Sections and Fuse Ratings recommended. Alternatively, local standards to be respected

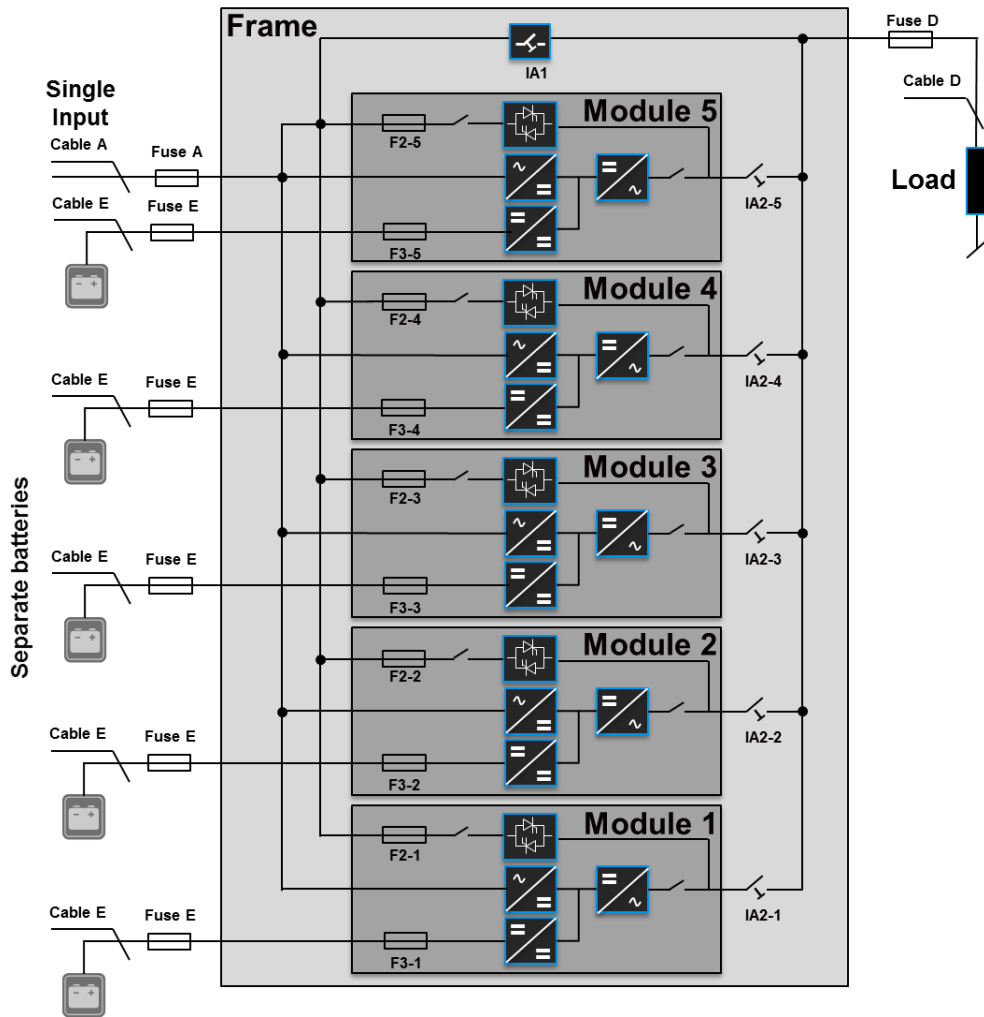

Frame type	Load kVA cosphi 0.8	Input 3x400V			Output 3x400V cosphi 0.8			Battery	
		Fuse A (AgI/CB)	Cable A (mm <sup>2</sup> ) (IEC 60950-1)	Max. Input Current with battery charging (A)	Cable D (mm <sup>2</sup> ) (IEC 60950-1)	I nom (A)	Fuse E + / N / - (AgI/CB)	Cable E (mm <sup>2</sup> ) for CBAT DPA 120 or 200 ONLY + / N / -	
								Com. Battery	Sep. Battery
<b>MX Frames (Frames shall be cabled to their full rating capability)</b>									
CLASSIC DPA 50	50	3x100A	5x25	67	5x25	72 A	3x100A*1	3x25	3x25
TRIPLE DPA-150	150	3x250A	5x120 or 5x(2x50)	202	5x120 or 5x(2x50)	218 A	3x300A*1	3x150	3x (3x25)
UPGRADE DPA-250	250	3x400A	5x(2x95)	337	5x(2x95)	362 A	3x500A*1	3x(2x150)	5x (3x25)
<b>Other intermediate Ratings (we recommend to cable the frame mentioned above at full rating to able future upgrading)</b>									
	30	3x63A	5x10	40	5x10	43 A	3x80A	3x16	
	40	3x80A	5x25	54	5x25	58 A	3x100A*	3x25*	
	45	3x100A	5x25	68	5x25	65 A	3x125A*	3x35*	
	60	3x100A	5x25	81	5x25	87 A	3x125A*	3x35*	
	80	3x125A	5x50	108	5x50	116 A	3x160A*	3x50*	
	90	3x160A	5x50	121	5x50	130 A	3x200A*	3x70*	
	100	3x160A	5x50	135	5x50	145 A	3x224A*	3x95*	
	120	3x200A	5x70	161	5x70	174 A	3x250A*	3x120*	
	160	3x250A	5x120 or 5x(2x50)	215	5x120 or 5x(2x50)	232 A	3x350A*	3x(2x70)*	
	200	3x315A	5x185 or 5x(2x70)	267	5x185 or 5x(2x70)	290 A	3x450A*	3x(2x95)*	

\*1 only valid for common battery use

10.12.3 DUAL FEED INPUT

Cable Sections and Fuse Ratings recommended. Alternatively, local standards to be respected

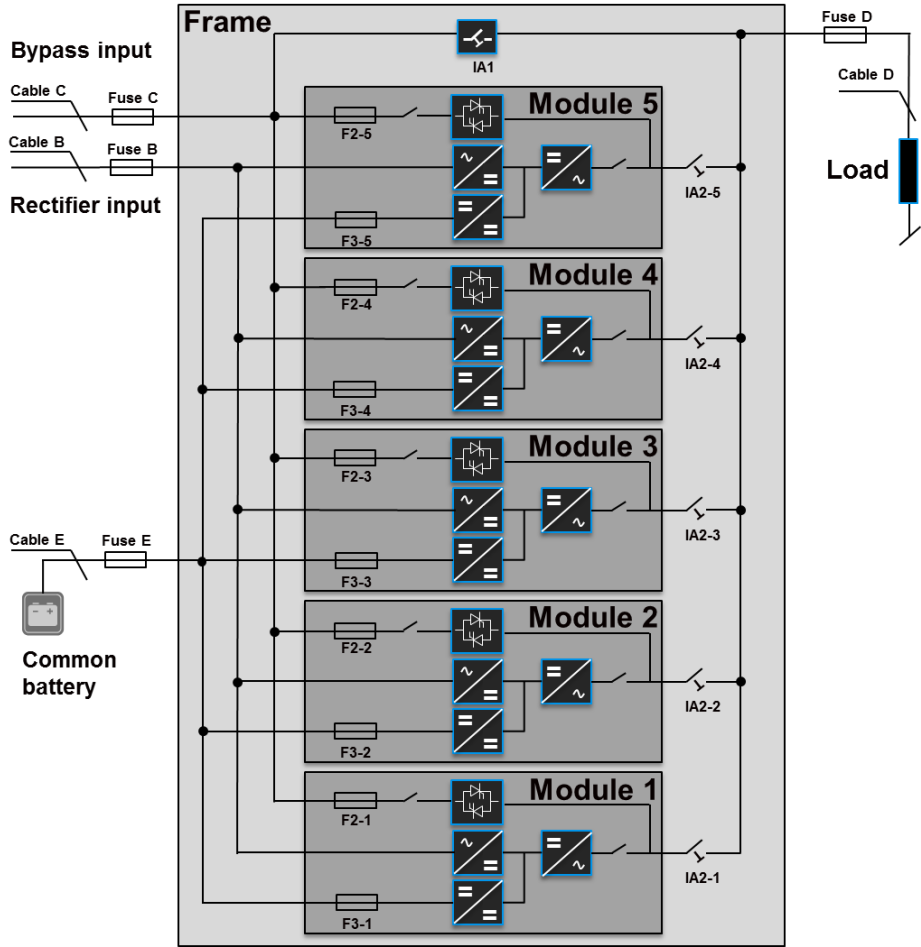

Frame type	Load kVA cosphi 0.8	Input 3x400V			Bypass 3x400V		Output 3x400V cosphi 0.8		Battery		
		Fuse B (Agl/CB)	Cable B (mm <sup>2</sup> ) (IEC 60950-1)	Max. Input Current with battery charging (A)	Fuse C (Agl/CB)	Cable C (mm <sup>2</sup> ) (IEC 60950-1)	Cable D (mm <sup>2</sup> ) (IEC 60950-1)	I nom	Fuse E +/N/- (Agl/CB)	Cable E (mm <sup>2</sup> ) for CBAT DPA 120 or 200 ONLY + / N / -	
MX Frames (Frames shall be cabled to their full rating capability)											
CLASSIC DPA 50	50	3x100A	5x25	67	3x100A	4x25	5x25	72 A	3x100A*1	3x25	3x25
TRIPLE DPA-150	150	3x250A	5x120 or 5x(2x50)	202	3x250A	4x120 or 4x(2x50)	5x120 or 5x(2x50)	218 A	3x300A*1	3x150	3x(3x25)
UPGRADE DPA-250	250	3x400A	5x(2x95)	337	3x400A	4x(2x95)	5x(2x95)	362 A	3x500A*1	3x(2x150)	5x(3x25)
Other intermediate Ratings (we recommend to cable the frame mentioned above at full rating to able future upgrading)											
	30	3x63A	5x10	40	3x63A	4x10	5x10	43 A	3x80A	3x16	
	40	3x80A	5x25	54	3x80A	4x25	5x25	58 A	3x100A*	3x25*	
	45	3x100A	5x25	68	3x100A	4x25	5x25	65 A	3x125A*	3x35*	
	60	3x100A	5x25	81	3x100A	4x25	5x25	87 A	3x125A*	3x35*	
	80	3x125A	5x50	108	3x125A	4x50	5x50	116 A	3x160A*	3x50*	
	90	3x160A	5x50	121	3x160A	4x50	5x50	130 A	3x200A*	3x70*	
	100	3x160A	5x50	135	3x160A	4x50	5x50	145 A	3x224A*	3x95*	
	120	3x200A	5x70	161	3x200A	4x70	5x70	174 A	3x250A*	3x120*	
	160	3x250A	5x120 or 5x(2x50)	215	3x250A	4x120 or 4x(2x50)	5x120 or 5x(2x50)	232 A	3x350A*	3x(2x70)*	
	200	3x315A	5x185 or 5x(2x70)	267	3x315A	4x185 or 4x(2x70)	5x185 or 5x(2x70)	290 A	3x450A*	3x(2x95)*	

\*1 only valid for common battery use