

PACSystems™ RX3i

IC694MDL754

GFK-2378F
January 2016

Output Module, 12/24VDC, 0.75A, 32-Point Grouped, with ESCP

The **12/24 volt DC, ESCP 0.75A Positive Logic Output** module, IC694MDL754, provides 32 discrete outputs in two isolated groups of 16. Each group has its own common. The outputs are positive logic or sourcing-type outputs; they switch the loads on the positive side of the power supply, and supply current to the load. The outputs can switch user loads over the range of +12 to +24 VDC (+25%, -15%) and can source a maximum current of 0.75 Amps per point.

Each point has electronic overcurrent/short circuit protection and generates an individual fault if either condition exists. In addition to output driver faults being sent back to the RX3i controller, the module provides a loss of field side power fault, ESCP point failure within a group, field terminal block ON/OFF status and a DIP switch configuration mismatch fault.

Each group can be used to drive different loads. For example, one group might drive 24 VDC loads, and the other could drive 12 VDC loads. Power for the loads must be provided by the user.

A DIP switch on back of the module is used to select the outputs default mode: Force Off or Hold Last State. The module must be removed from the backplane to set this switch.

This module can be used with either a Box-style (IC694TBB032) or Spring-style (IC694TBS032) front Terminal Block. The Terminal Block is ordered separately.

The blue bands on the label show that MDL754 is a low-voltage module.

This module can be installed in any I/O slot in an RX3i system. It must be used with an RX3i CPU. It cannot be used with a Series 90-30 PLC CPU.

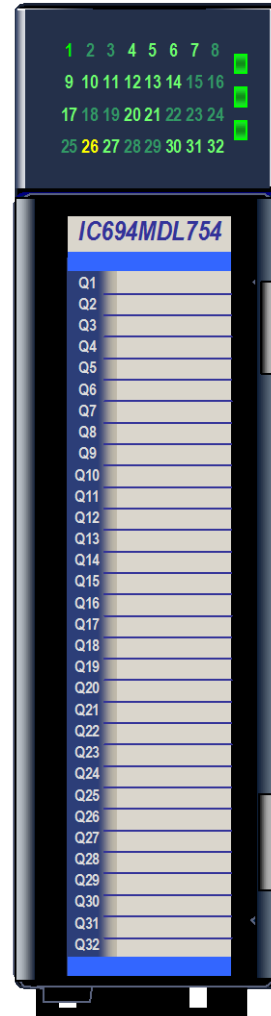

Electronic Short-circuit Protection

Each output point provides “self-recovering” protection against overcurrent, short circuit and overtemperature. The fault is present until the condition that caused the fault is removed or the faulted point is turned off. After the fault condition is removed the output driver automatically sets the output to the state it was in before the fault occurred.

Each output point provides transient voltage protection to clamp high voltages at or below 40VDC. Reverse voltage protection is provided for field power inputs.

* Indicates a trademark of General Electric Company and/or its subsidiaries. All other trademarks are the property of their respective owners.

GFK-2378F

Release Information

Release History

Release	FW Version	Date	Comments
IC694MDL754-DD	1.20	Jan 2016	Updated modules are RoHS converted product with applicable exemptions. No change in form-fit-functionality
IC694MDL754-CD	1.20	Mar 2009	Backward compatible with all previous versions.
IC694MDL754-CC	1.10	Feb 2008	Backward compatible with all previous versions.
IC694MDL754-BC	1.10	Nov 2005	Backward compatible with all previous versions.
IC694MDL754-AB	1.00	May 2005	Compatible with PACSystems RX3i CPU 3.0 firmware or later.
IC694MDL754A	1.00	Mar 2005	Initial Release. Compatible with PACSystems RX3i CPU 2.9 firmware only.



Upgrade Information

Previous versions can be upgraded to firmware version 1.20 using upgrade kit 44A753028-GO2, which can be downloaded from <http://support.ge-ip.com>.

Problems Resolved by This Release

None

Installation in Hazardous Locations

- EQUIPMENT LABELED WITH REFERENCE TO CLASS I, GROUPS A, B, C & D, DIV. 2 HAZARDOUS LOCATIONS IS SUITABLE FOR USE IN CLASS I, DIVISION 2, GROUPS A, B, C, D OR NON-HAZARDOUS LOCATIONS ONLY
-  WARNING – EXPLOSION HAZARD – SUBSTITUTION OF COMPONENTS MAY IMPAIR SUITABILITY FOR CLASS I, DIVISION 2;
-  WARNING – EXPLOSION HAZARD – WHEN IN HAZARDOUS LOCATIONS, TURN OFF POWER BEFORE REPLACING OR WIRING MODULES; AND
-  WARNING – EXPLOSION HAZARD – DO NOT CONNECT OR DISCONNECT EQUIPMENT UNLESS POWER HAS BEEN SWITCHED OFF OR THE AREA IS KNOWN TO BE NONHAZARDOUS.

Specifications: IC694MDL754

Rated Voltage	12/24 volts DC, nominal
Output Voltage Range	10.2 to 30 volts DC
Outputs per Module	32 (two isolated groups of 16 outputs each)
Isolation:	
Field to Backplane (optical) and to Frame Ground	250 VAC continuous; 1500 VAC for 1 minute
Group to Group	250 VAC continuous; 1500 VAC for 1 minute
Module ID	0x059h
Output Current	0.75 Amps per point
Power Consumption	300 mA (maximum) from 5 volt bus on backplane;
Thermal Derating	No derating at 24VDC. At 30VDC, outputs are derated above 42 degrees C as shown below.
External Power Supply	+12 VDC to +30 VDC, 12/24 VDC nominal
External Power Supply Current Required (not including load current)	Module version –CC and later: 72 mA/group with all outputs commanded Off, 132 mA/group with all outputs commanded ON Module version –BC and earlier: 72 mA/group with all outputs commanded OFF, 100 mA/group with all outputs commanded ON
Output Characteristics	
Inrush Current	3 Amps supplied for 10ms without ESCP trip
Output Voltage Drop	0.3 volt DC maximum
Steady-state overcurrent trip	5 Amps typical per point
Output Leakage Current	0.1mA maximum
On Response Time	0.5ms maximum
Off Response Time	0.5ms maximum
Protection	Short-circuit protection, overcurrent protection, overtemperature protection, all with auto recovery.

Refer to the PACSystems RX3i System Manual, GFK-2314, for product standards and general specifications.

Output Points vs. Temperature

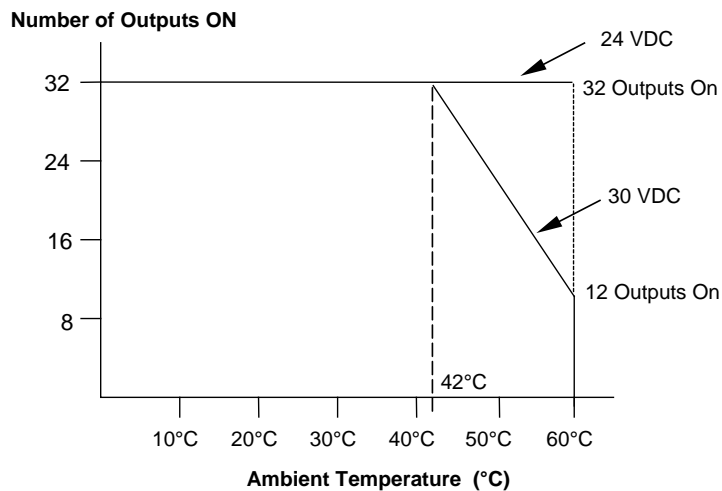

GFK-2378F

LEDs

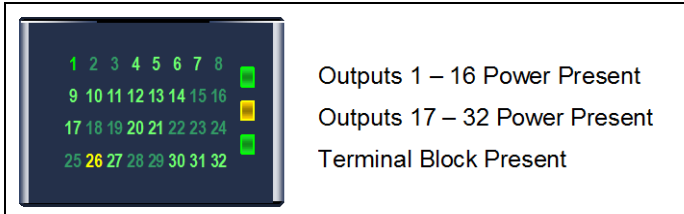

32 green/yellow LEDs on the module indicate the ON/OFF status of points 1 through 32. These LEDs are green when the corresponding outputs are on, and yellow if the outputs are faulted. They are off when the corresponding outputs are off.

Two green/yellow LEDs indicate the presence of field power to each of the isolated output groups. They are green if field power is within limits. They are yellow if a point fault exists within their group. And they are off when field power is absent or outside operating limits.

The module's red/green Terminal Block LED is green when the module's removable terminal block is locked in place. It is red when the terminal block is not locked. The Terminal Block LED blinks if there is a non-recoverable module fault. The module also sends an *Addition of Terminal Block* or *Loss of Terminal Block* message to the RX3i CPU to report the Terminal Block status.

Setting the Output Defaults

The DIP switch on back of the module selects the default operation for the module's outputs. The module must be removed from the backplane to set this switch. Note that there are two DIP switches on the module. Only the upper switch is used for this module.

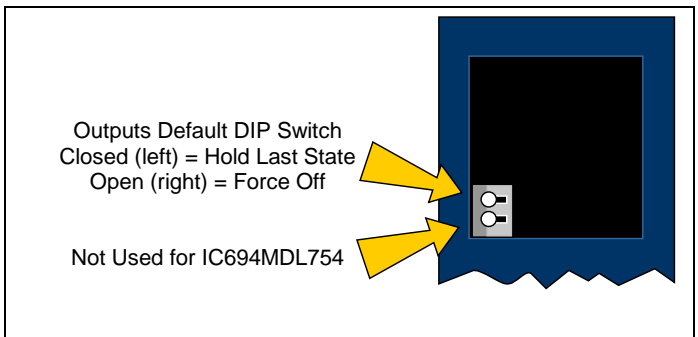

With the Outputs Default switch in the right (open) position, the outputs mode is set to Force Off. In this mode, the outputs will go to zero whenever communication with the CPU is lost. When the switch is in the left position, the Outputs Default mode is set to Hold Last State. In this mode the outputs will retain their last programmed value whenever communication with the CPU is lost, and field power is present.

The Outputs Default selection made with the DIP switch must match the selection made for this feature in the module's software configuration. If the two do not match, a fault occurs.

The table below summarizes the operation of Outputs Default mode with and without backplane power and field (external) power.

Backplane Power	Field Power	Outputs Default	Operation
On	On	Force Off or Hold Last State	Normal Operation. If module fault detected, outputs are set to zero.
On	Off	Force Off or Hold Last State	Module detects loss of field power, communicates fault to CPU while setting outputs to Off state. After field power is restored, the outputs are held in Off state until the module receives new output data from the CPU. Point LEDs indicate desired output without field power.
Off	On	Force Off	Module detects loss of communications and turns off the outputs within 400ms. LEDs are off.
		Hold Last State	Module detects loss of communications and holds outputs on their last states until the CPU sends new output data. LEDs are off

Field Wiring: MDL754

Field wiring connections to the module are made to the removable terminal assembly, as described in the *RX3i System Manual*, GFK-2314.

Connections	Terminals	Terminals	Connections
Output 1	1	19	Output 17
Output 2	2	20	Output 18
Output 3	3	21	Output 19
Output 4	4	22	Output 20
Output 5	5	23	Output 21
Output 6	6	24	Output 22
Output 7	7	25	Output 23
Output 8	8	26	Output 24
Output 9	9	27	Output 25
Output 10	10	28	Output 26
Output 11	11	29	Output 27
Output 12	12	30	Output 28
Output 13	13	31	Output 29
Output 14	14	32	Output 30
Output 15	15	33	Output 31
Output 16	16	34	Output 32
DC+ for 1 - 16	17	35	DC+ for 17 - 32
DC- for 1 - 16	18	36	DC- for 17 - 32

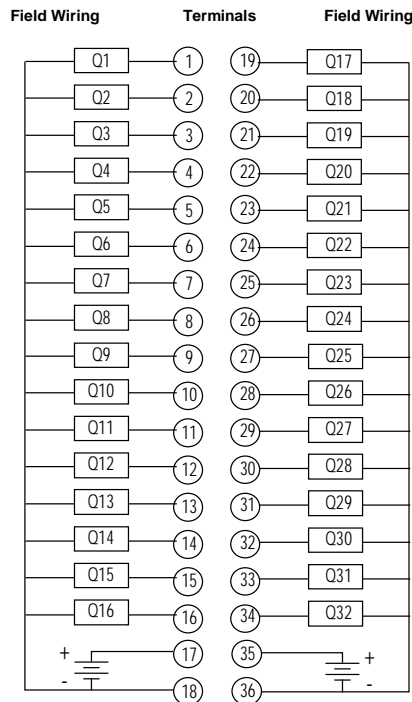

1-800-433-2682
 1-434-978-5100
www.ge-ip.com

