

Interface relays and optocouplers

Product group picture

5

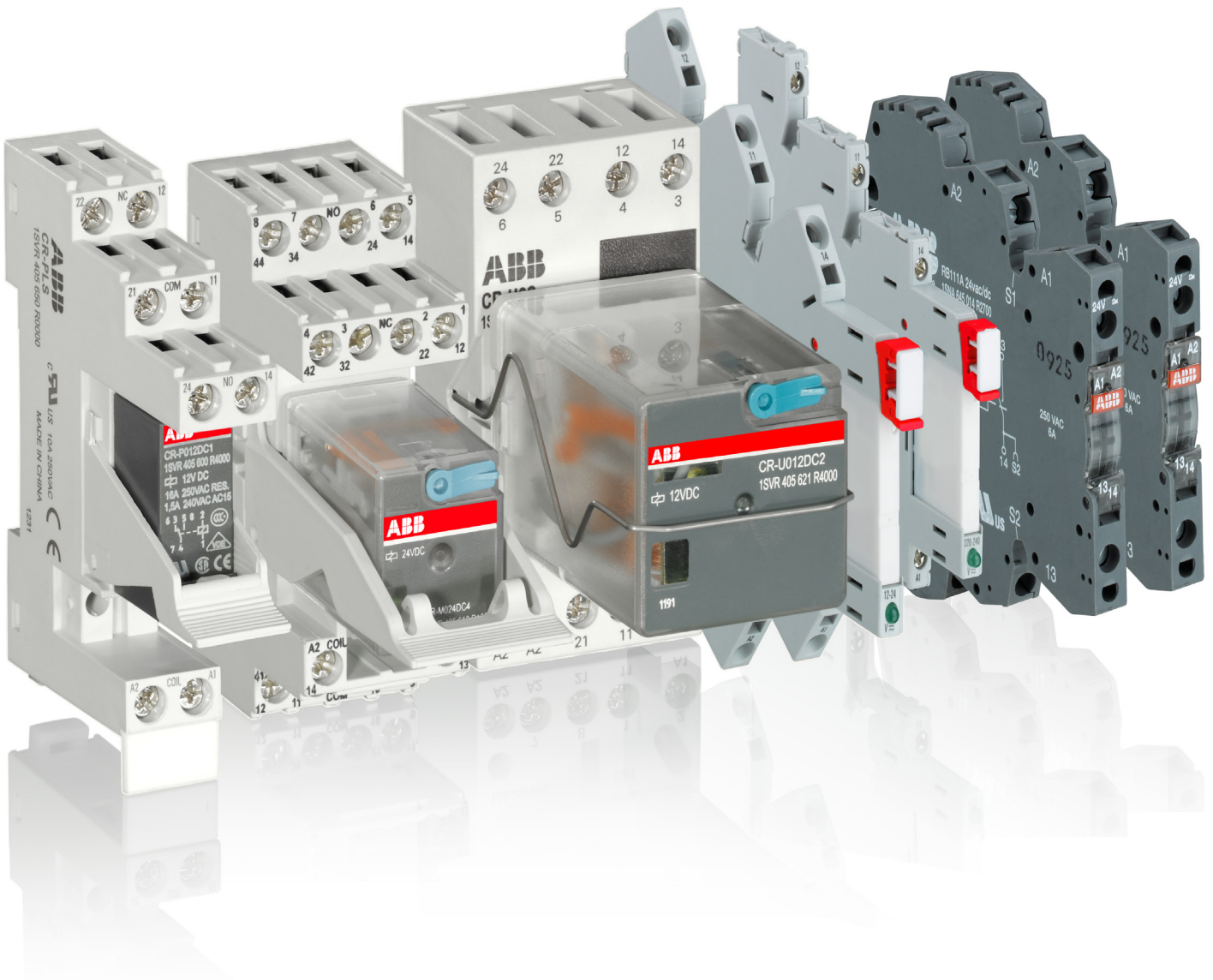

Interface relays and optocouplers

Table of contents

Interface Relays and Optocouplers

Pluggable interface relays	5/3
Table of contents	5/4
Benefits and advantages	5/5
Approvals and marks	5/7
Ordering details - CR-S range	5/8
Ordering details - CR-P range	5/9
Ordering details - CR-M range	5/10
Ordering details CR-P/M functional modules	5/13
Ordering details - CR-U range	5/14
Ordering details - CR-U accessories	5/15
Technical data - CR-P, CR-M, CR-U	5/16
Technical data, load limit curves - CR-P, CR-M, CR-U	5/18
Technical data - Sockets for CR-P and CR-M	5/19
Technical data - Sockets for CR-U	5/20
Technical data - CR-S range	5/21
Technical data - CR-S range sockets	5/22
Load limit curves	5/23
Connection diagrams	5/24
Dimensional drawings	5/25
Interface relays and optocouplers R600 range	5/27
Table of contents	5/28
Benefits and advantages	5/29
Type designators	5/30
Interface relays R600 range.....	5/31
Benefits and advantages	5/31
Selection	5/33
Ordering details	5/35
Connection diagrams	5/37
Technical data	5/38
General technical data	5/43
Dimensional drawings, Load limit curves	5/44
Optocouplers R600 range.....	5/45
Selection	5/45
Ordering details	5/47
Connection diagrams	5/48
Technical data	5/49

Pluggable interface relays

Product group picture

5

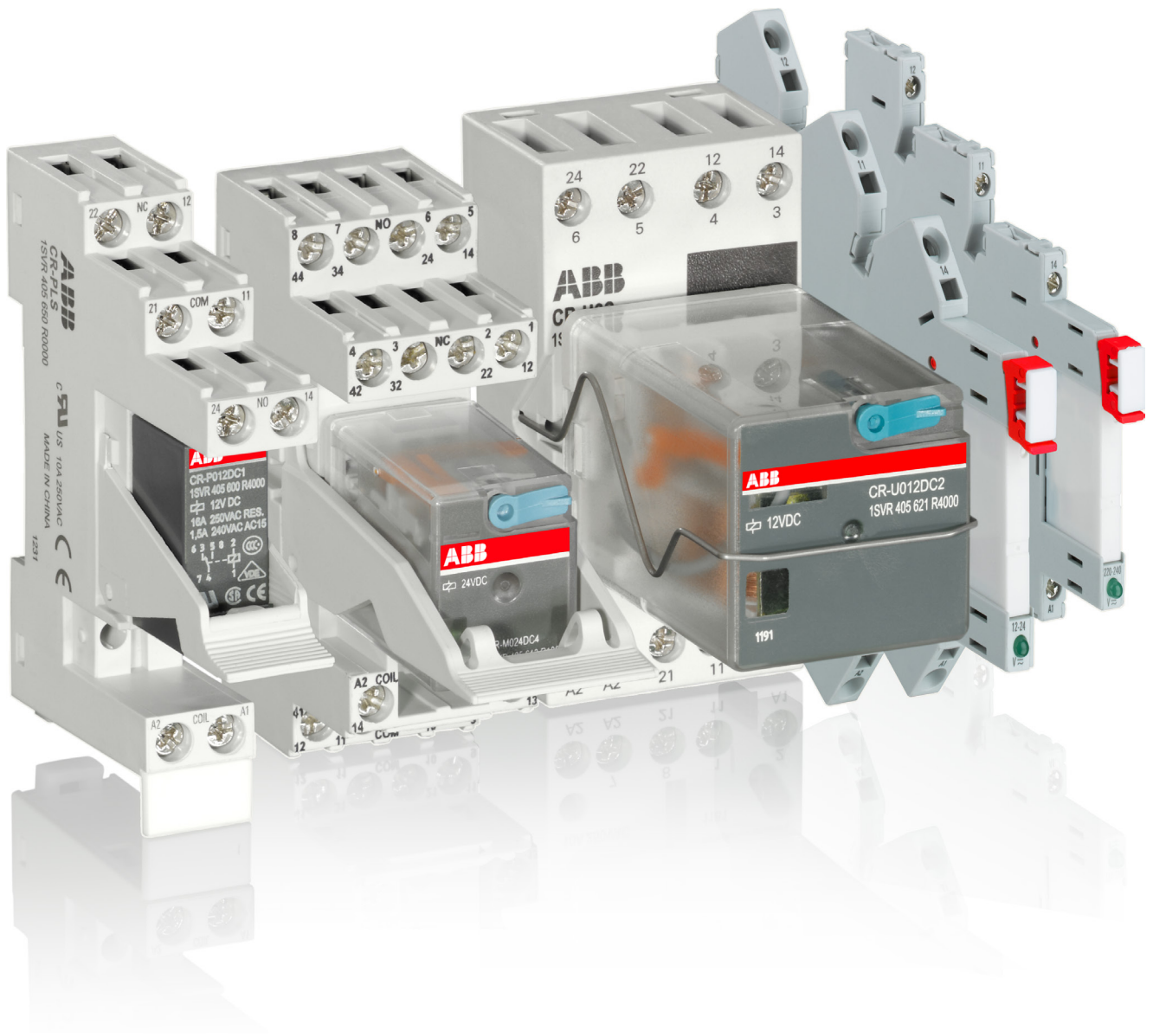

Pluggable interface relays

Table of contents

Pluggable interface relays

Benefits and advantages	5/5
Approvals and marks	5/7
Ordering details - CR-S range	5/8
Ordering details - CR-P range	5/9
Ordering details - CR-M range	5/10
Ordering details CR-P/M functional modules	5/13
Ordering details - CR-U range	5/14
Ordering details - CR-U accessories	5/15
Technical data - CR-P, CR-M, CR-U	5/16
Technical data, load limit curves - CR-P, CR-M, CR-U	5/18
Technical data - Sockets for CR-P and CR-M	5/19
Technical data - Sockets for CR-U	5/20
Technical data - CR-S range	5/21
Technical data - CR-S range sockets	5/22
Load limit curves	5/23
Connection diagrams	5/24
Dimensional drawings	5/25

Pluggable interface relays

Benefits and advantages

Slim relays CR-S

- Standard slim relays (5 mm), sockets (6.2 mm) and accessories
- Combination of 9 different rated control supply voltages possible:
 - DC versions: 5 V, 12 V, 24 V
 - AC/DC versions: 12 V, 24 V, 48 V, 60 V, 110 V, 230 V
- Output: 1 c/o (SPDT) contacts (6 A), standard and goldplated contacts
- Cadmium-free contact material
- All sockets with LED
- Screw and spring connection terminals
- Jumper bar (red, black, blue), marker and separator available as accessories

Pluggable pcb relays CR-P

- 9 different coil voltages
 - DC versions: 12 V, 24 V, 48 V, 110 V
 - AC versions: 24 V, 48 V, 110 V, 120 V, 230 V
- Output contacts:
 - 1 c/o contact (16 A) or
 - 2 c/o contacts (8 A) optionally equipped with gold contacts
- Logical or standard sockets
- Cadmium-free contact material
- Width of socket: 15,5 mm
- Pluggable function modules
 - Reverse polarity protection/Free wheeling diode
 - LED indication
 - RC elements
 - Overvoltage protection

5

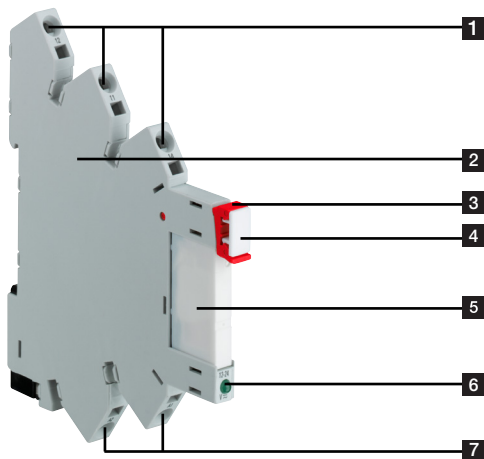

- 1** Output contacts
- 2** Socket
- 3** Relay holder
- 4** Marker
- 5** Interface relay
- 6** LED green: Control supply voltage applied
- 7** Control supply voltage

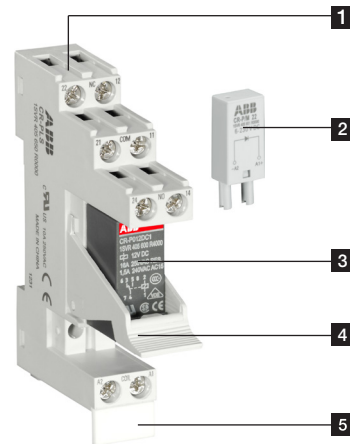

- 1** Socket
- 2** Pluggable function module
- 3** Interface relay
- 4** Holder
- 5** Marker label

Pluggable interface relays

Benefits and advantages

Pluggable miniature relays CR-M

- 2 different coil voltages
 - DC versions: 12 V, 24 V, 48 V, 60 V, 110 V, 125 V, 220 V
 - AC versions: 24 V, 48 V, 110 V, 120 V, 230 V
- Output contacts
 - 2 c/o contacts (12 A)
 - 3 c/o contacts (10 A) or
 - 4 c/o contacts (6 A)
 optionally equipped with gold contacts, LED and free wheeling diode
- Integrated test button for manual actuation and locking of the output contacts (blue = DC, orange = AC) that can be removed if necessary
- With or without integrated LED
- Logical or standard sockets
- Cadmium-free contact material
- Width on socket: 27 mm
- Pluggable function modules
 - Reverse polarity protection/Free wheeling diode
 - LED indication
 - RC elements
 - Overvoltage protection

Pluggable universal relays CR-U

- 12 different coil voltages
 - DC versions: 12 V, 24 V, 48 V, 110 V, 125 V, 220 V
 - AC versions: 24 V, 48 V, 60 V, 110 V, 120 V, 230 V
- Output contacts
 - 2 c/o contacts (10 A) or
 - 3 c/o contacts (10 A)
- Integrated test button for manual actuation and locking of the output contacts (blue = DC, orange = AC) that can be removed if necessary
- With or without integrated LED
- Cadmium-free contact material
- Width on socket: 38 mm
- Pluggable function modules
 - Reverse polarity protection/Free wheeling diode
 - LED indication
 - RC elements
 - Overvoltage protection
 - Multifunction time module

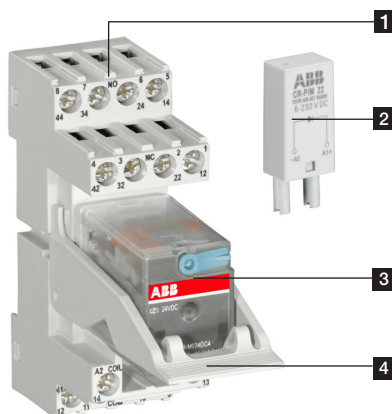

- 1 Socket
- 2 Pluggable function module
- 3 Interface relay
- 4 Holder



- 1 Socket
- 2 Pluggable function module
- 3 Interface relay
- 4 Holder

Pluggable interface relays

Approvals and marks

Kind of connecting terminals

Kinds of sockets

Standard sockets - Position of connecting terminals:
Coil connection (A1-A2) on lower socket side, contact connections (n/o and n/c contacts) on the lower and upper socket side.

Logical sockets - Position of connecting terminals:
Coil connection (A1-A2) on lower socket side, all contact connections (common contacts, n/o and n/c contacts) on upper socket side.

Details see connection diagrams

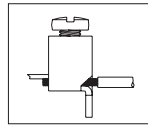

Screw type

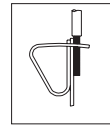

Spring type

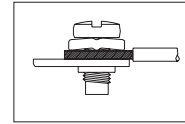

Fork type

Approvals and marks

- existing
- pending

		Relays				Sockets								Modules	
		CR-S	CR-P	CR-M	CR-U	CR-S sockets	CR-PLS CR-PSS	CR-PLC	CR-M..L. CR-M..SS	CR-M..SF	CR-U..S CR-U..E	CR-U..SM	CR-P/M	CR-U	
Approvals															
	ANSI/UL 508	■	■	■	■	■	■	■	■	■			■	■ ⁶⁾	
	CAN/CSA C22.2 No.14	■	■	■		■	■ ¹⁾	■	■ ²⁾	■	■ ³⁾	■	■	■ ⁶⁾	
	CAN/CSA C22.2 No.14	■	■	■	■	■									
	VDE	■ ⁸⁾		■ ⁴⁾	■	■ ⁸⁾									
	EAC	■	■	■	■	■	■	■	■	■	■		■	■	
	Lloyds Register			■ ⁵⁾	■										
	CCC		■	■	■										
	CQC	■													
	RMRS		■	■ ⁷⁾	■ ⁷⁾	■	■	■	■	■	■				
Marks															
	CE	■	■	■	■	■	■	■	■	■	■		■	■	

¹⁾ except CR-PLSx
²⁾ except CR-M...LC
³⁾ except CR-U3E
⁴⁾ except 125 V DC devices
⁵⁾ only devices with 4 c/o contacts
⁶⁾ except CR-U61D, CR-U61DV
⁷⁾ except 60 V and 125 V devices
⁸⁾ only relays and sockets with screw terminals

Pluggable interface relays

Ordering details - CR-S range



CR-S

2CDC 291 005 F0014

Description

The pluggable interface relays of the CR-S Range are used for electrical isolation, amplification and signal matching between the electronic controlling, e.g. PLC, iPC or field bus systems and the sensor / actuator level. The CR-S Range combines the flexibility of a modular system and the ability of switching high currents on a small footprint thus can be used in applications where space saving is essential.

Ordering details - CR-S range pluggable interface relays

Rated control supply voltage	Outputs	Contact ratings	Type	Order code	Price	Pkg qty	Weight (1 pce) kg (lb)
5 V DC	1 c/o (SPDT) standard contacts	250 V, 6 A	CR-S005VDC1R	1SVR405501R1010		10	0.005 (0.011)
12 V DC			CR-S012VDC1R	1SVR405501R2010			
24 V DC			CR-S024VDC1R	1SVR405501R3010			
48 V DC			CR-S048VDC1R	1SVR405501R4010			
60 V DC			CR-S060VDC1R	1SVR405501R5010			
5 V DC	1 c/o (SPDT) gold plated contacts	12 V, 250 mA (3W) ¹⁾	CR-S005VDC1RG	1SVR405501R1020		10	0.005 (0.011)
12 V DC			CR-S012VDC1RG	1SVR405501R2020			
24 V DC			CR-S024VDC1RG	1SVR405501R3020			
48 V DC			CR-S048VDC1RG	1SVR405501R4020			
60 V DC			CR-S060VDC1RG	1SVR405501R5020			

Ordering details - CR-S range complete interface relays (relay + socket)

Rated control supply voltage	Outputs	Contact ratings	Type	Order code	Price	Pkg qty	Weight (1 pce) kg (lb)
24 V AC/DC	1 c/o (SPDT) standard contacts	250 V, 6 A	CR-S024VADC1CRS	1SVR405541R3110		10	0.03 (0.066)
110 V AC/DC			CR-S024VADC1CRZ	1SVR405541R3210			
			CR-S110VADC1CRS	1SVR405541R6110			
			CR-S110VADC1CRZ	1SVR405541R6210			
230 V AC/DC			CR-S230VADC1CRS	1SVR405541R7110			
	CR-S230VADC1CRZ	1SVR405541R7210					
24 V AC/DC	1 c/o (SPDT) gold plated contacts	12 V, 250 mA (3W) ¹⁾	CR-S024VADC1CRGS	1SVR405541R3120		10	0.03 (0.066)
110 V AC/DC			CR-S024VADC1CRGZ	1SVR405541R3220			
			CR-S110VADC1CRGS	1SVR405541R6120			
			CR-S110VADC1CRGZ	1SVR405541R6220			
230 V AC/DC			CR-S230VADC1CRGS	1SVR405541R7120			
	CR-S230VADC1CRGZ	1SVR405541R7220					

¹⁾ If specified maximum values exceeded, the gold plating is destroyed. The maximum values of the standard contacts are then valid.

RS, SS = screw connection type
RZ, SZ = spring connection type

Ordering details - CR-S range sockets

Rated control supply voltage	Connection type	Type	Order code	Price	Pkg qty	Weight (1 pce) kg (lb)
6-24 V DC	Screw	CR-S006/024VDC1SS	1SVR405521R1100		10	0.025 (0.055)
	Spring	CR-S006/024VDC1SZ	1SVR405521R1200			
12-24 V AC/DC	Screw	CR-S012/024VADC1SS	1SVR405521R3100		10	0.025 (0.055)
	Spring	CR-S012/024VADC1SZ	1SVR405521R3200			
48-60 V AC/DC	Screw	CR-S048/060VADC1SS	1SVR405521R5100		10	0.025 (0.055)
	Spring	CR-S048/060VADC1SZ	1SVR405521R5200			
110-125 V AC/DC	Screw	CR-S110/125VADC1SS	1SVR405521R6100		10	0.025 (0.055)
	Spring	CR-S110/125VADC1SZ	1SVR405521R6200			
220-240 V AC/DC	Screw	CR-S220/240VADC1SS	1SVR405521R7100		10	0.025 (0.055)
	Spring	CR-S220/240VADC1SZ	1SVR405521R7200			

Ordering details - CR-S range accessories

Version	Type	Order code	Price	Pkg qty	Weight (1 pce) kg (lb)
Jumper bar 20 pole, blue color	CR-SJB20-BLUE	1SVR405598R0700		10	0.008 (0.018)
Jumper bar 20 pole, red color	CR-SJB20-RED	1SVR405598R0800			
Jumper bar 20 pole, black color	CR-SJB20-BLACK	1SVR405598R0900			
Marker block	CR-SM	1SNB041391R0610		10	0.0036 (0.0079)
Separator	CR-SSEP	1SVR405599R0000		10	0.012 (0.026)

Pluggable interface relays

Ordering details - CR-P range



CR-P

2CDC 281 045 F0004

Ordering details - CR-P range

Rated control supply voltage	Outputs	Contact ratings	Type	Order code	Price	Pkg	Weight (1 pce)
						qty	kg (lb)
12 V DC	1 c/o (SPDT)	250 V, 16 A	CR-P012DC1	1SVR405600R4000		10	0.014 (0.031)
24 V DC			CR-P024DC1	1SVR405600R1000			
48 V DC			CR-P048DC1	1SVR405600R6000			
110 V DC			CR-P110DC1	1SVR405600R8000			
24 V AC			CR-P024AC1	1SVR405600R0000			
48 V AC			CR-P048AC1	1SVR405600R5000			
110 V AC			CR-P110AC1	1SVR405600R7000			
120 V AC			CR-P120AC1	1SVR405600R2000			
230 V AC			CR-P230AC1	1SVR405600R3000			
12 V DC	2 c/o (SPDT)	250 V, 8 A	CR-P012DC2	1SVR405601R4000		10	0.014 (0.031)
24 V DC			CR-P024DC2	1SVR405601R1000			
48 V DC			CR-P048DC2	1SVR405601R6000			
110 V DC			CR-P110DC2	1SVR405601R8000			
24 V AC			CR-P024AC2	1SVR405601R0000			
48 V AC			CR-P048AC2	1SVR405601R5000			
110 V AC			CR-P110AC2	1SVR405601R7000			
120 V AC			CR-P120AC2	1SVR405601R2000			
230 V AC			CR-P230AC2	1SVR405601R3000			
24 V DC	2 c/o (SPDT) gold contact	250 V, 8 A	CR-P024DC2G	1SVR405606R1000		10	0.014 (0.031)
24 V AC			CR-P024AC2G	1SVR405606R0000			
110 V AC			CR-P110AC2G	1SVR405606R7000			
230 V AC			CR-P230AC2G	1SVR405606R3000			

5



CR-PLS

2CDC 281 008 F0011

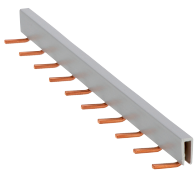

CR-PJ

2CDC 281 004 F0007

Ordering details - Accessories

Version	Connection terminal	Type	Order code	Price	Pkg	Weight (1 pce)
					qty	kg (lb)
Logical socket with protective separation	screw	CR-PLS	1SVR405650R0000		10	0.045 (0.099)
	screw	CR-PLSx	1SVR405650R0100			0.043 (0.095)
Logical socket	spring	CR-PLC	1SVR405650R0200		10	0.042 (0.093)
	screw	CR-PSS	1SVR405650R1000			0.038 (0.084)
Standard socket	screw	CR-PSS	1SVR405650R1000		10	0.002 (0.004)
Plastic holder for socket		CR-PH	1SVR405659R0000			0.018 (0.040)
Jumper bar for sockets with screw connection		CR-PJ	1SVR405658R5000		10	0.0002 (0.0004)
Marker		CR-PM	1SVR405658R0000			

Pluggable interface relays

Ordering details - CR-M range



CR-M

2CDC 281 046 F0004

Ordering details - CR-M range without LED

Rated control supply voltage	Outputs	Contact ratings	Type	Order code	Price	Pkg qty	Weight (1 pce) kg (lb)				
12 V DC	2 c/o (SPDT)	250 V, 12 A	CR-M012DC2	1SVR405611R4000		10	0.033 (0.073)				
24 V DC			CR-M024DC2	1SVR405611R1000							
48 V DC			CR-M048DC2	1SVR405611R6000							
60 V DC			CR-M060DC2	1SVR405611R4200							
110 V DC			CR-M110DC2	1SVR405611R8000							
125 V DC			CR-M125DC2	1SVR405611R8200							
220 V DC			CR-M220DC2	1SVR405611R9000							
24 V AC			CR-M024AC2	1SVR405611R0000							
48 V AC			CR-M048AC2	1SVR405611R5000							
110 V AC			CR-M110AC2	1SVR405611R7000							
120 V AC			CR-M120AC2	1SVR405611R2000							
230 V AC			CR-M230AC2	1SVR405611R3000							
12 V DC			3 c/o (SPDT)	250 V, 10 A	CR-M012DC3			1SVR405612R4000		10	0.033 (0.073)
24 V DC					CR-M024DC3			1SVR405612R1000			
48 V DC	CR-M048DC3	1SVR405612R6000									
60 V DC	CR-M060DC3	1SVR405612R4200									
110 V DC	CR-M110DC3	1SVR405612R8000									
125 V DC	CR-M125DC3	1SVR405612R8200									
220 V DC	CR-M220DC3	1SVR405612R9000									
24 V AC	CR-M024AC3	1SVR405612R0000									
48 V AC	CR-M048AC3	1SVR405612R5000									
60 V AC	CR-M060AC3	1SVR405612R5200									
110 V AC	CR-M110AC3	1SVR405612R7000									
120 V AC	CR-M120AC3	1SVR405612R2000									
230 V AC	CR-M230AC3	1SVR405612R3000									
12 V DC	4 c/o (SPDT)	250 V, 6 A			CR-M012DC4	1SVR405613R4000		10	0.033 (0.073)		
24 V DC			CR-M024DC4	1SVR405613R1000							
48 V DC			CR-M048DC4	1SVR405613R6000							
60 V DC			CR-M060DC4	1SVR405613R4200							
110 V DC			CR-M110DC4	1SVR405613R8000							
125 V DC			CR-M125DC4	1SVR405613R8200							
220 V DC			CR-M220DC4	1SVR405613R9000							
24 V AC			CR-M024AC4	1SVR405613R0000							
48 V AC			CR-M048AC4	1SVR405613R5000							
110 V AC			CR-M110AC4	1SVR405613R7000							
120 V AC			CR-M120AC4	1SVR405613R2000							
230 V AC			CR-M230AC4	1SVR405613R3000							

Pluggable interface relays

Ordering details - CR-M range



CR-M

2CDC 281 048 F0004

5

Ordering details - CR-M range with LED

Rated control supply voltage	Outputs	Contact ratings	Type	Order code	Price	Pkg	Weight				
						qty	(1 pce) kg (lb)				
12 V DC	2 c/o (SPDT)	250 V, 12 A	CR-M012DC2L	1SVR405611R4100		10	0.033 (0.073)				
24 V DC			CR-M024DC2L	1SVR405611R1100							
48 V DC			CR-M048DC2L	1SVR405611R6100							
60 V DC			CR-M060DC2L	1SVR405611R4300							
110 V DC			CR-M110DC2L	1SVR405611R8100							
125 V DC			CR-M125DC2L	1SVR405611R8300							
220 V DC			CR-M220DC2L	1SVR405611R9100							
24 V AC			CR-M024AC2L	1SVR405611R0100							
48 V AC			CR-M048AC2L	1SVR405611R5100							
110 V AC			CR-M110AC2L	1SVR405611R7100							
120 V AC			CR-M120AC2L	1SVR405611R2100							
230 V AC			CR-M230AC2L	1SVR405611R3100							
12 V DC			3 c/o (SPDT)	250 V, 10 A	CR-M012DC3L			1SVR405612R4100		10	0.033 (0.073)
24 V DC					CR-M024DC3L			1SVR405612R1100			
48 V DC	CR-M048DC3L	1SVR405612R6100									
60 V DC	CR-M060DC3L	1SVR405612R4300									
110 V DC	CR-M110DC3L	1SVR405612R8100									
125 V DC	CR-M125DC3L	1SVR405612R8300									
220 V DC	CR-M220DC3L	1SVR405612R9100									
24 V AC	CR-M024AC3L	1SVR405612R0100									
48 V AC	CR-M048AC3L	1SVR405612R5100									
110 V AC	CR-M110AC3L	1SVR405612R7100									
120 V AC	CR-M120AC3L	1SVR405612R2100									
230 V AC	CR-M230AC3L	1SVR405612R3100									
12 V DC	4 c/o (SPDT)	250 V, 6 A			CR-M012DC4L	1SVR405613R4100		10	0.033 (0.073)		
24 V DC					CR-M024DC4L	1SVR405613R1100					
48 V DC			CR-M048DC4L	1SVR405613R6100							
60 V DC			CR-M060DC4L	1SVR405613R4300							
110 V DC			CR-M110DC4L	1SVR405613R8100							
125 V DC			CR-M125DC4L	1SVR405613R8300							
220 V DC			CR-M220DC4L	1SVR405613R9100							
24 V AC			CR-M024AC4L	1SVR405613R0100							
48 V AC			CR-M048AC4L	1SVR405613R5100							
110 V AC			CR-M110AC4L	1SVR405613R7100							
120 V AC			CR-M120AC4L	1SVR405613R2100							
230 V AC			CR-M230AC4L	1SVR405613R3100							

Ordering details - CR-M range with LED and free-wheeling diode

Rated control supply voltage	Outputs	Contact ratings	Type	Order code	Price	Pkg	Weight
						qty	(1 pce) kg (lb)
24 V DC	4 c/o (SPDT)	250 V, 6 A	CR-M024DC4LD	1SVR405614R1100		10	0.033 (0.073)

Ordering details - CR-M range with gold contacts

Rated control supply voltage	Outputs	Contact ratings	Type	Order code	Price	Pkg	Weight
						qty	(1 pce) kg (lb)
24 V DC	4 c/o (SPDT), gold contacts	250 V, 6 A	CR-M024DC4G	1SVR405618R1000		10	0.033 (0.073)
24 V AC			CR-M024AC4G	1SVR405618R0000			
110 V AC			CR-M110AC4G	1SVR405618R7000			
230 V AC			CR-M230AC4G	1SVR405618R3000			

Pluggable interface relays

Ordering details - CR-M range



CR-M

2CDC 291 046 F0004

Ordering details – CR-M range with gold contacts and LED

Rated control supply voltage	Outputs	Contact ratings	Type	Order code	Price	Pkg	Weight (1 pce)		
						qty	kg (lb)		
12 V DC	4 c/o (SPDT) with gold contacts and LED	250 V / 6 A	CR-M012DC4LG	1SVR405618R4100		10	0.033 (0.073)		
24 V DC			CR-M024DC4LG	1SVR405618R1100					
48 V DC			CR-M048DC4LG	1SVR405618R6100					
60 V DC			CR-M060DC4LG	1SVR405618R4300					
110 V DC			CR-M110DC4LG	1SVR405618R8100					
125 V DC			CR-M125DC4LG	1SVR405618R8300					
220 V DC			CR-M220DC4LG	1SVR405618R9100					
24 V AC			CR-M024AC4LG	1SVR405618R0100				10	0.033 (0.073)
48 V AC			CR-M048AC4LG	1SVR405618R5100					
110 V AC			CR-M110AC4LG	1SVR405618R7100					
120 V AC	CR-M120AC4LG	1SVR405618R2100							
230 V AC	CR-M230AC4LG	1SVR405618R3100							

Ordering details – CR-M range with gold contacts, LED and free-wheeling diode

Rated control supply voltage	Outputs	Contact ratings	Type	Order code	Price	Pkg	Weight (1 pce)
						qty	kg (lb)
12 V DC	4 c/o (SPDT) with gold contacts, LED and free-wheeling diode		CR-M012DC4LDG	1SVR405618R4400		10	0.033 (0.073)
24 V DC			CR-M024DC4LDG	1SVR405618R1400			

Ordering details - Accessories

Version	Connection terminal	Type	Order code	Price	Pkg	Weight (1 pce)
					qty	kg (lb)
Logical socket for 2 c/o	screw	CR-M2LS	1SVR405651R1100		10	0.055 (0.121)
Logical socket for 3 c/o		CR-M3LS	1SVR405651R2100			0.062 (0.137)
Logical socket for 2/4 c/o		CR-M4LS	1SVR405651R3100			0.066 (0.146)
Logical socket for 2 c/o	spring	CR-M2LC	1SVR405651R1200		10	0.065 (0.143)
Logical socket for 2/4 c/o		CR-M4LC	1SVR405651R3200			0.066 (0.146)
Standard socket for 2 c/o	screw	CR-M2SS	1SVR405651R1000		10	0.066 (0.146)
Standard socket for 3 c/o		CR-M3SS	1SVR405651R2000			0.068 (0.150)
Standard socket for 2/4 c/o		CR-M4SS	1SVR405651R3000			0.070 (0.154)
Standard socket for 2 c/o	fork type	CR-M2SF	1SVR405651R1300		10	0.040 (0.088)
Standard socket for 2/4 c/o		CR-M4SF	1SVR405651R3300			0.048 (0.106)
Plastic holder		CR-MH	1SVR405659R1000		10	0.003 (0.007)
Metal holder		CR-MH1	1SVR405659R1100		10	0.0005 (0.001)
Jumper bar for sockets with screw connection		CR-MJ	1SVR405658R6000		10	0.029 (0.064)
Marker		CR-MM	1SVR405658R1000		10	0.0005 (0.001)



CR-M4SS

2CDC 291 009 F0011



CR-MJ

2CDC 291 005 F0007

Pluggable interface relays

Ordering details CR-P/M functional modules



2CDC 291 005 S0011

CR-P/M ...

Ordering details - CR-P/M range (all products stocked)

Rated control supply voltage	Description	Version	Type	Order code	Price	Pkg	Weight (1 pce)	
							qty	kg (lb)
6-220 V DC	Diode - Reverse polarity protection/free wheeling diode	A1+, A2-	CR-P/M 22	1SVR405651R0000		10	0.003 (0.007)	
6-24 V DC	Diode and LED - Reverse polarity protection/free wheeling diode	red, A1+, A2-	CR-P/M 42	1SVR405652R0000		10	0.003 (0.007)	
24-60 V DC		green, A1+, A2-	CR-P/M 42V	1SVR405652R1000				
		red, A1+, A2-	CR-P/M 42B	1SVR405652R4000				
		green, A1+, A2-	CR-P/M 42BV	1SVR405652R4100				
110-230 V DC		red, A1+, A2-	CR-P/M 42C	1SVR405652R9000				
		green, A1+, A2-	CR-P/M 42CV	1SVR405652R9100				
6-24 V AC/DC	Spark quenching		CR-P/M 52B	1SVR405653R0000		10	0.003 (0.007)	
24-60 V AC/DC			CR-P/M 52D	1SVR405653R4000				
110-230 V AC/DC			CR-P/M 52C	1SVR405653R1000				
6-24 V AC/DC	Diode, LED and reverse polarity protection	red, for DC A1+, A2-	CR-P/M 62	1SVR405654R0000		10	0.003 (0.007)	
		green, for DC A1+, A2-	CR-P/M 62V	1SVR405654R1000				
24-60 V AC/DC		red, for DC A1+, A2-	CR-P/M 62E	1SVR405654R4000				
		green, for DC A1+, A2-	CR-P/M 62EV	1SVR405654R4100				
110 V DC		red, for DC A1+, A2-	CR-P/M 92	1SVR405654R0100				
110-230 V AC		green, for DC A1+, A2-	CR-P/M 92V	1SVR405654R1100				
6-24 V AC/DC	Varistor and LED Overvoltage protection	red, for DC A1+, A2-	CR-P/M 62C	1SVR405655R0000		10	0.003 (0.007)	
		green, for DC A1+, A2-	CR-P/M 62CV	1SVR405655R1000				
24-60 V AC/DC		red, for DC A1+, A2-	CR-P/M 62D	1SVR405655R4000				
		green, for DC A1+, A2-	CR-P/M 62DV	1SVR405655R4100				
110 V DC	Overvoltage protection	red, for DC A1+, A2-	CR-P/M 92C	1SVR405655R0100		10	0.002 (0.004)	
110-230 V AC		green, for DC A1+, A2-	CR-P/M 92CV	1SVR405655R1100				
24 V AC			CR-P/M 72	1SVR405656R0000				
115 V AC			CR-P/M 72A	1SVR405656R1000				
230 V AC			CR-P/M 82	1SVR405656R2000				

Connection diagrams

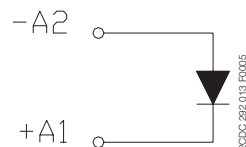

CR-P/M 22

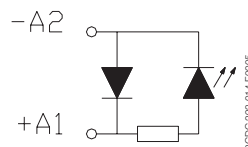

CR-P/M 42, CR-P/M 42B, CR-P/M 42C, CR-P/M 42V, CR-P/M 42BV, CR-P/M 42CV

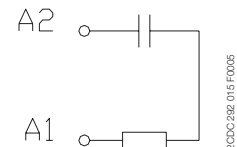

CR-P/M 52B, CR-P/M 52C

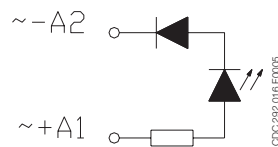

CR-P/M 62, CR-P/M 62E, CR-P/M 62EV, CR-P/M 62V, CR-P/M 62BV, CR-P/M 62CV

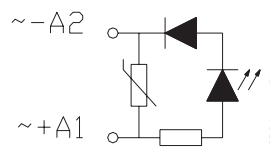

CR-P/M 62C, CR-P/M 62D, CR-P/M 62DV, CR-P/M 62CV, CR-P/M 92C, CR-P/M 92CV

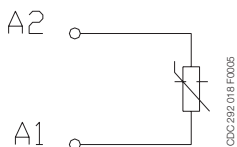

CR-P/M 72, CR-P/M 72A, CR-P/M 82

Pluggable interface relays

Ordering details - CR-U range



2CDC 291 047 F0004

CR-U

Description

Interface relays are widely used in various industrial applications:

As an interface they link the electronic controlling, e.g. PLC (programmable logic controller), PC or field bus systems, to the sensor / actuator level. Here, they take on various functions: Switching of AC or DC loads with different resistive, inductive and capacitive parts, switching voltages from a few mV up to 250 V, switching currents from a few mA up to 16 A, amplification of weak control signals, electrical isolation of control and load circuits, and signal multiplying. In contrast to electronic switching devices, interface relays don't use additional internal protective circuits and thus are overload-proof against short-time variations like current or voltage peaks.

Ordering details - CR-U range

Rated control supply voltage	Outputs	Contact ratings	Type	Order code	Price	Pkg qty	Weight (1 pce) kg (lb)				
12 V DC	2 c/o without LED	250 V, 10 A	CR-U012DC2	1SVR405621R4000		10	0.083 (0.183)				
24 V DC			CR-U024DC2	1SVR405621R1000							
48 V DC			CR-U048DC2	1SVR405621R6000							
110 V DC			CR-U110DC2	1SVR405621R8000							
220 V DC			CR-U220DC2	1SVR405621R9000							
24 V AC			CR-U024AC2	1SVR405621R0000							
48 V AC			CR-U048AC2	1SVR405621R5000							
110 V AC			CR-U110AC2	1SVR405621R7000							
120 V AC			CR-U120AC2	1SVR405621R2000							
230 V AC			CR-U230AC2	1SVR405621R3000							
12 V DC			3 c/o without LED	250 V, 10 A	CR-U012DC3			1SVR405622R4000		10	0.083 (0.183)
24 V DC					CR-U024DC3			1SVR405622R1000			
48 V DC					CR-U048DC3			1SVR405622R6000			
110 V DC					CR-U110DC3			1SVR405622R8000			
125 V DC	CR-U125DC3	1SVR405622R8200									
220 V DC	CR-U220DC3	1SVR405622R9000									
24 V AC	CR-U024AC3	1SVR405622R0000									
48 V AC	CR-U048AC3	1SVR405622R5000									
60 V AC	CR-U060AC3	1SVR405622R5200									
110 V AC	CR-U110AC3	1SVR405622R7000									
120 V AC	CR-U120AC3	1SVR405622R2000									
230 V AC	CR-U230AC3	1SVR405622R3000									
12 V DC	2 c/o with LED	250 V, 10 A			CR-U012DC2L	1SVR405621R4100		10	0.083 (0.183)		
24 V DC					CR-U024DC2L	1SVR405621R1100					
48 V DC			CR-U048DC2L	1SVR405621R6100							
110 V DC			CR-U110DC2L	1SVR405621R8100							
220 V DC			CR-U220DC2L	1SVR405621R9100							
24 V AC			CR-U024AC2L	1SVR405621R0100							
48 V AC			CR-U048AC2L	1SVR405621R5100							
110 V AC			CR-U110AC2L	1SVR405621R7100							
120 V AC			CR-U120AC2L	1SVR405621R2100							
230 V AC			CR-U230AC2L	1SVR405621R3100							
12 V DC			3 c/o with LED	250 V, 10 A	CR-U012DC3L	1SVR405622R4100				10	0.083 (0.183)
24 V DC					CR-U024DC3L	1SVR405622R1100					
48 V DC					CR-U048DC3L	1SVR405622R6100					
110 V DC					CR-U110DC3L	1SVR405622R8100					
220 V DC	CR-U220DC3L	1SVR405622R9100									
24 V AC	CR-U024AC3L	1SVR405622R0100									
48 V AC	CR-U048AC3L	1SVR405622R5100									
110 V AC	CR-U110AC3L	1SVR405622R7100									
120 V AC	CR-U120AC3L	1SVR405622R2100									
230 V AC	CR-U230AC3L	1SVR405622R3100									



2CDC 291 007 50011

CR-U2S

Ordering details - Accessories

Version	Type	Order code	Price	Pkg qty	Weight (1 pce) kg (lb)
Socket for 2 c/o and module	CR-U2S	1SVR405670R0000		10	
Socket for 3 c/o and module	CR-U3S	1SVR405660R0000			
Socket for 3 c/o	CR-U3E	1SVR405660R0100			
Socket small for 2 c/o	CR-U2SM	1SVR405670R1100			
Socket small for 3 c/o	CR-U3SM	1SVR405660R1100			
Holder for CR-U socket	CR-UH	1SVR405669R0000			

Pluggable interface relays

Ordering details - CR-U accessories



CR-U...

2CDC291.004.53011

Ordering details - CR-U range (all products stocked)

Rated control supply voltage	Description	Version	Type	Order code	Price	Pkg qty	Weight (1 pce)
							kg (lb)
6-220 V DC	Diode - Reverse polarity protection/ free wheeling diode	A1+, A2-	CR-U 21	1SVR405661R0000		10	0.007 (0.015)
6-24 V DC	Diode and LED - Reverse polarity protection/ free wheeling diode	red, A1+, A2-	CR-U 41	1SVR405662R0000		10	0.007 (0.015)
24-60 V DC		green, A1+, A2-	CR-U 41V	1SVR405662R1000			
110 V DC		red, A1+, A2-	CR-U 41B	1SVR405662R4000			
		green, A1+, A2-	CR-U 41BV	1SVR405662R4100			
6-24 V AC/DC	Spark quenching	red, A1+, A2-	CR-U 41C	1SVR405662R9000		10	0.007 (0.015)
24-60 V AC/DC		green, A1+, A2-	CR-U 41CV	1SVR405662R9100			
110-230 V AC/DC			CR-U 51B	1SVR405663R0000			
6-24 V AC/DC	Diode and LED	red, for DC A1+, A2-	CR-U 61	1SVR405664R0000		10	0.007 (0.015)
		green, for DC A1+, A2-	CR-U 61V	1SVR405664R1000			
		24-60 V AC/DC	red, for DC A1+, A2-	CR-U 61E			
110 V DC 110-230 V AC	Diode and LED	green, for DC A1+, A2-	CR-U 61EV	1SVR405664R4100		10	0.007 (0.015)
		red, for DC A1+, A2-	CR-U 91	1SVR405664R0100			
6-24 V AC/DC	Diode and LED	green, for DC A1+, A2-	CR-U 91V	1SVR405664R1100		10	0.007 (0.015)
		red, for DC A1+, A2-	CR-U 61C	1SVR405665R0000			
24-60 V AC/DC	Varistor and LED Overvoltage protection	green, for DC A1+, A2-	CR-U 61CV	1SVR405665R1000		10	0.007 (0.015)
		red, for DC A1+, A2-	CR-U 61D	1SVR405665R4000			
110 V DC 110-230 V AC	Varistor and LED Overvoltage protection	green, for DC A1+, A2-	CR-U 61DV	1SVR405665R4100		10	0.007 (0.015)
		red, for DC A1+, A2-	CR-U 91C	1SVR405665R0100			
24 V AC 115 V AC 230 V AC	Overvoltage protection, varistor	green, for DC A1+, A2-	CR-U 91CV	1SVR405665R1100		10	0.007 (0.015)
			CR-U 71	1SVR405666R0000			
			CR-U 71A	1SVR405666R1000			
24-240 V AC/DC	Multifunction time module		CR-U 81	1SVR405666R2000		10	0.014 (0.031)
			CR-U T	1SVR405667R0000			



CR-U T

2CDC291.032.F0005

Connection diagrams

All CR-U modules can be plugged onto sockets CR-U2S and CR-U3S.

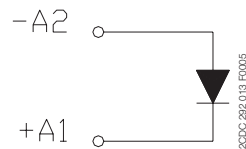

CR-U 21

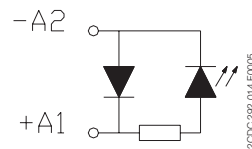

CR-U 41, CR-U 41B, CR-U 41C,
CR-U 41V, CR-U 41BV, CR-U 41CV

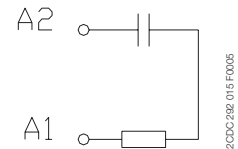

CR-U 51B, CR-U 51C CR-U 51D

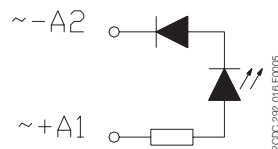

CR-U 61, CR-U 61E, CR-U 91,
CR-U 61V, CR-U 61EV, CR-U 91V

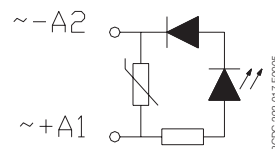

CR-U 61C, CR-U 61CV, CR-U 61D,
CR-U 61DV, CR-U 91C, CR-U 91CV

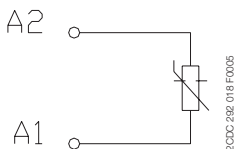

CR-U 71, CR-U 71A , CR-U 81

Pluggable interface relays

Technical data - CR-P, CR-M, CR-U

Input circuit - coil data CR-P range



	Rated control supply voltage U_s	Rated frequency	Make voltage (at 20 °C)	Maximum-voltage (at 55 °C)	Break voltage	Rated power	Coil resistance (at 20 °C)	Tolerance of coil resistance
DC coils	12 V DC	-	8.4 V DC	30.6 V DC	$\geq 0.1 U_s$	0.4-0.48 W	360 Ω	$\pm 10\%$
	24 V DC	-	16.8 V DC	61.2 V DC	$\geq 0.1 U_s$	0.4-0.48 W	1440 Ω	$\pm 10\%$
	48 V DC	-	33.6 V DC	122.4 V DC	$\geq 0.1 U_s$	0.4-0.48 W	5700 Ω	$\pm 10\%$
	110 V DC	-	77 V DC	280 V DC	$\geq 0.1 U_s$	0.4-0.48 W	25200 Ω	$\pm 10\%$
AC coils	24 V AC	50 / 60 Hz	19.2 V AC	28.8 V AC	$\geq 0.15 U_s$	0.75 VA	400 Ω	$\pm 10\%$
	48 V AC	50 / 60 Hz	38.4 V AC	57.6 V AC	$\geq 0.15 U_s$	0.75 VA	1550 Ω	$\pm 10\%$
	110 V AC	50 / 60 Hz	88 V AC	132 V AC	$\geq 0.15 U_s$	0.75 VA	8900 Ω	$\pm 10\%$
	120 V AC	50 / 60 Hz	96 V AC	144 V AC	$\geq 0.15 U_s$	0.75 VA	10200 Ω	$\pm 10\%$
	230 V AC	50 / 60 Hz	184 V AC	276 V AC	$\geq 0.15 U_s$	0.75 VA	38500 Ω	$\pm 10\%$

CR-M range



	Rated control supply voltage U_s	Rated frequency	Make voltage (at 20 °C)	Maximum voltage (at 55 °C)	Break voltage	Rated power	Coil resistance (at 20 °C)	Tolerance of coil resistance
DC coils	12 V DC	-	9.6 V DC	13.2 V DC	$\geq 0.1 U_s$	0.9 W	160 Ω	$\pm 10\%$
	24 V DC	-	19.2 DC	26.4 V DC	$\geq 0.1 U_s$	0.9 W	640 Ω	$\pm 10\%$
	48 V DC	-	38.4 V DC	52.8 V DC	$\geq 0.1 U_s$	0.9 W	2600 Ω	$\pm 10\%$
	60 V DC	-	48 V DC	66 V DC	$\geq 0.1 U_s$	0.9 W	4000 Ω	$\pm 10\%$
	110 V DC	-	88 V DC	121 V DC	$\geq 0.1 U_s$	0.9 W	13600 Ω	$\pm 10\%$
	125 V DC	-	100 V DC	137.5 V DC	$\geq 0.1 U_s$	0.9 W	16000 Ω	$\pm 10\%$
	220 V DC	-	176 V DC	242 V DC	$\geq 0.1 U_s$	0.9 W	54000 Ω	$\pm 10\%$
	AC coils	24 V AC	50 / 60 Hz	19.2 V AC	26.4 V AC	$\geq 0.2 U_s$	1.6 VA	158 Ω
48 V AC		50 / 60 Hz	38.4 V AC	52.8 V AC	$\geq 0.2 U_s$	1.6 VA	640 Ω	$\pm 10\%$
60 V AC		50 / 60 Hz	48 V AC	66 V AC	$\geq 0.2 U_s$	1.6 VA	930 Ω	$\pm 10\%$
110 V AC		50 / 60 Hz	88 V AC	121 V AC	$\geq 0.2 U_s$	1.6 VA	3450 Ω	$\pm 10\%$
120 V AC		50 / 60 Hz	96 V AC	132 V AC	$\geq 0.2 U_s$	1.6 VA	3770 Ω	$\pm 10\%$
230 V AC		50 / 60 Hz	184 V AC	253 V AC	$\geq 0.2 U_s$	1.6 VA	16100 Ω	$\pm 10\%$

CR-U range



	Rated control supply voltage U_s	Rated frequency	Make voltage (at 20 °C)	Maximum voltage (at 55 °C)	Break voltage	Rated power	Coil resistance (at 20 °C)	Tolerance of coil resistance
DC coils	12 V DC	-	9.6 V DC	13.2 V DC	$\geq 0.1 U_s$	1.5 W	110 Ω	$\pm 10\%$
	24 V DC	-	19.2 V DC	26.4 V DC	$\geq 0.1 U_s$	1.5 W	430 Ω	$\pm 10\%$
	48 V DC	-	38.4 V DC	52.8 V DC	$\geq 0.1 U_s$	1.5 W	1750 Ω	$\pm 10\%$
	110 V DC	-	88.0 V DC	121.0 V DC	$\geq 0.1 U_s$	1.5 W	9200 Ω	$\pm 10\%$
	125 V DC	-	100 V DC	137.5 V DC	$\geq 0.1 U_s$	1.5 W	11000 Ω	$\pm 10\%$
	220 V DC	-	176.0 V DC	242.0 V DC	$\geq 0.1 U_s$	1.5 W	37000 Ω	$\pm 10\%$
AC coils	24 V AC	50 / 60 Hz	19.2 V AC	26.4 V AC	$\geq 0.15 U_s$	2.8 VA (50 Hz) 2.5 VA (60 Hz)	75 Ω	$\pm 10\%$
	48 V AC	50 / 60 Hz	38.4 V AC	52.8 V AC	$\geq 0.15 U_s$	2.8 VA (50 Hz) 2.5 VA (60 Hz)	305 Ω	$\pm 10\%$
	60 V AC	50 / 60 Hz	48.0 V AC	66.0 V AC	$\geq 0.15 U_s$	2.8 VA (50 Hz) 2.5 VA (60 Hz)	475 Ω	$\pm 10\%$
	110 V AC	50 / 60 Hz	88.0 V AC	121.0 V AC	$\geq 0.15 U_s$	2.8 VA (50 Hz) 2.5 VA (60 Hz)	1700 Ω	$\pm 10\%$
	120 V AC	50 / 60 Hz	96.0 V AC	132.0 V AC	$\geq 0.15 U_s$	2.8 VA (50 Hz) 2.5 VA (60 Hz)	1910 Ω	$\pm 10\%$
	230 V AC	50 / 60 Hz	184.0 V AC	253.0 V AC	$\geq 0.15 U_s$	2.8 VA (50 Hz) 2.5 VA (60 Hz)	7080 Ω	$\pm 10\%$

Pluggable interface relays

Technical data - CR-P, CR-M, CR-U

Type		CR-P...1	CR-P...2	CR-M...2	CR-M...3	CR-M...4	CR-U...2	CR-U...3
Output circuit(s)		11-12/14	11-12/14 21-22/24	11-12/14 21-22/24	11-12/14 21-22/24 31-32/34	11-12/14 21-22/24 31-32/34 41-42/44	11-12/14 31-32/34	11-12/14 21-22/24 31-32/34
Kind of output		Relay, 1 c/o	Relay, 2 c/o	Relay, 2 c/o	Relay, 3 c/o	Relay, 4 c/o	Relay, 2 c/o	Relay, 3 c/o
Contact material		AgNi	AgNi AgNi/Au 5 µm	AgNi	AgNi	AgNi AgNi/Au 5 µm	AgNi	
Rated operational voltage U _e (VDE 0110, IEC 60947-1)		250 V						
Minimum switching voltage		5 V		10 V (AgNi)		5 V (AgNi/Au)	10 V	
Maximum switching voltage	DC	300 V DC		250 V DC				
	AC	440 V AC		250 V AC			440 V AC	
Minimum switching current		5 mA (AgNi), 2 mA (AgNi/Au)		5 mA (AgNi)	5 mA (AgNi)	2 mA (AgNi/Au)	5 mA	
Rated free air thermal current I _{th}		16 A	8 A	12 A	10 A	6 A	10 A	
Rated operational current (IEC 60947-5-1)	AC-12 (resistive) 230 V	16 A	8 A	12 A	10 A	6 A	10 A	
	AC-15 (inductive) 230 V	1.5 A	1.5 A	1.5 A	1.5 A	1 A	1.5 A	
	AC-15 (inductive) 120 V	3 A				1.5 A	3 A	
	DC-12 (resistive) 24 V	16 A	8 A	12 A	10 A	6 A	10 A	
	DC-13 (inductive) 24 V	2.5 A	2 A	2.5 A	2.5 A	2 A	2 A	
	DC-13 (inductive) 120 V	0.22 A						
	DC-13 (inductive) 250 V	0.1 A						
AC rating (UL 508)	Utilization category (pilot duty) (Contact rating code designation)	B300		B300			B300	
	max. rated operational voltage	300 V AC		300 V AC			300 V AC	
	Max. continuous thermal current at utilization category	5 A		5 A	5 A	2.5 A	5 A	
	Max. making / breaking apparent power at utilization category	3600 / 360 VA		3600 / 360 VA		1800 / 180 VA	3600/360 VA	
	Utilization category (resistive) (CSA22.2 No.14...)	16 A, 250 V AC	8 A, 250 V AC	10 A, 250 V AC 12 A, 150 V AC	6 A, 250 V AC 10 A, 150 V AC	5 A, 250 V AC 10 A, 150 V AC	10 A, 250 V AC (resistive + single-phase)	
DC rating * (UL 508; NEMA ICS-5)	Utilization category (pilot duty) (Contact rating code designation)	R300						
	Max. rated operational voltage	300 V DC						
	Max. continuous thermal current at utilization category	1 A						
	Max. making / breaking apparent power at utilization category	28 VA						
	Utilization category (resistive) (CSA22.2 No.14...)	-	10 A, 24 V DC	-			10 A, 28 V DC	
Maximum making (inrush) current		30 A	15 A	24 A	20 A	12 A	20 A	
Minimum switching power		0.3 W (AgNi), 0.05 W (AgNi/Au)		0.3 W (AgNi), 0.1 W (AgNi/Au)			0.3 W	
Maximum switching (breaking) power	AC1 (resistive)	4000 VA	2000 VA	3000 VA	2500 VA	1500 VA	2500 VA	
Contact resistance		≤ 100 mΩ						
Maximum operating frequency	rated load AC-1	600 switching cycles/h		1200 switching cycles/h				
	without load	72000 switching cycles/h		18000 switching cycles/h			12000 switching cycles/h	
Mechanical lifetime		> 3 x 10 ⁷ switching cycles		> 2 x 10 ⁷ switching cycles				
Electrical lifetime	electrical AC1 (resistive)	> 0.7 x 10 ⁵ switching cycles (16 A, 250 V)	> 10 ⁵ switching cycles (8 A, 250 V)	> 10 ⁵ switching cycles (12 A, 250 V)	> 10 ⁵ switching cycles (10 A, 250 V)	> 10 ⁵ switching cycles (6 A, 250 V)	> 10 ⁵ switching cycles (12 A, 250 V)	
	cos φ	see reduction factor F						
Response time		typ. 7 ms		typ. 13 ms (DC), 10 ms (AC)			typ. 18 ms (DC), 12 ms (AC)	
Release time		typ. 3 ms		typ. 3 ms (DC), 8 ms (AC)			typ. 7 ms (DC), 10 ms (AC)	
Isolation data								
Rated insulation voltage		400 V AC		250 V AC				
Insulation class		C250 / B400		C250 / B250			C250	
Rated impulse withstand voltage U _{imp}	between coil and contacts	5 kV AC		2.5 kV AC				
	between open contacts	1 kV AC		1.5 kV AC				
	between c/o (SPDT) contacts	-	2.5 kV AC	2.5 kV AC		≥ 2 kV AC	2 kV AC	
Clearance between coil and contacts		≥ 10 mm		≥ 2.5 mm		≥ 1.6 mm	≥ 3 mm	
Creepage distance between coil and contacts		≥ 10 mm		≥ 4 mm		≥ 3.2 mm	≥ 4.2 mm	
Overvoltage category		III		III		II	III	
Pollution degree		3		3		2	3	

* Those ratings are based on different type tests but they are not covered by the cULus or CSA approvals.

Pluggable interface relays

Technical data, load limit curves - CR-P, CR-M, CR-U

Type	CR-P...1	CR-P...2	CR-M...2	CR-M...3	CR-M...4	CR-U...2	CR-U...3
General data							
Dimensions (W x H x D) when mounted	12.7 x 29 x 15.7 mm		21.2 x 27.5 x 35.6 mm			35 x 35 x 54.4 mm	
Weight	14 g (0.031 lb)		35 g (0.077 lb)			83 g (0.18 lb)	
Mounting	on socket (see accessories)						
Mounting position	any						
Degree of protection	IP 67			IP 40			
Electrical connection							
Connection	by socket						
Environmental data							
Ambient temperature range	operation	DC: -40...+85 °C; AC: -40...+70 °C		DC: -40...+70 °C; AC: -40...+55 °C			
	storage	-40 ... +85 °C					
Vibration resistance 10-150 Hz	n/o contact	10 g		5 g		5 g	
	n/c contact	10 g	5 g	5 g	5 g		
Shock resistance	n/o contact	30 g	20 g	10 g	10 g		
	n/c contact	30 g	20 g	5 g	10 g		
Standards							
Product standard	IEC/EN 60255-23, IEC/EN 60664-1, IEC/EN 61810-1			IEC/EN 60255-23, IEC/EN 60810-1, IEC/EN 61810-7		IEC/EN 60255-1	
Low Voltage Directive	2006/95/EC						

Approvals see page 5/6.

Load limit curves - Maximum switching power at resistive DC load

CR-P with 1 c/o contact

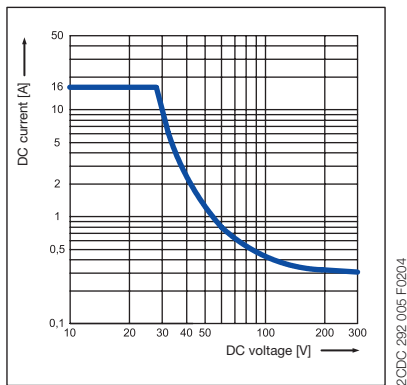

CR-P with 2 c/o contacts

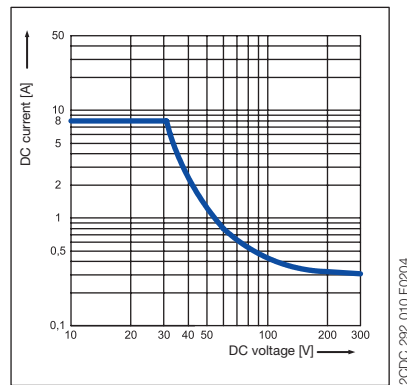

CR-U with 2 and 3 c/o contacts

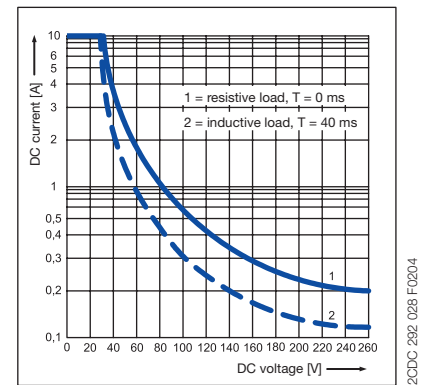

CR-M with 2 c/o contacts

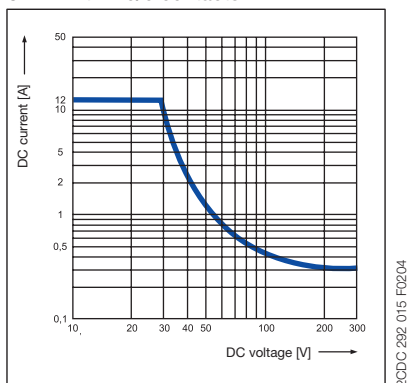

CR-M with 3 c/o contacts

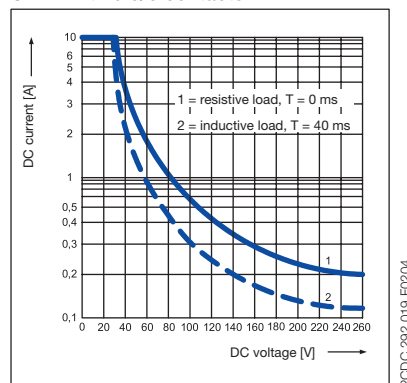

CR-M with 4 c/o contacts

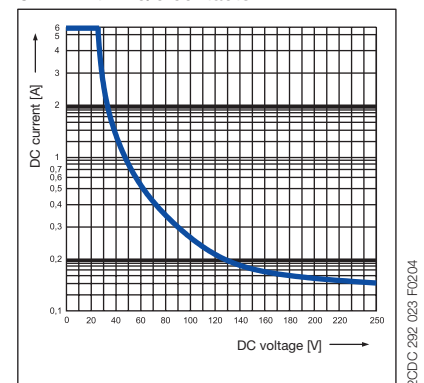

Pluggable interface relays

Technical data - Sockets for CR-P and CR-M

Output circuits		CR-PLS	CR-PLS(x)	CR-PSS	CR-PLC	CR-MxLS	CR-MxSS	CR-MxSF	CR-MxLC
Output circuits		11-12/14, 21-22/24				11-12/14, 21-22/24, ...			
Number of poles		2				2, 3 or 4		2 or 4	
Rated voltage		250 V AC	300 V AC	250 V AC	250 V AC			300 V AC	
Rated current		2 x 10 A ¹⁾	2 x 12 A ¹⁾	2 x 10 A ¹⁾	7 A			10 A	
General data									
Dimensions without holder and module (L x W x H)		76 x 15.8 x 62 mm (2.992 x 0.622 x 2.441 in)	78.5 x 15.5 x 61 mm (3.011 x 0.610 x 2.402 in)	76 x 15.8 x 42.8 mm (2.992 x 0.622 x 1.685 in)	97.5 x 16.3 x 45.2 mm (3.839 x 0.642 x 1.780 in)	75 x 27.2 x 60.8 mm (2.952 x 1.071 x 2.394 in)	75.2 x 27.2 x 42.6 mm (2.961 x 1.071 x 1.677 in)	66.7 x 30.3 x 29 mm (2.626 x 1.193 x 1.142 in)	95 x 31 x 42.5 mm (3.74 x 1.22 x 1.67 in)
Degree of protection		IP 20 B (EN 60529)							
Temperature range		operation -40...+70 °C		-40...+85 °C		-40...+70 °C		-40...+70 °C	
		storage -40...+70 °C		-40...+85 °C		-40...+70 °C		-25...+85 °C	
Connection type		screw connection			spring connection	screw connection		fork type screw	spring connection
Maximum number of wires per connecting terminal		2			2 (one per connection point)	2		-	2 (one per connection point)
Wire size		rigid			-	2 x 2.5 mm ² (2 x 14 AWG)		2 x 1.5 mm ² (2 x 16 AWG)	0.2 - 1.5 mm ² (24 x 16 AWG)
		fine-strand			0.2-1.5 mm ² (24-16 AWG)	-		-	-
		with wire end ferrule			-	2 x 1.5 mm ² (2 x 16 AWG)		-	-
Stripping length		-			-	7 mm (0.28 in)		-	-
Tightening torque		0.6 Nm	0.8 Nm	0.6 Nm	0.6 Nm (5.31 lb.in)				
Maximum clamping force		with 0.2 mm ²		-	10 N	-			
		with 1.5 mm ²		-	40 N	-			
		with wire end ferrule		-	-	-			
Mounting		DIN rail (IEC/EN 60715)							
Material		socket PA 6+GF - V2			PA 6+GF - V2				
		contacts CuZn33			CuZn33				
		contact surface 5 μ Ni		5 μ tinned	5 μ Ni	5 μ Ni		6 μ Ni	5 μ tinned
		terminals 8 μ Ni		8 μ galvanized	8 μ Ni	XCrNi Steel	8 μ Ni		CCSC
		combi screw M3		8.8 Steel, 5μ Ni	-	8.8 Steel, 5μ Ni			
Isolation data									
Insulation voltage		> 5 kV	> 3 kV	> 5 kV	> 3 kV		> 4 kV		
Isolation between coil and contacts		EN 61984			VDE 0106 / 101	EN 61984		-	DIN EN 61140, VDE 0140-1
Clearance and creepage distance		EN 61984			DIN EN 60664-1	EN 61984		DIN EN 60664-1	
Standards									
Products standard		EN 61984			EN 61984		-		
Low Voltage Directive		2006/95/EC			2006/95/EC		-		
EMC Directive		-			2004/108/EC		-		

¹⁾ Loads >10 A (>12 A for CR-PLSx) require jumpering of terminal 11 with 21, 12 with 22, and 14 with 24

Pluggable interface relays

Technical data - Sockets for CR-U

Output circuits	CR-U2S	CR-U3S	CR-U3E	CR-UxSM
Output circuits	11-12/14, 21-22/24,...			
Number of poles	2	3		2 or 3
Rated voltage	250 V AC		300 V AC	250 V
Rated current	10 A			
General data				
Dimensions without holder and module (L x W x H)	75.3 x 37.3 x 26 mm (2.965 x 1.469 x 1.024 in)	75.3 x 38.1 x 26 mm (2.965 x 1.500 x 1.024 in)	70 x 38 x 26 mm (2.756 x 1.496 x 1.024 in)	61.8 x 38.1 x 26 mm (2.756 x 1.500 x 1.024 in)
Degree of protection	IP 20 B (EN 60529)			
Temperature range				
operation	-40...+70 °C		-40...+85 °C	-40...+70 °C
storage	-40...+70 °C		-40...+85 °C	-40...+70 °C
Wire size				
rigid	2 x 2.5 mm ² (2 x 14 AWG)			
fine-strand	2 x 2.5 mm ² (2 x 14 AWG)			
with wire end ferule	2 x 1.5 mm ² (2 x 16 AWG)			
Tightening torque	0.6 Nm		0.8 Nm	0.6 Nm
Mounting	DIN rail (IEC/EN 60715)			
Material				
socket	PA 6+GF - V2			
contacts	CuZn33			
contact surface	6 μ Ni			3 μ Ni
terminals	8 μ Ni		8 μ galvanized	10 μ Ni
combi screw M3	8.8 Steel, 5μ Ni			Steel, 8 μ Ni
Isolation data				
Insulation voltage	> 2 kV			
Isolation between coil and contacts	EN 61984			
Clearance and creepage distance	EN 61984			
Standards				
Products standard	EN 61984: 2001			
Low Voltage Directive	2006/95/EC			

Pluggable interface relays

Technical data - CR-S range

	Rated control supply voltage U_s	Make voltage (at 23 °C)	Maxium voltage (at 55 °C)	Break voltage	Rated power	Coil resistance (at 23 °C)	Tolerance of coil resistance
CR-S005VDC1R(G)	5 V DC	3.75 V DC	7.5 V DC	0.25 V DC	170 mW	147 Ω	$\pm 10 \%$
CR-S012VDC1R(G)	12 V DC	9 V DC	18 V DC	0.6 V DC	170 mW	848 Ω	$\pm 10 \%$
CR-S024VDC1R(G)	24 V DC	18 V DC	36 V DC	1.2 V DC	170 mW	3390 Ω	$\pm 15 \%$
CR-S048VDC1R(G)	48 V DC	36 V DC	72 V DC	2.4 V DC	210 mW	10600 Ω	$\pm 15 \%$
CR-S060VDC1R(G)	60 V DC	45 V DC	90 V DC	3 V DC	210 mW	16600 Ω	$\pm 15 \%$

Output circuits

Output circuits	11-12/14	
Kind of output	1 c/o (SPDT)	
Contact material	AgSnO ₂ / AgSnO ₂ /Au	
Rated operational voltage U_g (IEC/EN 60947-1)	250 V AC	
Minimum switching voltage	12 V DC	
Maximum switching voltage	400 V AC / 125 V DC	
Minimum switching current	100 mA (AgSnO ₂) / 10 mA (AgSnO ₂ /Au)	
Rated free air thermal current I_{th}	5 A	
Rated operational current (IEC/EN 60947-5-1)	AC12 (resistive)	230 V 6 A
	AC15 (inductive)	230 V 1.5 A
	AC15 (inductive)	120 V 3 A
	DC12 (resistive)	24 V 6 A
	DC13 (inductive)	24 V 1 A
	DC13 (inductive)	120 V 0.22 A
	DC13 (inductive)	250 V 0.11 A
AC rating (UL 508; NEMA ICS-5)	Utilization category (pilot duty) (Contact rating code designation)	B300
DC rating (UL 508; NEMA ICS-5)	Utilization category (pilot duty) (Contact rating code designation)	R300
Maximum making (inrush) current	15 A, 240 V AC	
Minimum switching power	100 mA/12 V (AgSnO ₂) / 50 mW (AgSnO ₂ /Au)	
Maximum switching (breaking) power	AC1 (resistive)	1500 VA, 250 V AC
Contact resistance	100 m Ω (at 1 A/ 6 V DC)	
Maximum operating frequency	rated load AC1	360 switching cycles/h
	without load	18000 switching cycles/h
Mechanical lifetime	1 x 10 ⁷ switching cycles	
Electrical lifetime	AC1 (resistive)	(n/c) 3 x 10 ⁴ switching cycles (at +85 °C)
		(n/o) 1 x 10 ⁴ switching cycles (at +85 °C)
Response time	8 ms	
Release time	4 ms	
Isolation data		
Rated insulation voltage	250 V AC	
Rated impulse withstand voltage U_{imp}	between coil and contacts	4000 V AC 1 min
	between open contacts	1000 V AC 1 min
Clearance	between coil and contacts	5.5 mm (0.217 in)
Creepage distance	between coil and contacts	8 mm (0.315 in)
Overvoltage category	III	
Pollution degree	2	
General data		
Dimensions (W x H x D)	28 x 5 x 15 mm (1.102 x 0.196 x 0.590 in)	
Weight	5 g (0.011 lb)	
Mounting	on socket	
Mounting position	any	
Degree of protection	RT II and RT III	
Electrical connection		
Connection	by socket	
Environmental data		
Ambient temperature range	operation	-40...+85 °C
	storage	0...+40 °C
Vibration resistance (10-150 Hz)	n/o contact	10 Hz to 55 Hz 1mm DA
	n/c contact	10 Hz to 55 Hz 1mm DA
Shock resistance	n/o contact	Functional 49 m/s ² / Destructive 980 m/s ²
	n/c contact	Functional 49 m/s ² / Destructive 980 m/s ²
Standards		
Product standard	IEC 61810-1	
Low Voltage Directive	2006/95/EC	

Pluggable interface relays

Technical data - CR-S range sockets

Input circuits	CR-S 6-24 V	CR-S 12-24 V	CR-S 48-60 V	CR-S 110-125 V	CR-S 220-240 V
Rated control supply voltage U_s	6-24 V DC	2-24 V AC/DC	48-60 V AC/DC	110-125 V AC/DC	220-240 V AC/DC
Rated control supply voltage U_s tolerance	(0.8-1.2) U_n	(0.8-1.1) U_n			
Typical current	11-29 mA	11-16 mA	3.6-4.5 mA	3.6 mA	3.6 mA
Response time	8 ms				
Release time	4 ms				
Status device	green LED				
Protective circuit	yes				
Output circuits					
Output circuits	11-12/14				
Number of poles	1				
Rated voltage	250 V AC				
Rated current	6 A				
General data for CR-S with screw connection terminal					
Dimensions without holder (L x W x H)	88.3 x 6.3 x 70.9 mm (3.476 x 0.248 x 2.789 in)				
Degree of protection (EN 60529)	Degree of protection (EN 60529) IP20 (terminals)				
Temperature range	operation	-40...+70 °C			-40...+55 °C
	storage	0...+40 °C			
Connection type	Screw				
Maximum number of wires per connection terminal	2				
Wire size	rigid	1 x 2.5 mm ² (1 x 14 AWG) ; 2 x 1.5 mm ² (2 x 16 AWG)			
	fine-strand	1 x 2.5 mm ² (1 x 14 AWG); 2 x 1.5 mm ² (2 x 16 AWG)			
	with wire end ferule	1 x 2.5 mm ² (1 x 14 AWG); 2 x 1.0 mm ² (2 x 18 AWG)			
Tightening torque	0.5 Nm (4.426 lb.in)				
Stripping length	7 mm (0.276 in)				
Mounting (IEC/EN 60715)	DIN rail				
Material	socket	PA6 +GF-V2			
	contacts	CuZn36			
	contact surface	3 μ Ni/Sn			
	terminals	CuZn40, 3 μ Ni			
	combi screw M3	Fe			
General data for CR-S with spring connection terminal					
Dimensions without holder (L x W x H)	88.3 x 6.3 x 70.9 mm (3.476 x 0.248 x 2.789 in)				
Degree of protection (EN 60529)	Degree of protection (EN 60529) IP20 (terminals)				
Temperature range	operation	-40...+70 °C			-40...+55 °C
	storage	0...+40 °C			
Connection type	Spring				
Maximum number of wires per connection terminal	1				
Wire size	2.5 mm ² (14 AWG) rigid, fine-strand and with wire end ferule				
Stripping length	7 mm (0.276 in)				
Mounting (IEC/EN 60715)	DIN rail				
Material	socket	PA6 +GF-V2			
	contacts	CuZn36			
	contact surface	3 μ Ni/Sn			
	spring terminals	SUS301			
Isolation data					
Isolation between coil and contacts	5000 V AC				
Resistance to shock coil to contact	1000 MΩ				
Clearance and creepage distance	IEC/EN 61984				
Standards					
Product stancard	IEC/EN 61984: 2001				
Low Voltage Directive	2006/95/EC				

Load limit curves - Max. DC load breaking capacity

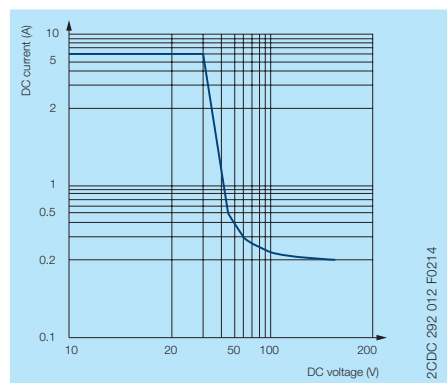

Endurance curve

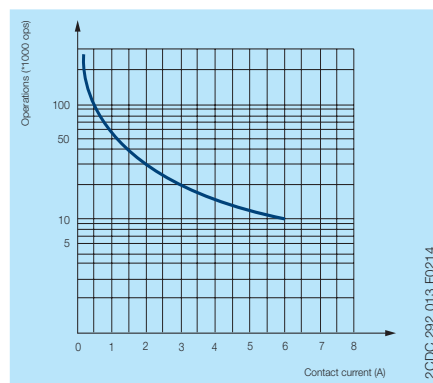

Pluggable interface relays

Load limit curves

Load limit curves - Electrical lifetime at resistive AC load

5

CR-P with 1 c/o contact

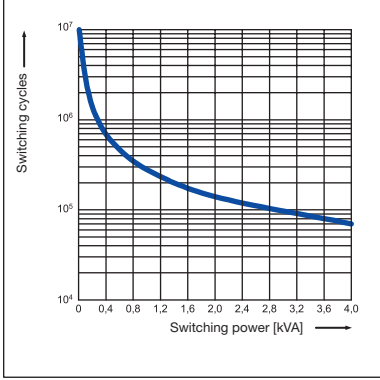

CR-P with 2 c/o contacts

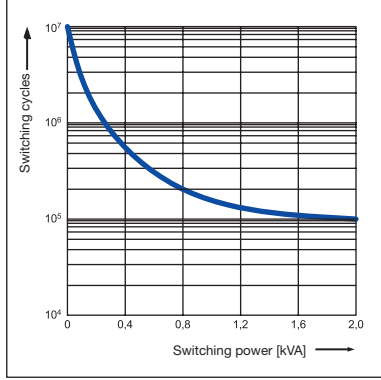

CR-U with 2 and 3 c/o contacts

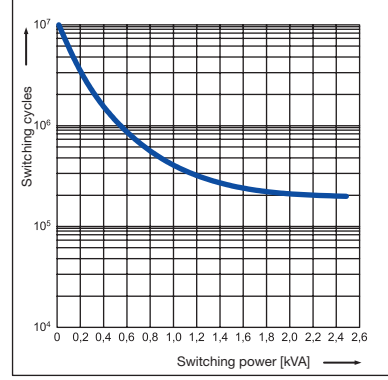

CR-M with 2 c/o contacts

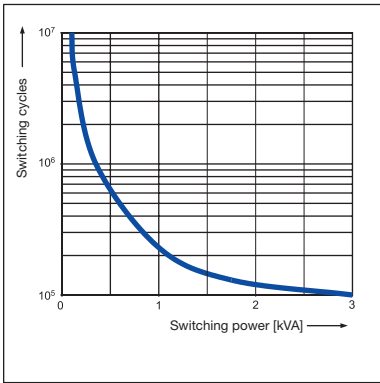

CR-M with 3 c/o contacts

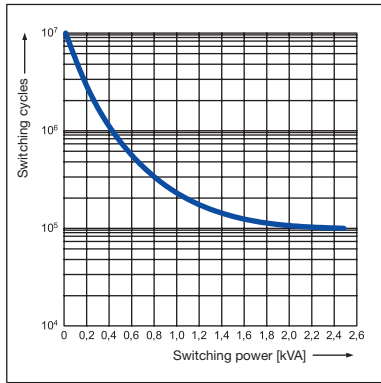

CR-M with 4 c/o contacts

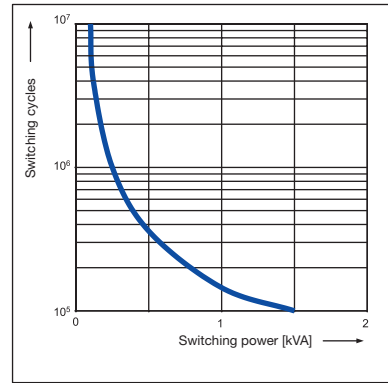

Reduction factor F at inductive AC load

CR-P

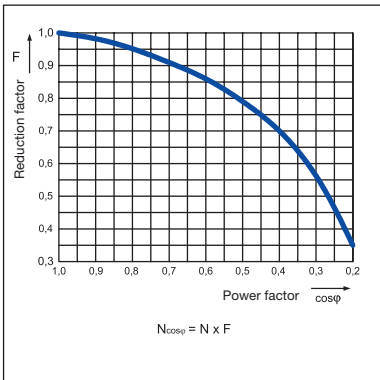

CR-M

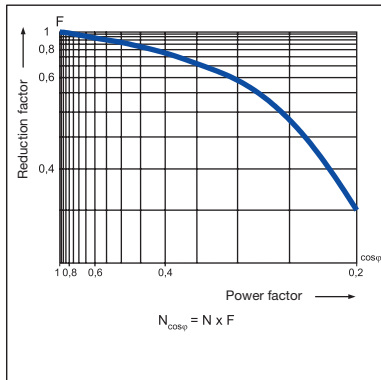

CR-U

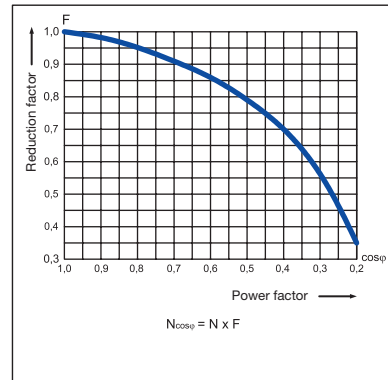

Pluggable interface relays

Connection diagrams

Connection diagrams

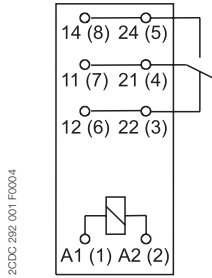

CR-P with 1 c/o contact

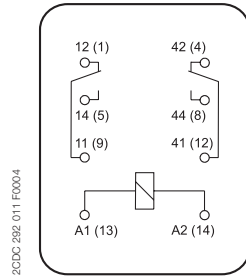

CR-M with 2 c/o contacts

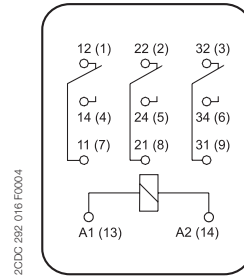

CR-M with 3 c/o contacts

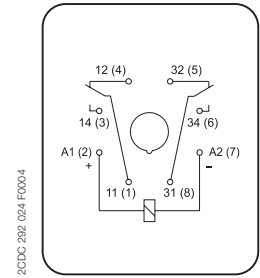

CR-U with 2 c/o contacts

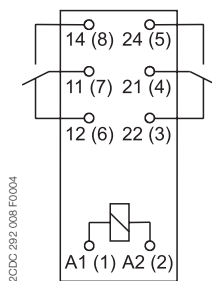

CR-P with 2 c/o contacts

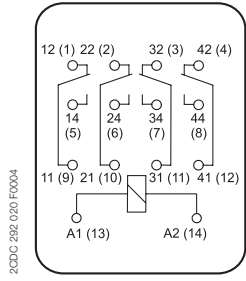

CR-M with 4 c/o contacts

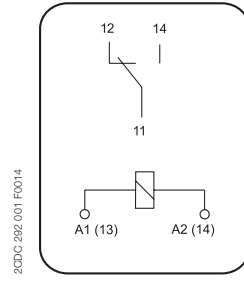

CR-S

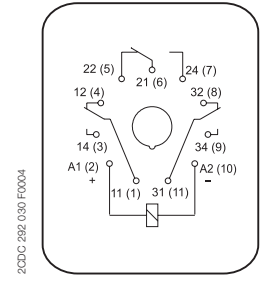

CR-U with 3 c/o contacts

Dimensional drawings Dimensions in mm and inches

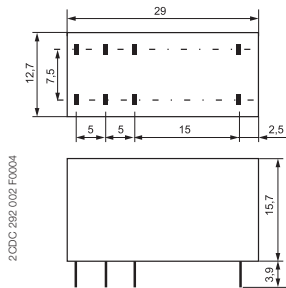

CR-P

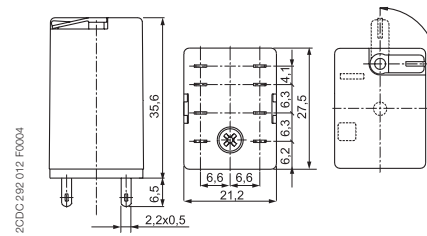

CR-M with 2 c/o contacts

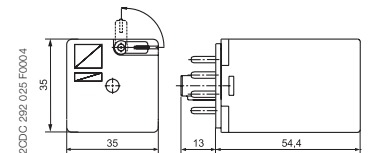

CR-U with 2 c/o contacts

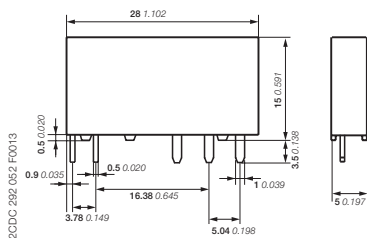

CR-S

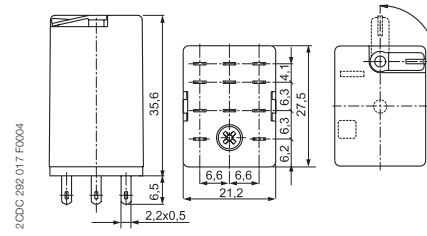

CR-M with 3 c/o contacts

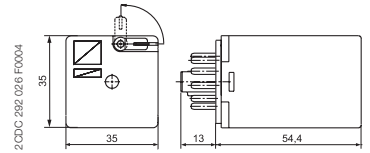

CR-U with 3 c/o contacts

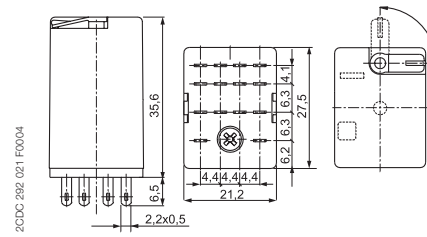

CR-M with 4 c/o contacts

Pluggable interface relays

Dimensional drawings

Dimensions in mm and inches

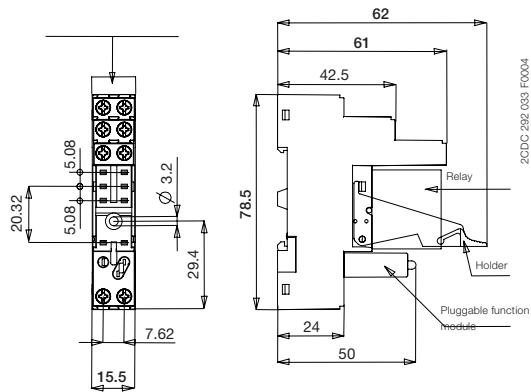
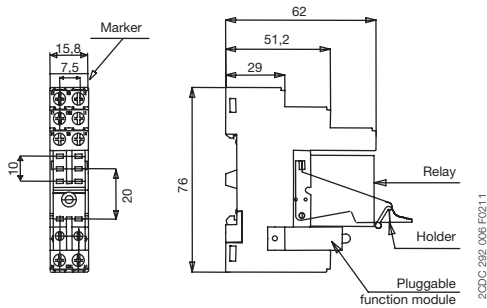

CR-PLS - screw connection

CR-PLSx - screw connection

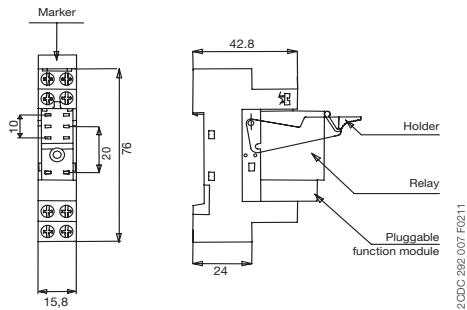

CR-PSS - screw connection

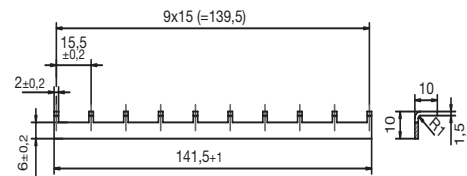

CR-PJ

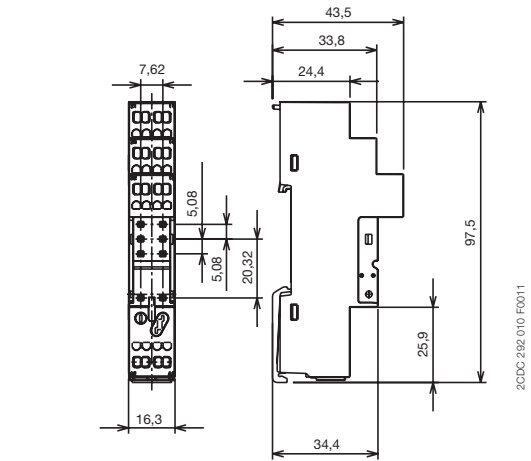

CR-PLC - spring connection

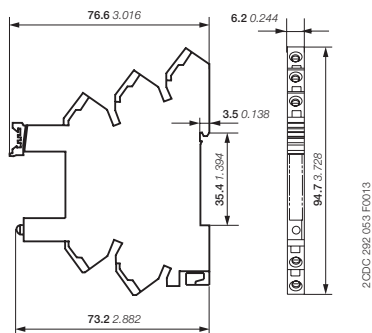

Spring socket for CR-S range interface relays

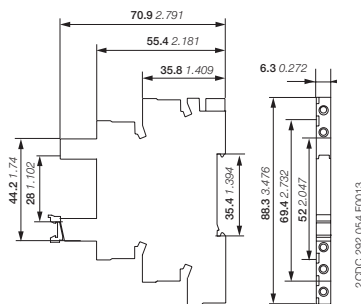

Screw socket for CR-S range interface relays

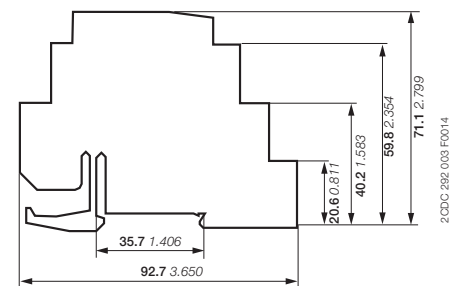

Separator for CR-S

Jumper

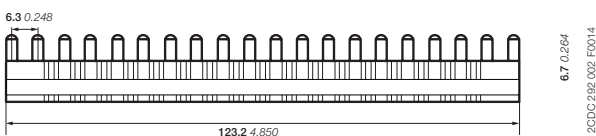

Jumper bar CR-S

Pluggable interface relays

Dimensional drawings

Dimensions in mm and inches

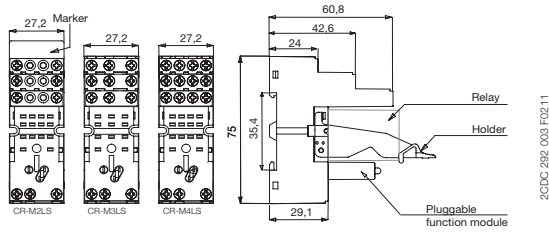

2CDC 292 003 F0211

CR-M2LS - CR-M3LS - CR-M4LS - screw connection

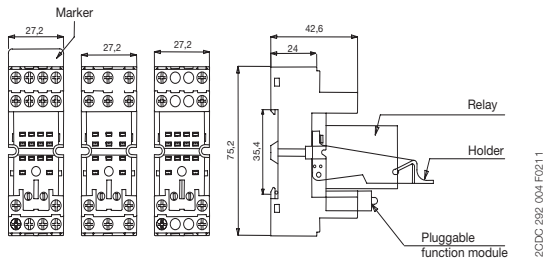

2CDC 292 004 F0211

CR-M2SS - CR-M3SS - CR-M4SS - screw connection

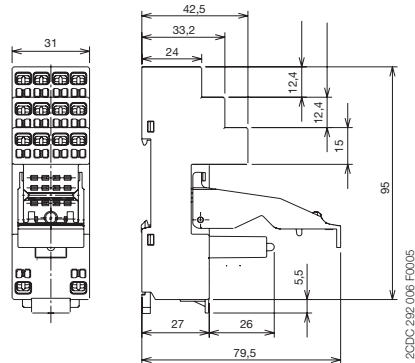

2CDC 292 006 F0005

CR-M2LC, CR-M4LC - spring connection

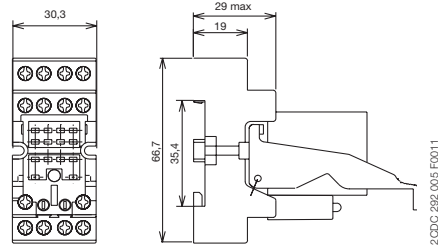

2CDC 292 005 F0011

CR-MxSF - screw connection

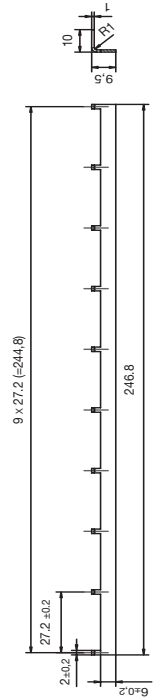

CR-MJ

2CDC 292 011 F0011

5

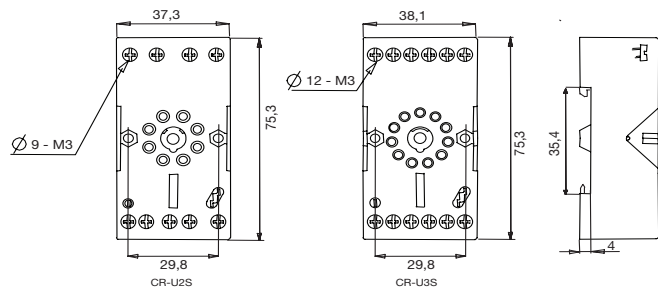

2CDC 292 008 F0011

CR-U2S - CR-U3S

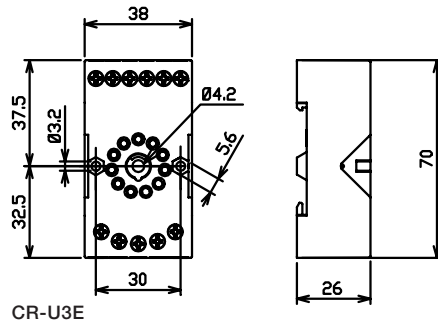

2CDC 292 081 F0004

CR-U3E

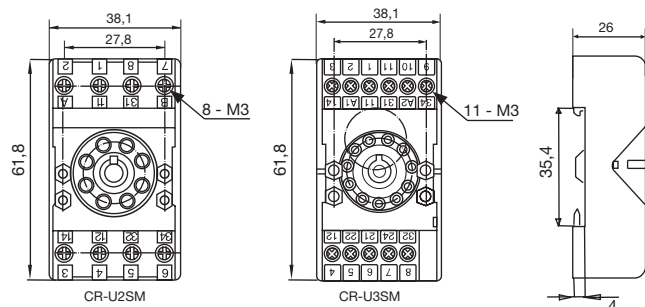

2CDC 292 009 F0011

CR-U2SM

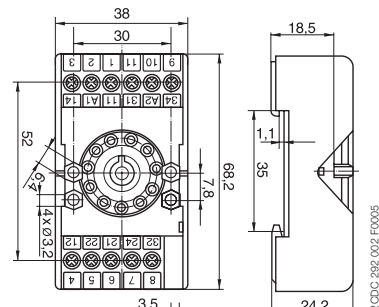

2CDC 292 002 F0005

CR-U3SM

Interface relays and optocouplers R600 range

Product group picture

5

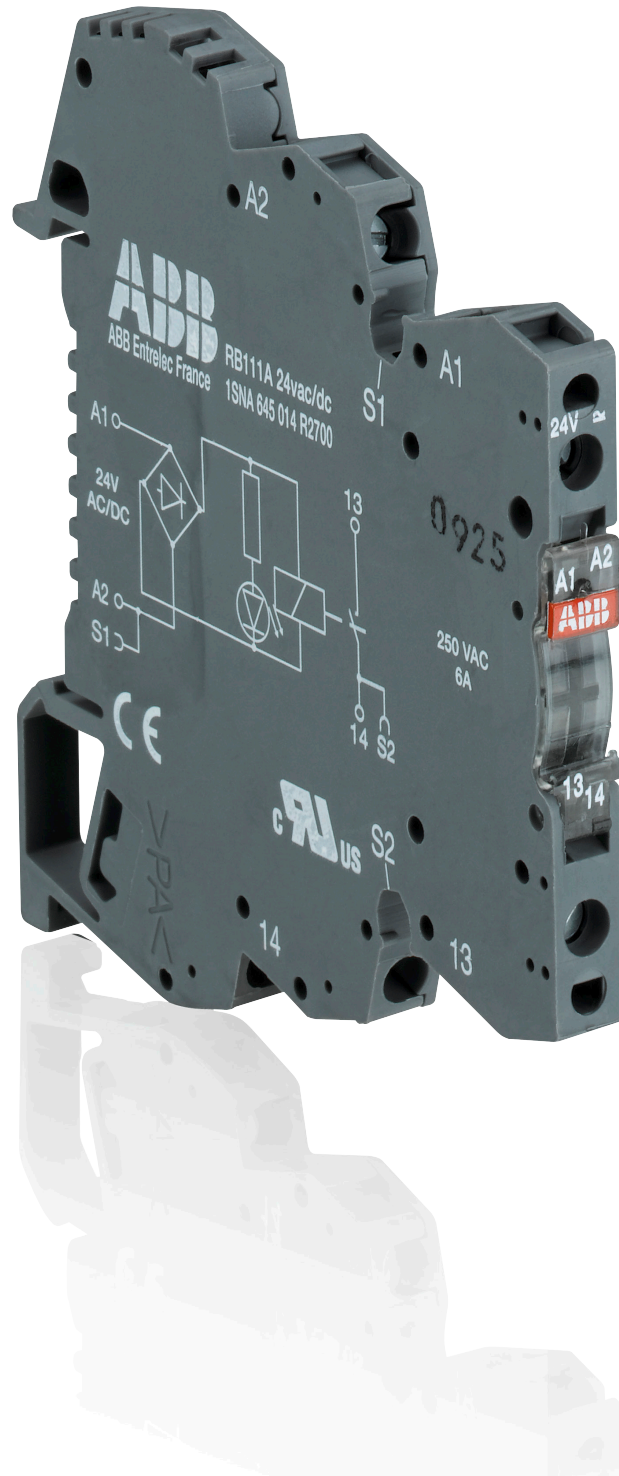

Interface relays and optocouplers R600 range

Table of contents

Interface relays and optocouplers R600 range

Benefits and advantages	5/29
Type designators	5/30
Interface relays R600 range	5/31
Benefits and advantages	5/31
Selection	5/33
Ordering details	5/35
Connection diagrams	5/37
Technical data	5/38
General technical data	5/43
Dimensional drawings, Load limit curves	5/44
Optocouplers R600 range	5/45
Selection	5/45
Ordering details	5/47
Connection diagrams	5/48
Technical data	5/49

Interface relays and optocouplers R600 range

Benefits and advantages

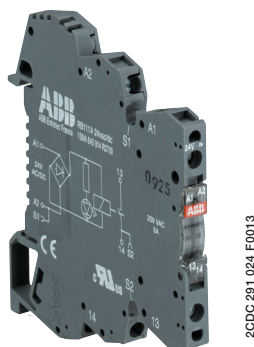

R600 series

5 Standard range in screw clamp or spring clamp versions

- Spacing : 6 mm or 12 mm
- Wire size : 2.5 mm² (4 mm² solid wire)
- Contact type : 1 NO, 1 NC, 1 SPDT, 1 DPDT from 1 mA to 8 A / 250 V

In today's automation systems, PLCs are the core of industry. They link sensors and actuators to the process, which are connected to the PLC via conventional wires.



However these PLCs are not completely isolated from the industrial environment, hence over voltage picks and transient currents can affect their operating functions. And additionally, their application field is often limited to 24 VDC / 100 mA.

So, with the aim to adapt application voltage and/or current and provide as well the right electrical isolation to the PLC, it is recommended to install per I/O the right interface providing both voltage-current level adaptation and isolation protection.

This interfacing is possible thanks to ABB's relays and optocouplers ranges, which offer wide adaptation in both voltage (from 5 to 400 V) and current (from 10-7 to 16 A) as well as high isolation between input and output from 2 to 4 KV.

Interface relays and optocouplers R600 range

Type designators

SERIES	CODE	NB OF RELAYS	CONTACT TYPE	NB OF CONTACTS PER RELAY	PARTICULARITIES
R600 screw type 	R / B	<input type="checkbox"/>	<input type="checkbox"/>	<input type="checkbox"/>	<input type="checkbox"/>
R600 spring type 	R / B / R	<input type="checkbox"/>	<input type="checkbox"/>	<input type="checkbox"/>	<input type="checkbox"/>
		1	0 1 2	1 2	None / A / R

Description of contact types

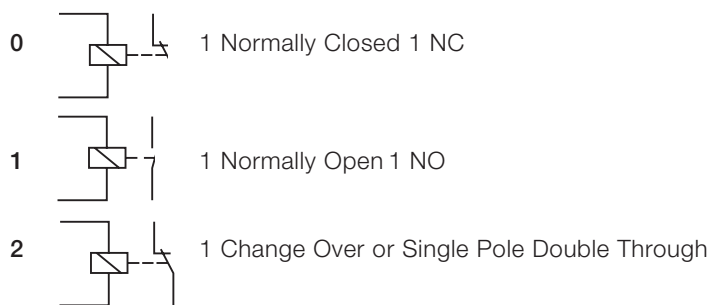

Features

None Input voltage DC
A Input voltage AC/DC

R RC circuit protection :

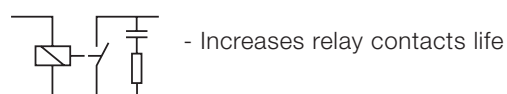
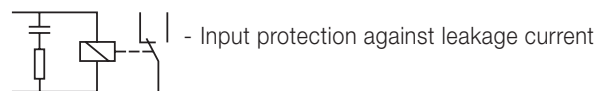

Interface relays R600 range

Benefits and advantages

Characteristics

- Standard range available with screw or spring-type terminals
- 8 different rated control supply voltages:
DC versions: 5 V, 12 V, 24 V
AC/DC versions: 24 V, 48-60 V, 115 V, 230 V, 60-230 V
- Output: 1 n/c contact, 1 n/o contact, 1 c/o (SPDT) contact, 2 c/o (SPDT) contacts
- Devices with output contacts protected by built in RC circuit, which result in increased contact life
- Devices with leakage current protection on the input side
- Available with visible or covered switch on the front of the unit, for the configuration of manual or automatic actuation
- With connection for jumper bar, except 2 c/o devices and some discontinued devices
- Width: 6 mm (0.236 in) or 12 mm (0.472 in)
- LED for the indication of the operational state
- Accessories: Jumper bars, separator end section
- Approvals / Marks

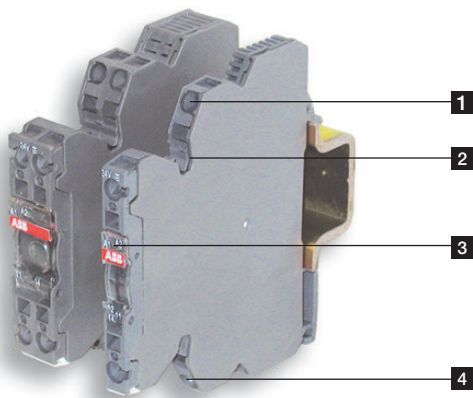

 (pending) / CE

5

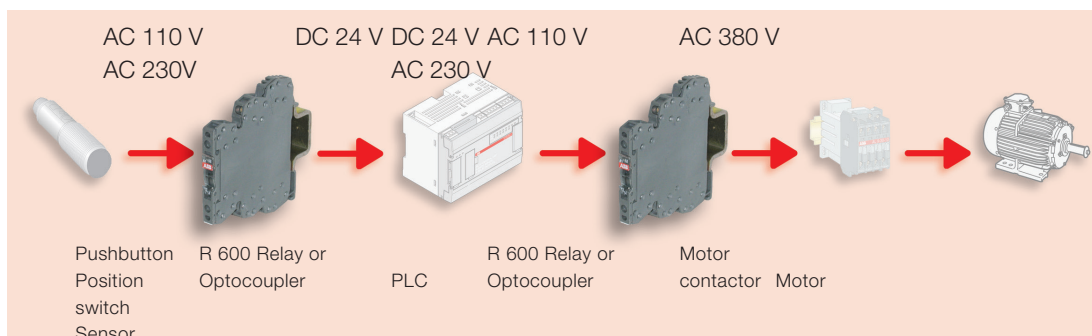

- 1** Input - Control supply voltage
- 2** Jumper bar connection
- 3** Indication of operational states (green LED)
- 4** Output

Excellent adaption and conversion of digital signals



Interface relays R600 range

Benefits and advantages

Interface relays are electromechanic and electronic input and output modules for electrical isolation, levelling, noise suppression or signal amplification between control unit and process.

Boxed interface relays are used for electrical isolation, amplification and signal matching between the electronic controlling, e.g. PLC (programmable logic controller), PC or field bus systems and the sensor / actuator level. The compact design and different connection terminal possibilities optimize your panel installation.

Increased contact life

The contacts of some devices are protected by built in RC-circuits which result in increased contact life.

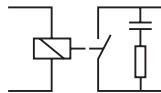

Variety of connections

R600 relays and optocouplers are available with both screw terminals or spring terminals.

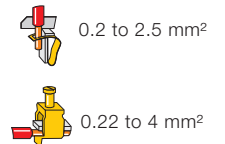

Space saving

With a width of only 6 mm or 12 mm the compact design saves space in each cabinet.

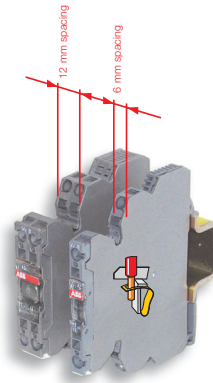

Functioning status

Functioning display through a green LED.



Only one part number AC/DC

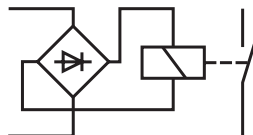

Measurement & Test

Holes for holding DIA. 2 mm test plugs to simplify any measurement or test.



Interface relays R600 range

Selection

RB 121A-115VAC/DC	1SNA645003R0500																							
RB 121A-115VAC/DC	1SNA645007R0100																							
RB 121AR-115VAC/DC	1SNA645046R0700																							
RBR 121A-115VAC/DC	1SNA645503R0700																							
RBR 121A-115VAC/DC	1SNA645507R0300																							
RBR 121AR-115VAC/DC	1SNA645546R0100																							
RB 122A-115VAC/DC	1SNA645041R0200																							
RBR 122A-115VAC/DC	1SNA645541R0400																							
RB 111A-115VAC/DC	1SNA645016R2100																							
RB 111A-230VAC/DC	1SNA645017R2200																							
RB 121A-230VAC/DC	1SNA645004R0400																							
RB 121A-230VAC/DC	1SNA645008R1200																							
RB 121AR-230VAC/DC	1SNA645011R2400																							
RBR 121A-230VAC/DC	1SNA645504R0000																							
RBR 121A-230VAC/DC	1SNA645508R1400																							
RBR 121AR-230VAC/DC	1SNA645511R2600																							
RB 122A-230VAC/DC	1SNA645013R2600																							
RBR 122A-230VAC/DC	1SNA645513R2000																							
RB 121A 60-230VUC	1SNA645020R0100																							
RBR 121A 60-230VUC	1SNA645520R0300																							

Interface relays R600 range

Ordering details



2CDC 291 024 S0013



5

R600 - 6 mm





 screw terminals

 spring terminals



Ordering details - 1 n/c contact: 250 V, 10 mA - 6 A (high level), width 12 mm

Rated control supply voltage	Particularities and connection type	Type	Order code	Price	Pkg qty	Weight (1 pce) kg (lb)
24 V AC/DC	RC circuit parallel to contact on output side	 RB101AR-24VAC/DC	1SNA645019R0400		5	0.04 (0.088)
		 RBR101AR-24VAC/DC	1SNA645519R0600			















Ordering details - 1 n/o contact: 250 V, 10 mA - 6 A (high level) width 6 mm

Rated control supply voltage	Particularities and connection type	Type	Order code	Price	Pkg qty	Weight (1 pce) kg (lb)
24 V AC/DC		 RB111A-24VAC/DC	1SNA645014R2700		10	0.02 (0.044)
115 V AC/DC		 RB111A-115VAC/DC	1SNA645016R2100			
230 V AC/DC		 RB111A-230VAC/DC	1SNA645017R2200			
24 V AC/DC		 RBR111A-24VAC/DC	1SNA645514R2100			

Ordering details - 1 n/o contact: 250 V, 10 mA - 6 A (high level), width 12 mm

Rated control supply voltage	Particularities and connection type	Type	Order code	Price	Pkg qty	Weight (1 pce) kg (lb)
24 V AC/DC	RC circuit parallel to contact on output side	 RB111AR-24VAC/DC	1SNA645018R0300		5	0.04 (0.088)
		 RBR111AR-24VAC/DC	1SNA645518R0500			

Ordering details - 1 c/o (SPDT) contact: 250 V, 1 mA - 6 A (low level), width 6 mm

Rated control supply voltage	Particularities and connection type	Type	Order code	Price	Pkg qty	Weight (1 pce) kg (lb)
5 V DC	A1-A2 polarized	 RB121-5VDC	1SNA645036R2500		10	0.02 (0.044)
12 V DC		 RB121-AU-12VDC	1SNA645075R0000			
24 V DC		 RB121-AU-24VDC	1SNA645072R0000			
24 V AC/DC		 RB121A-24VAC/DC	1SNA645005R0700			
48-60 V AC/DC		 RB121A-48-60VAC/DC	1SNA645006R0000			
115 V AC/DC		 RB121A-115VAC/DC	1SNA645007R0100			
230 V AC/DC		 RB121A-230VAC/DC	1SNA645008R1200			
5 V DC	A1-A2 polarized	 RBR121-5VDC	1SNA645536R2700			
12 V DC		 RBR121-AU-12VDC	1SNA645575R0000			
24 V DC		 RBR121-AU-24VDC	1SNA645572R0000			
24 V AC/DC		 RBR121A-24VAC/DC	1SNA645505R0100			
48-60 V AC/DC		 RBR121A-48-60VUC	1SNA645506R0200			
115 V AC/DC		 RBR121A-115VAC/DC	1SNA645507R0300			
230 V AC/DC		 RBR121A-230VAC/DC	1SNA645508R1400			

Interface relays R600 range

Ordering details



R600 - 12 mm

25DC2 291 013 S0013

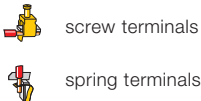

screw terminals

spring terminals

Ordering details - 1 c/o (SPDT) contact: 250 V, 10 mA - 6 A (high level), width 6 mm

Rated control supply voltage	Particularities and connection type	Type	Order code	Price	Pkg qty	Weight (1 pce) kg (lb)
5 V DC	A1-A2 polarized	RB121-5VDC	1SNA645034R2300		10	0.02 (0.044)
12 V DC	A1-A2 polarized	RB121-12VDC	1SNA645035R2400			
12 V DC		RB121-12VDC	1SNA645073R0000			
24 V DC		RB121-24VDC	1SNA645071R0000			
24 V AC/DC		RB121A-24VAC/DC	1SNA645001R0300			
48-60 V AC/DC		RB121A-48-60VAC/DC	1SNA645002R0400			
115 V AC/DC		RB121A-115VAC/DC	1SNA645003R0500			
230 V AC/DC		RB121A-230VAC/DC	1SNA645004R0400			
5 V DC	A1-A2 polarized	RBR121-5VDC	1SNA645534R2500			
12 V DC	A1-A2 polarized	RBR121-12VDC	1SNA645535R2600			
12 V DC		RBR121-12VDC	1SNA645573R0000			
24 V DC		RBR121-24VDC	1SNA645571R0000			
24 V AC/DC		RBR121A-24VAC/DC	1SNA645501R0500			
48-60 V AC/DC		RBR121A-48-60VUC	1SNA645502R0600			
115 V AC/DC		RBR121A-115VAC/DC	1SNA645503R0700			
230 V AC/DC		RBR121A-230VAC/DC	1SNA645504R0000			

Ordering details - 1 c/o (SPDT) contact: 250 V, 10 mA - 6 A (high level), width 12 mm

Rated control supply voltage	Particularities and connection type	Type	Order code	Price	Pkg qty	Weight (1 pce) kg (lb)
60-230 V AC/DC		RB121A-60-230VUC	1SNA645020R0100		5	0.04 (0.088)
115 V AC/DC	Leakage current protection, input side	RB121AR-115VAC/DC	1SNA645046R0700			
230 V AC/DC		RB121AR-230VAC/DC	1SNA645011R2400			
60-230 V AC/DC		RBR121A-60-230VUC	1SNA645520R0300			
115 V AC/DC	Leakage current protection, input side	RBR121AR-115VAC/DC	1SNA645546R0100			
230 V AC/DC		RBR121AR-230VAC/DC	1SNA645511R2600			

Ordering details - 2 c/o (SPDT) contacts: 250 V, 1 mA - 8 A (low level), width 12 mm

Rated control supply voltage	Connection type	Type	Order code	Price	Pkg qty	Weight (1 pce) kg (lb)
24 V AC/DC		RB122A-24VAC/DC	1SNA645012R2500		5	0.04 (0.088)
48-60 V AC/DC		RB122A-48-60VAC/DC	1SNA645040R1500			
115 V AC/DC		RB122A-115VAC/DC	1SNA645041R0200			
230 V AC/DC		RB122A-230VAC/DC	1SNA645013R2600			
24 V AC/DC		RBR122A-24VAC/DC	1SNA645512R2700			
48-60 V AC/DC		RBR122A-48-60VUC	1SNA645540R1700			
115 V AC/DC		RBR122A-115VAC/DC	1SNA645541R0400			
230 V AC/DC		RBR122A-230VAC/DC	1SNA645513R2000			

Ordering details - Accessories

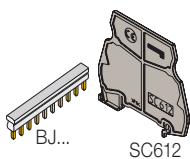

Description	Type	Order code	Price	Pkg qty	Weight (1 pce) kg (lb)
24 V AC/DC	BJ 612-10	1SNA290488R0100		10	0.05 (0.11)
48-60 V AC/DC	BJ 612-20	1SNA206754R0000			0.01 (0.022)
230 V AC/DC	SC 612	1SNA290474R0200			0.05 (0.11)

Interface relays R600 range

Connection diagrams

11-12 n/c contact
 13-14 n/o contact
 11-12/14 1st c/o contact
 21-22/24 2nd c/o contact

A1-A2 Control supply voltage
 S1 Connection for jumper bar (input side)
 S2 Connection for jumper bar (output side)

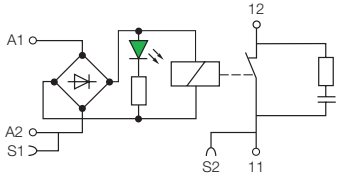

2CDC 292 030 F0013

RB/RBR 101 AR

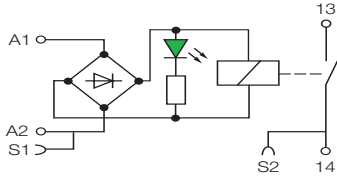

2CDC 292 031 F0013

RB/RBR 111 A - 24 V AC/DC

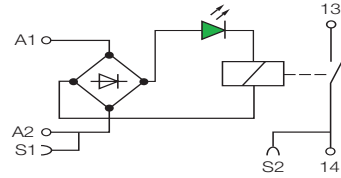

2CDC 292 038 F0013

RB/RBR 111 A - 48/60/115/230 V AC/DC

5

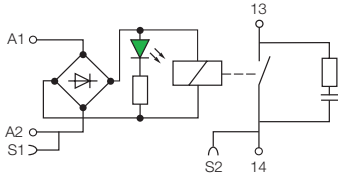

2CDC 292 035 F0013

RB/RBR 111 AR

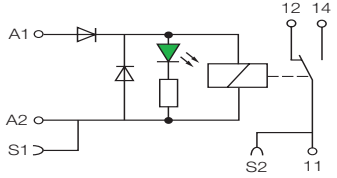

2CDC 292 036 F0013

RB/RBR 121
 - 5 V DC, A1-A2 polarized
 - 12 V DC, A1-A2 polarized, i.e. only:
 1SNA645035R2400, 1SNA645535R2600

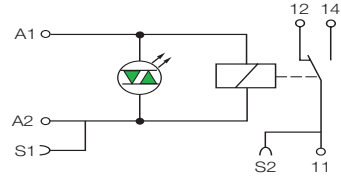

2CDC 292 038 F0013

RB/RBR 121 (AU)
 - 12/24 V DC, except:
 1SNA645035R2400, 1SNA645535R2600
 see connection diagram RB...121-5VDC

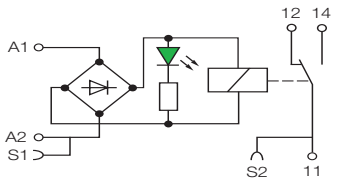

2CDC 292 039 F0013

RB/RBR 121 A - 24 V AC/DC

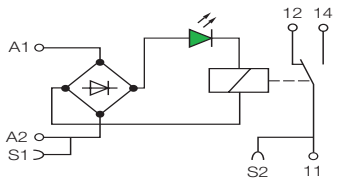

2CDC 292 040 F0013

RB/RBR 121 A - 48/60/115/230 V AC/DC

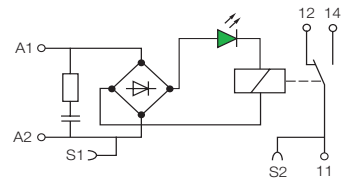

2CDC 292 042 F0013

RB/RBR 121 AR

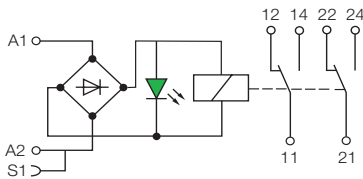

2CDC 292 043 F0013

RB/RB 122 A - 24/48/60 V AC/DC

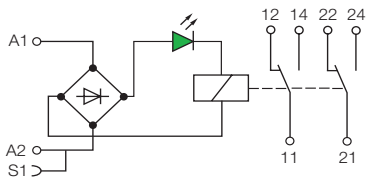

2CDC 292 044 F0013

RB/RBR 122 A - 115/230 V AC/DC

Interface relays R600 range

Technical data

Technical data

		RB... 111A high level				
Input circuit						
Rated control supply voltage U_s		24 V AC/DC	48 V AC/DC	60 V AC/DC	115 V AC/DC	230 V AC/DC
Rated control supply voltage U_s tolerance	DC	-15 %, +20 %				-15 %, +10 %
	AC	-/+ 10 %				
Rated frequency		50/60 Hz				
Typical power consumption		0.24 W	0.34 W	0.54 W	0.46 W	0.8 W
Typical current		10 mA	7 mA	9 mA	4 mA	3.5 mA
Drop-out voltage		4.5 V	8 V	8 V	17 V	27 V
Indication of operational states	green LED	┌: control supply voltage applied				
Output circuit						
Kind of output	13-14	relay, 1 n/o contact				
Rated operational voltage U_e (IEC/EN 60947-1)		250 V AC				
Minimum switching voltage		12 V				
Maximum switching voltage		250 V AC				
Minimum switching current		10 mA				
Rated free air thermal current I_{th}		6 A				
Rated operational current (IEC/EN 60947-5-1)	AC-12 (resistive) 230 V	6 A				
	AC-15 (inductive) 230 V	1.5 A				
	AC-15 (inductive) 120 V	3 A				
	DC-12 (resistive) 24 V	6 A				
	DC-13 (inductive) 24 V	1 A				
	DC-13 (inductive) 120 V	0.2 A				
	DC-13 (inductive) 230 V	0.1 A				
AC rating (UL 508; NEMA ICS-5)	Utilization category (pilot duty)	B300				
DC rating (UL 508; NEMA ICS-5)	Utilization category (pilot duty)	R300				
Minimum switching power		0.6 W / 0.6 VA				
Mechanical lifetime		1 x 10 ⁷ switching cycles				
Electrical lifetime	at AC-15	1 x 10 ⁵ switching cycles				
Response time		5 ms	5 ms	5 ms	6 ms	7 ms
Release time		8 ms	8 ms	8 ms	15 ms	15 ms
Dimensions and weight		RB 111 A			RBR 111 A	
Weight	net weight	0.02 kg (0.044 lb)				
Dimension	product dimension	6 x 70 x 75 mm (0.236 x 2.76 x 2.95 in)			6 x 75 x 75 mm (0.236 x 2.95 x 2.95 in)	

Interface relays R600 range

Technical data

Technical data

		RB... 111AR high level	RB... 101AR high level
Input circuit			
Rated control supply voltage U_s		24 V AC/DC	
Rated control supply voltage U_s tolerance	DC	-15 %, +20 %	
	AC	-/+ 10 %	
Rated frequency		50/60 Hz	
Typical power consumption		0.24 W	
Typical current		10 mA	
Drop-out voltage		4.5 V	
Indication of operational states	green LED	 : control supply voltage applied	
Output circuit			
Kind of output	11-12	-	relay, 1 n/c contact
	13-14	relay, 1 n/o contact	-
Rated operational voltage U_o (IEC/EN 60947-1)		250 V AC	
Minimum switching voltage		12 V	
Maximum switching voltage		250 V AC	
Minimum switching current		10 mA	
Rated free air thermal current I_{th}		6 A	
Rated operational current (IEC/EN 60947-5-1)	AC-12 (resistive) 230 V	6 A	
	AC-15 (inductive) 230 V	1.5 A	
	AC-15 (inductive) 120 V	3 A	
	DC-12 (resistive) 24 V	6 A	
	DC-13 (inductive) 24 V	1 A	
	DC-13 (inductive) 120 V	0.2 A	
	DC-13 (inductive) 230 V	0.1 A	
AC rating (UL 508; NEMA ICS-5)	Utilization category (pilot duty)	B300	
DC rating (UL 508; NEMA ICS-5)	Utilization category (pilot duty)	R300	
Minimum switching power		0.6 W / 0.6 VA	
Mechanical lifetime		1 x 10 ⁷ switching cycles	
Electrical lifetime	at AC-15	1 x 10 ⁵ switching cycles	
Response time		5 ms	
Release time		8 ms	
Dimensions and weight		RB 111AR / RB 101AR high level	RBR 111A / RBR 111AR high level
Weight	net weight	0.03 kg (0.066 lb)	
Dimension	product dimension	12 x 70 x 75 mm (0.472 x 2.76 x 2.95 in)	12 x 75 x 75 mm (0.472 x 2.95 x 2.95 in)

Interface relays R600 range

Technical data

Technical data

		RB... 121 / RB... 121A high level						
Input circuit								
Rated control supply voltage U_s		5 V DC	12 V DC	24 V AC/DC	48 V AC/DC	60 V AC/DC	115 V AC/DC	230 V AC/DC
Rated control supply voltage U_s tolerance	DC	-15 %, +20 %						-15 %, +10 %
	AC	-			-/+ 10 %			
Rated frequency		-			50/60 Hz			
Typical power consumption		0.2 W	0.2 W	0.24 W	0.33 W	0.54 W	0.46 W	0.8 W
Typical current		40 mA	16 mA	10 mA	7 mA	9 mA	4 mA	3.5 mA
Drop-out voltage		1.2 V	2.2 V	4.5 V	8 V	8 V	17 V	27 V
Indication of operational states	green LED	┌: control supply voltage applied						
Output circuit								
Kind of output	11-12/14	relay, 1 c/o (SPDT) contact						
Rated operational voltage U_e (IEC/EN 60947-1)		250 V AC						
Minimum switching voltage		12 V						
Maximum switching voltage		250 V AC						
Minimum switching current		10 mA						
Rated free air thermal current I_{th}		6 A						
Rated operational current	AC-12 (resistive) 230 V	6 A						
	AC-15 (inductive) 230 V	1.5 A						
(IEC/EN 60947-5-1)	AC-15 (inductive) 120 V	3 A						
	DC-12 (resistive) 24 V	6 A						
	DC-13 (inductive) 24 V	1 A						
	DC-13 (inductive) 120 V	0.2 A						
	DC-13 (inductive) 230 V	0.1 A						
AC rating (UL 508; NEMA ICS-5)	Utilization category (pilot duty)	B300						
DC rating (UL 508; NEMA ICS-5)	Utilization category (pilot duty)	R300						
Minimum switching power		0.6 W / 0.6 VA						
Mechanical lifetime		1 x 10 ⁷ switching cycles						
Electrical lifetime	at AC-15	1 x 10 ⁶ switching cycles						
Response time		5 ms	5 ms	5 ms	5 ms	5 ms	6 ms	7 ms
Release time		8 ms	8 ms	8 ms	8 ms	8 ms	15 ms	16 ms
Dimensions and weight		RB 121 / RB 121A high level			RBR 121 / RBR 121 A high level			
Weight	net weight	0.02 kg (0.044 lb)						
Dimension	product dimension	6 x 70 x 75 mm (0.236 x 2.76 x 2.95 in)			6 x 75 x 75 mm (0.236 x 2.95 x 2.95 in)			

Interface relays R600 range

Technical data

Technical data

		RB... 121 / RB... 121A low level						
Input circuit								
Rated control supply voltage U _s		5 V DC	12 V DC	24 V AC/DC	48 V AC/DC	60 V AC/DC	115 V AC/DC	230 V AC/DC
Rated control supply voltage U _s tolerance	DC	-15 %, +20 %						-15 %, +10 %
	AC	-						-/+ 10 %
Rated frequency		-						50/60 Hz
Typical power consumption		0.2 W	0.2 W	0.24 W	0.33 W	0.54 W	0.46 W	0.8 W
Typical current		40 mA	16 mA	10 mA	7 mA	9 mA	4 mA	3.5 mA
Drop-out voltage		1.2 V	2.2 V	4.5 V	8 V	8 V	17 V	27 V
Indication of operational states	green LED	┌: control supply voltage applied						
Output circuit								
Kind of output	11-12/14	relay, 1 c/o (SPDT) contact						
Rated operational voltage U _e (IEC/EN 60947-1)		250 V AC						
Minimum switching voltage		5 V						
Maximum switching voltage		250 V AC						
Minimum switching current		1 mA						
Rated free air thermal current I _{th}		6 A						
Rated operational current (IEC/EN 60947-5-1)	AC-12 (resistive) 230 V	6 A						
	AC-15 (inductive) 230 V	1.5 A						
	AC-15 (inductive) 120 V	3 A						
	DC-12 (resistive) 24 V	6 A						
	DC-13 (inductive) 24 V	1 A						
	DC-13 (inductive) 120 V	0.2 A						
	DC-13 (inductive) 230 V	0.1 A						
AC rating (UL 508; NEMA ICS-5)	Utilization category (pilot duty)	B300						
DC rating (UL 508; NEMA ICS-5)	Utilization category (pilot duty)	R300						
Minimum switching power		0.05 W / 0.05 VA						
Mechanical lifetime		1 x 10 ⁷ switching cycles						
Electrical lifetime	at AC-15	1 x 10 ⁵ switching cycles						
Response time		5 ms	5 ms	5 ms	5 ms	5 ms	6 ms	7 ms
Release time		8 ms	8 ms	8 ms	8 ms	8 ms	15 ms	16 ms
Dimensions and weight		RB 121 / RB 121A low level			RBR 121 / RBR 121 A low level			
Weight	net weight	0.02 kg (0.044 lb)						
Dimension	product dimension	6 x 70 x 75 mm (0.236 x 2.76 x 2.95 in)			6 x 75 x 75 mm (0.236 x 2.95 x 2.95 in)			

5

Interface relays R600 range

Technical data

Technical data

		RB... 121AR			
Input circuit					
Rated control supply voltage U_s		115 V AC/DC	230 V AC/DC	24 V AC/DC	
Rated control supply voltage U_s tolerance	DC	-20%, +15%	-10%, +15%	-20%, +15%	
	AC	-/+ 10 %			
Rated frequency		50/60 Hz			
Typical power consumption		2 W	2.8 W	0.24 W	
Typical current		18 mA	12 mA	10 mA	
Drop-out voltage		17 V	27 V	4.5 V	
Indication of operational states	green LED	┌───┐: control supply voltage applied			
Output circuit					
Kind of output	11-12/14	relay, 1 c/o (SPDT) contact			
Rated operational voltage U_o (IEC/EN 60947-1)		250 V AC			
Minimum switching voltage		12 V			
Maximum switching voltage		250 V AC			
Minimum switching current		10 mA			
Rated free air thermal current I_{th}		6 A			
Rated operational current (IEC/EN 60947-5-1)	AC-12 (resistive) 230 V	6 A			
	AC-15 (inductive) 230 V	1.5 A			
	AC-15 (inductive) 120 V	3 A			
	DC-12 (resistive) 24 V	6 A			
	DC-13 (inductive) 24 V	1 A			
	DC-13 (inductive) 120 V	0.2 A			
	DC-13 (inductive) 230 V	0.1 A			
AC rating (UL 508; NEMA ICS-5)	Utilization category (pilot duty)	B300			
DC rating (UL 508; NEMA ICS-5)	Utilization category (pilot duty)	R300			
Minimum switching power		0.6 W / 0.6 VA			
Mechanical lifetime		1 x 10 ⁷ switching cycles			
Electrical lifetime	at AC-15	1 x 10 ⁶ switching cycles			
Response time		6 ms	7 ms	5 ms	
Release time		15 ms	16 ms	8 ms	
Dimensions and weight		RB 121AR		RB 121AR	
Weight	net weight	0.03 kg (0.066 lb)			
Dimension	product dimension	12 x 70 x 75 mm (0.472 x 2.76 x 2.95 in)		12 x 75 x 75 mm (0.472 x 2.95 x 2.95 in)	

5

Technical data

		RB... 122A low level					
Input circuit							
Rated control supply voltage U_s		24 V AC/DC	48 V AC/DC	60 V AC/DC	115 V AC/DC	230 V AC/DC	
Rated control supply voltage U_s tolerance	DC	-15 %, +20 %				-15 %, +10 %	
	AC	-/+ 10 %					
Rated frequency		50/60 Hz					
Typical power consumption		0.48 W	0.62 W	0.96 W	0.58 W	1.15 W	
Typical current		20 mA	13 mA	16 mA	5 mA	5 mA	
Drop-out voltage		5.4 V	8.8 V	8.8 V V	20 V	10 V	
Indication of operational states	green LED	┌───┐: control supply voltage applied					
Output circuit							
Kind of output	11-12/14	relay, 1st c/o (SPDT) contact					
	21-22/24	relay, 2nd c/o (SPDT) contact					
Rated operational voltage U_o (IEC/EN 60947-1)		250 V AC					
Minimum switching voltage		5 V					
Maximum switching voltage		250 V DC - 250 V AC					
Minimum switching current		1 mA					
Rated free air thermal current I_{th}		8 A			5 A		
Rated operational current (IEC/EN 60947-5-1)	AC-12 (resistive) 230 V	8 A			5 A		
	DC-12 (resistive) 24 V	8 A			5 A		
Minimum switching power		5 mW / 5 mVA					
Mechanical lifetime		2 x 10 ⁷ switching cycles					
Electrical lifetime	at AC-15	1 x 10 ⁶ switching cycles					
Response time		6 ms	10 ms	10 ms	6 ms	6 ms	
Release time		10 ms	14 ms	14 ms	15 ms	15 ms	
Dimensions and weight		RB 122A low level			RBR 122A low level		
Weight	net weight	0.03 kg (0.066 lb)					
Dimension	product dimension	12 x 70 x 75 mm (0.472 x 2.76 x 2.95 in)			12 x 75 x 75 mm (0.472 x 2.95 x 2.95 in)		

Interface relays R600 range

General technical data

Technical data

		RB	RBR
General data			
Material of housing		UL 94 V0	
Mounting		DIN Rail	
Degree of protection	housing / terminals	IP20 NEMA1	
Electrical connection		Screw terminal	Spring-type terminal
Wire size	fine-stranded	0.22-2.5 mm ² (24-14 AWG)	
	rigid	0.2-4 mm ² (24-12 AWG)	0.2-2.5 mm ² (24-14 AWG)
Stripping length		9 mm / 0.354 in	
Tightening torque		0.4-0.6 Nm (3.5-5.3 lb.in)	
Environmental data			
Ambient temperature ranges	storage	-40...+80 °C	
	operation	-20...+70 °C	
Isolation data			
Rated insulation voltage U _i (IEC/EN 60950-1, EN 50178)		4000 V RMS	
Rated impulse withstand voltage U _{imp} (EN 50178)	input / output	4000 V RMS (RB122A: 3800 V RMS, RB111AR: 3500 V RMS)	
	shock coil / output	4000 V RMS	
	output / output	1000 V RMS	

5

Interface relays R600 range

Dimensional drawings, Load limit curves

All interface relays of R600 range

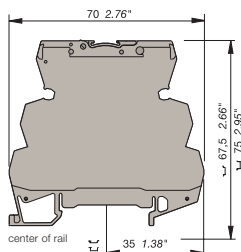

Screw clamp module

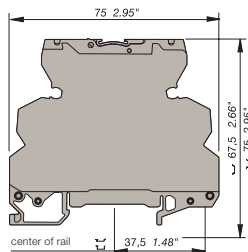

Spring clamp module

Load limit curves

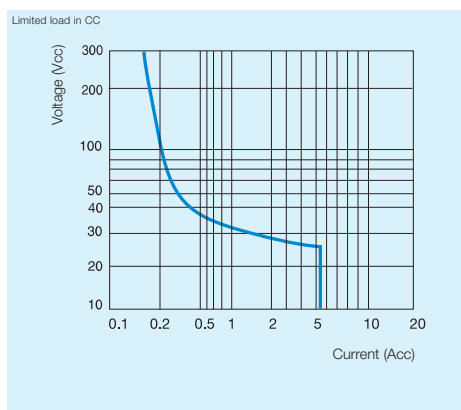

Versions with 1 n/o, 1 n/c or 1 c/o contact

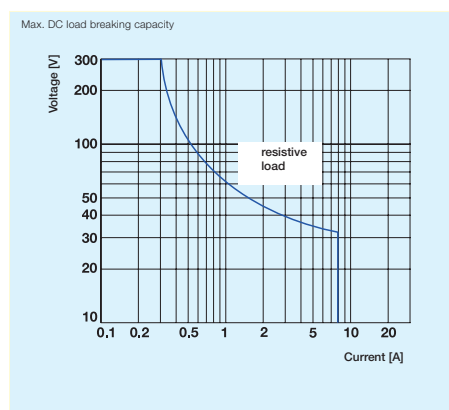

Versions with 2 c/o contacts

	DC-12	AC-12	DC-13	AC-15
24 V	6 A	6 A	1	3 A
110/120 V	0.3 A	6 A	0.2 A	3 A
220/230 V	0.2 A	6 A	0.1 A	3 A

Optocouplers R600 range Selection

Type	Order number
OBIC 0100 5-12VDC	1SNA645047R0000
OBIC 0100 5-12VDC	1SNA645547R0200
OBIC 0100 24VDC	1SNA645021R2600
OBIC 0100 24VDC	1SNA645521R2000
OBIC 0100 48-60VAC/DC	1SNA645049R1200
OBIC 0100 48-60VAC/DC	1SNA645549R1400
OBIC 0100 115-230VAC/DC	1SNA645022R2700
OBIC 0100 115-230VAC/DC	1SNA645522R2100
OBIC 1000-5-12VDC	1SNA645060R1700
OBIC 1000-5-12VDC	1SNA645560R1100
OBIC 1000-24VDC	1SNA645051R0400
OBIC 1500-24VAC/DC	1SNA645025R2200
OBIC 5000-24VDC	1SNA645024R2100
OBIC 1000-24VDC	1SNA645551R0600
OBIC 1500-24VAC/DC	1SNA645525R2400
OBIC 5000-24VDC	1SNA645524R2300
OBIC 1000-48-60VAC/DC	1SNA645053R0600
OBIC 1000-48-60VAC/DC	1SNA645553R0000
OBIC 1000-115VAC/DC	1SNA645054R0700
OBIC 5000-115VAC/DC	1SNA645068R1300
OBIC 1000-115VAC/DC	1SNA645554R0100
OBIC 5000-115VAC/DC	1SNA645558R1500
OBIC 1000-230VAC/DC	1SNA645026R2300
OBIC 5000-230VAC/DC	1SNA645059R1400
OBIC 1000-230VAC/DC	1SNA645526R2500
OBIC 5000-230VAC/DC	1SNA645559R1600
OBOA 1000-24VDC	1SNA645027R2400
OBOA 2000-24VDC	1SNA645029R0600
OBOA 1000-24VDC	1SNA645527R2600
OBOA 2000-24VDC	1SNA645529R0000

Input voltage	1	2	3	4	5	6	7	8	9	10	11	12	13	14	15	16	17	18	19	20	21	22	23	24	25	26	27	28	29	30
5-12 V DC	■	■																												
24 V DC			■	■																										
48-60 V DC					■	■																								
115-230 V DC																														
115 V DC																														
230 V DC																														
24 V AC																														
48-60 V AC																														
115-230 V AC																														
115 V AC																														
230 V AC																														

Output rating	1	2	3	4	5	6	7	8	9	10	11	12	13	14	15	16	17	18	19	20	21	22	23	24	25	26	27	28	29	30
100 mA	■	■	■	■	■	■	■	■																						
2 A																														
5 A																														
1 A																														

Output voltage	1	2	3	4	5	6	7	8	9	10	11	12	13	14	15	16	17	18	19	20	21	22	23	24	25	26	27	28	29	30
58 V DC	■	■	■	■	■	■	■	■	■	■	■	■	■	■	■	■	■	■	■	■	■	■	■	■	■	■	■	■	■	■
230 V AC																														
400 V AC																														

Terminal type	1	2	3	4	5	6	7	8	9	10	11	12	13	14	15	16	17	18	19	20	21	22	23	24	25	26	27	28	29	30
Screw	■		■		■		■		■		■		■		■		■		■		■		■		■		■		■	
Spring		■		■		■		■		■		■		■		■		■		■		■		■		■		■		■

Optocouplers R600 range Selection

OBOA 1000-48-60VAC/DC	1SNA645061R0600																			
OBROA 1000-48-60VAC/DC	1SNA645561R0000																			
OBOA 1000-115VAC/DC	1SNA645062R0700																			
OBROA 1000-115VAC/DC	1SNA645562R0100																			
OBOA 1000-230VAC/DC	1SNA645028R0500																			
OBROA 1000-230VAC/DC	1SNA645528R0700																			

Optocouplers R600 range

Ordering details



2CDC 291 001 F0013

5

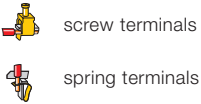

screw terminals
spring terminals

Ordering details - R600 range

R600 Optocoupler	Type	Order code	Price	Pkg qty	Weight (1 pce) kg (lb)
Optocoupler module 100 mA/DC	OBIC 0100-5-12VDC	1SNA645047R0000		10	0.02 (0.44)
	OBIC 0100-24VDC	1SNA645021R2600			
	OBIC 0100-48-60VAC/DC	1SNA645049R1200			
Optocoupler module 100 mA/DC	OBRIC 0100-5-12VDC	1SNA645547R0200		10	0.02 (0.44)
	OBRIC 0100-24VDC	1SNA645521R2000			
	OBRIC 0100-48-60VAC/DC	1SNA645549R1400			
Optocoupler module 2 A/DC	OBOC 1000-5-12VDC	1SNA645050R1700		10	0.02 (0.44)
	OBOC 1000-24VDC	1SNA645051R0400			
	OBOC 1500-24VAC/DC	1SNA645025R2200			
	OBOC 1000-48-60VAC/DC	1SNA645053R0600			
	OBOC 1000-115VAC/DC	1SNA645054R0700			
Optocoupler module 2 A/DC	OBROC 1000-5-12VDC	1SNA645026R2300		10	0.02 (0.44)
	OBROC 1000-24VDC	1SNA645550R1100			
	OBROC 1000-48-60VAC/DC	1SNA645551R0600			
	OBROC 1500-24VAC/DC	1SNA645525R2400			
	OBROC 1000-115VAC/DC	1SNA645553R0000			
Optocoupler module 5 A/DC	OBOC 5000-24VDC	1SNA645024R2100		10	0.02 (0.44)
	OBOC 5000-115VAC/DC	1SNA645058R1300			
	OBOC 5000-230VAC/DC	1SNA645059R1400			
Optocoupler module 5 A/DC	OBROC 5000-24VDC	1SNA645524R2300		10	0.02 (0.44)
	OBROC 5000-115VAC/DC	1SNA645558R1500			
	OBROC 5000-230VAC/DC	1SNA645559R1600			
Optocoupler module 1 A/AC 6 mm spacing	OBOA 1000-24VDC	1SNA645027R2400		10	0.03 (0.066)
	OBOA 1000-48-60VAC/DC	1SNA645061R0600			
	OBOA 1000-115VAC/DC	1SNA645062R0700			
Optocoupler module 2 A/AC 12 mm spacing	OBOA 2000-24VDC	1SNA645028R0500		5	0.03 (0.066)
	OBROA 1000-24VDC	1SNA645029R0600			
	OBROA 1000-48-60VAC/DC	1SNA645527R2600			
Optocoupler module 1 A/AC 6 mm spacing	OBROA 1000-115VAC/DC	1SNA645561R0000		10	0.03 (0.066)
	OBROA 1000-230VAC/DC	1SNA645562R0100			
	OBROA 1000-115VAC/DC	1SNA645528R0700			
Optocoupler module 2 A/AC 12 mm spacing	OBROA 2000-24VDC	1SNA645529R0000		5	0.03 (0.066)

Accessories	Type	Order code	Price	Pkg qty	Weight (1 pce) kg (lb)
End section	BADH V0	1SNA116900R2700		50	
	BADL V0	1SNA399903R0200		50	
	BAM2 V0	1SNA399967R0100		50	
Separator end section	SC 612	1SNA290474R0200		10	
Divisible shunt 10 poles	BJ 612-10	1SNA290488R0100		10	
Divisible shunt 20 poles	BJ 612-20	1SNA206754R0000		10	
Test plug DIA. 2 mm	FC2	1SNA645531R2200		10	
Marking method	RC65 / RC610	see marking			

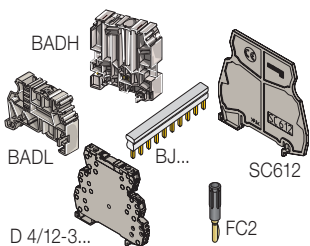

Optocouplers R600 range

Connection diagrams

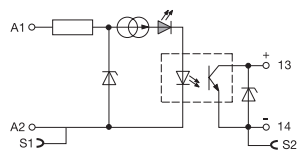

OB...IC 0100 - 5-12 V DC
115-230 V AC/DC

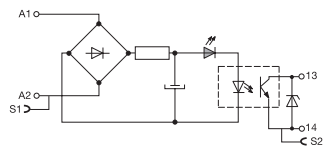

OB...IC 0100
24 V DC
24-48-60 V AC/DC

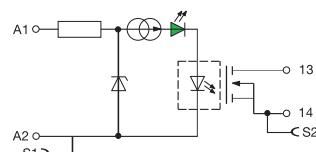

OB...OC 1000 - 5-12 V DC

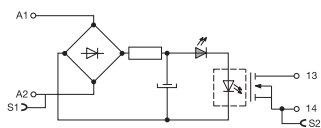

OB...OC 1500 - 24 V AC/DC
OB...OC 1000
24 V DC
48-60-115-230 V AC/DC

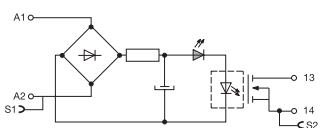

OB...OC 5000
24 V DC
24-48-60-115-230 V AC/DC

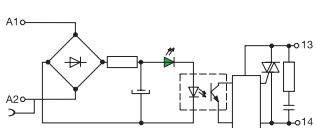

OB...OA 1000
24 V DC
48-60-115-230 V AC/DC
OB...OA 2000 - 24 V DC

Optocouplers R600 range

Technical data

Optocoupler : 5 to 58 V DC output / 100 mA - 6 mm 0.236" spacing

OB...IC 0100

Relay characteristics coil

Input voltage: +20%, -15% on DC ; 10%, -10% on AC	5 V DC - 12 V DC	24 V DC	48 V AC/DC	60 V AC/DC	115 V AC/DC	230 V AC/DC	
Frequency			50 / 60 Hz				
Input current AC/DC	5 mA	9 mA	4 mA	4 mA	5 mA	7 mA / 16 mA	11.5 mA / 25 mA
Pull-in voltage at Is=100%	4 V		15 V		25 V		60 V AC / 70 V DC
Switching time C / O	10 µs / 500 µs						
Operating frequency	1000 Hz						
Permissible leakage current			5 ms / 20 ms		5 ms / 15 ms		

Output

Output voltage	0.9 mA		1 mA		0.9 mA		1.6 mA	
Output current min.	4.5 to 58 V DC							
Output current max.	1 mA							
Output leakage current at U _{max}	100 mA							
Residual voltage at I max and U rated	typical	1 V					max	1.3 V
Frequency on inductive load								
Isolation Input / Output	input / Output	2500 V RMS						
Temperature	storage	-40...+80 °C					operating	-20...+70 °C ¹⁾

Other characteristics

		Screw clamp	Spring clamp
Body material	grey	UL 94 V0	
Wire size	Solid wire	0.2 - 4 mm ² (24-12 AWG)	0.2-2.5 mm ² (24-12 AWG)
	Stranded wire	0.22 - 2.5 mm ² (24-12 AWG)	
Rated wire size		2.5 mm ² (12 AWG)	
Wire stripping length		9 mm (0.354 in)	
Recommended screwdriver		3.5 mm (0.137 in)	
Protection		IP20 NEMA1	
Recommended torque		0.4-0.6 Nm (3.5-5.3 lb.in)	
Approvals		cULus (pending for 12 V DC) , CE (pending), UL, LRS , CE	
Reference standards		CEI 947-7-1 / CEI 947-1 / CEI 1131-2 (in relevant parts) / CEI 60664-1 / CEM : IEC 1000-4-2, 3, 4, 5, 6.	

¹⁾ Over 55°C, blocks have to be mounted on horizontal rail with 10 mm spacing between each block. For vertical rail mounting use temperature is 15°C less decreased.

Dimensional drawings

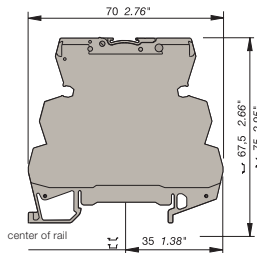

Screw clamp module

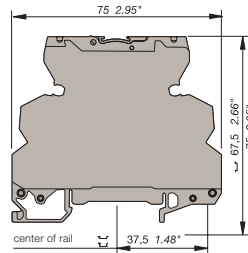

Spring clamp module

Optocouplers R600 range

Technical data

Optocoupler : 5 to 58 V DC output / 2 A - 6 mm 0.236" spacing

	OB...OC 0100		OB..OC 1500	OB...OC 1000					
Relay characteristics coil									
Input voltage: +20%, -15% on DC ; 10%, -10% on AC	5 V DC - 12 V DC		24 V DC	24 V AC/DC	48 V AC/DC	60 V AC/DC	115 V AC/DC	230 V AC/DC	
Frequency	50 / 60 Hz								
Input current	5 mA	9 mA	4 mA	6.3 mA	4 mA	5.1 mA	4.2 mA	4 mA	
Pull-in voltage at Is=100%	4 V		15 V	15 V	27 V		50 V	80 V	
Switching time C / O	15 µs / 250 µs		30 µs / 400 µs	1 ms / 7 ms	5 ms / 20 ms		500 µs / 10 ms	1 ms / 15 ms	
Operating frequency	2000 Hz		1000 Hz	60 Hz	20 Hz				
Permissible leakage current	1 mA		0.8 mA	0.9 mA	1 mA		0.3 mA		
Output									
Output voltage	4.5 to 58 V DC								
Output current min.	1 mA								
Output current max.	2 A								
Output leakage current at U _{max}	< 50 µA								
Residual voltage at I max and U rated	typical	0.1 V							
	max	0.5 V							
Frequency on inductive load									
Isolation Input / Output	input / Output	2500 V RMS							
Temperature	storage	-40...+80 °C							
	operating	-20...+70 °C ¹⁾							
Other characteristics									
		Screw clamp				Spring clamp			
Body material	grey	UL 94 V0							
Wire size	Solid wire	0.2 - 4 mm ² (24-12 AWG)				0.2-2.5 mm ² (24-12 AWG)			
	Stranded wire	0.22 - 2.5 mm ² (24-12 AWG)							
Rated wire size	2.5 mm ² (12 AWG)								
Wire stripping length	9 mm (0.354 in)								
Recommended screwdriver	3.5 mm (0.137 in)								
Protection	IP20 NEMA1								
Recommended torque	0.4-0.6 Nm (3.5-5.3 lb.in)								
Approvals	c us (pending for 12 V DC) , (pending) , , LRS ,								
Reference standards	CEI 947-7-1 / CEI 947-1 / CEI 1131-2 (in relevant parts) / CEI 60664-1 / CEM : IEC 1000-4-2, 3, 4, 5, 6.								

¹⁾ Over 55°C, blocks have to be mounted on horizontal rail with 10 mm spacing between each block. For vertical rail mounting use temperature is 15°C less decreased.

Dimensional drawings

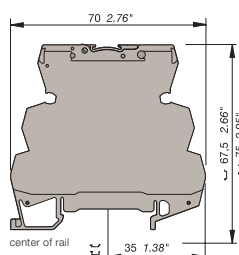

Screw clamp module

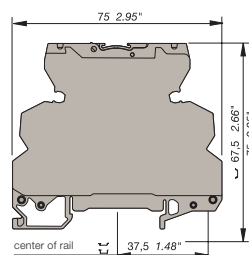

Spring clamp module

Optocouplers R600 range

Technical data

Optocoupler : 5 to 58 V DC output / 5 A - 6 mm 0.236" spacing

OB... OC 5000

Input

Input voltage	24 V DC	115 V AC/DC	230 V AC/DC
Frequency		50 / 60 Hz	50 / 60 Hz
Input current	5.4 mA	4.2 mA	4 mA
Pull-in voltage at $I_s=100\%$	12 V	50 V	80 V
Switching time C / O	30 μ s / 400 μ s	500 μ s / 10 ms	1ms / 15 ms
Operating frequency	1000 Hz	50 Hz	35 Hz
Permissible leakage current	0.8 mA	0.3 mA	0.3 mA



Output

Output voltage	4.5- 58 V DC		
Output current min.	1 mA		
Output current max.	5 A		
Output leakage current at U_{max}	< 50 μ A		
Residual voltage at I_{max} and U_{rated}	typical	0.1 V	
	max	0.5 V	
Frequency on inductive load	See Note 1		
Isolation Input / Output	input / Output	2500 V RMS	

Temperature

Ambient temperature	storage	-40...+80 °C
	operating	See derating curve

Other characteristics

Body material	grey	UL 94 V0
Wire size	Solid wire	0.2 - 4 mm ² (24-12 AWG)
	Stranded wire	0.22 - 2.5 mm ² (24-12 AWG)
Rated wire size		2.5 mm ² (12 AWG)
Wire stripping length		10 mm (0.394 in)
Recommended screwdriver		3.5 mm (0.137 in)
Protection		IP20 NEMA1
Recommended torque		0.4-0.6 Nm (3.5-5.3 lb.in)
Approvals		 (pending), 
Reference standards		CEI 947-7-1 / CEI 947-1 / CEI 1131-2 (in relevant parts) / CEI 60664-1 / CEM : IEC 1000-4-2, 3, 4, 5, 6.

Dimensional drawings

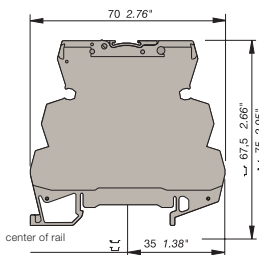

Screw clamp module

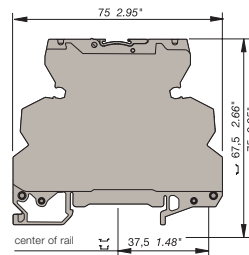

Spring clamp module

Optocouplers R600 range

Technical data

Optocoupler : 24 to 400 V AC output / 1 A or 2 A max. - 6 mm or 12 mm spacing

		OB...OA 1000					OB...OA 2000
Relay characteristics coil							
Input voltage: +20%, -15% on DC ; 10%, -10% on AC	24 V DC	48 V AC/DC	60 V AC/DC	115 V AC/DC	230 V AC/DC	24 V DC	
Frequency		50/60 Hz					
Input current	3.6 mA	4.3 mA	5.5 mA	4.15 mA	4.6 mA	3.6 mA	
Pull-in voltage at Is=100%	14 V	15 V	18 V	60 V	135 V	14 V	
Switching time C / O	150 µs / 1 ms	3 ms / 30 ms		2.2 ms / 18 ms	2.5 ms / 25 ms	150 µs / 1 ms	
Operating frequency	500 Hz	20 Hz		25 Hz	20 Hz	500 Hz	
Permissible leakage current	1 mA						
Output							
Output voltage	24-400 V AC					10-230 V AC	
Frequency	50/60 Hz						
Output current min.	25 mA						
Output current max.	1 A					2 A	
Output leakage current at U _{rated}	< 0.50 mA						
Residual voltage at I max and U rated	typical	1 V					
	max	1.6 V					
Frequency on inductive load							
Isolation Input / Output	input / Output	2500 V RMS					
	storage	-40...+80 °C					
Temperature	operating	-20...+70 °C ¹⁾					
		Screw clamp			Spring clamp		
Body material	grey	UL 94 V0					
Wire size	Solid wire	0.2 - 4 mm ² (24-12 AWG)			0.2-2.5 mm ² (24-12 AWG)		
	Stranded wire	0.22 - 2.5 mm ² (24-12 AWG)					
Rated wire size	2.5 mm ² (12 AWG)						
Wire stripping length	9 mm (0.354 in)						
Recommended screwdriver	3.5 mm (0.137 in)						
Protection	IP20 NEMA1						
Recommended torque	0.4-0.6 Nm (3.5-5.3 lb.in)						
Approvals	cULus (pending for 12 V DC) , CE (pending), LRS , CE						
Reference standards	CEI 947-7-1 / CEI 947-1 / CEI 1131-2 (in relevant parts) / CEI 60664-1 / CEM : IEC 1000-4-2, 3, 4, 5, 6.						

¹⁾ Over 55°C, blocks have to be mounted on horizontal rail with 10 mm spacing between each block. For vertical rail mounting use temperature is 15°C less decreased.

Dimensional drawings

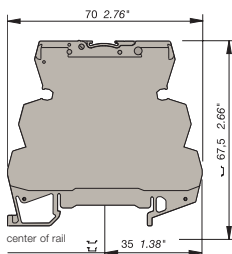

Screw clamp module

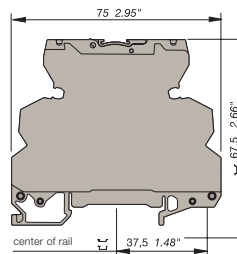

Spring clamp module



Helsinki
tel. +358 9 540 4940
automation@klinkmann.fi

Yekaterinburg
tel. +7 343 287 19 19
yekaterinburg@klinkmann.spb.ru

Vilnius
tel. +370 5 215 1646
post@klinkmann.lt

St. Petersburg
tel. +7 812 327 3752
klinkmann@klinkmann.spb.ru

Samara
tel. +7 846 273 95 85
samara@klinkmann.spb.ru

Tallinn
tel. +372 668 4500
klinkmann.est@klinkmann.ee

Moscow
tel. +7 495 641 1616
moscow@klinkmann.spb.ru

Kiev
tel. +38 044 495 33 40
klinkmann@klinkmann.kiev.ua

Minsk
tel. +375 17 200 0876
minsk@klinkmann.com

Riga
tel. +371 6738 1617
klinkmann@klinkmann.lv