

# CompactLogix 5370 L2 Controllers

Catalog Numbers 1769-L24ER-QB1B, 1769-L24ER-QBFC1B, 1769-L27ERM-QBFC1B



## Important User Information

Solid-state equipment has operational characteristics differing from those of electromechanical equipment. Safety Guidelines for the Application, Installation and Maintenance of Solid State Controls (publication [SGI-1.1](#) available from your local Rockwell Automation sales office or online at <http://www.rockwellautomation.com/literature/>) describes some important differences between solid-state equipment and hard-wired electromechanical devices. Because of this difference, and also because of the wide variety of uses for solid-state equipment, all persons responsible for applying this equipment must satisfy themselves that each intended application of this equipment is acceptable.

In no event will Rockwell Automation, Inc. be responsible or liable for indirect or consequential damages resulting from the use or application of this equipment.

The examples and diagrams in this manual are included solely for illustrative purposes. Because of the many variables and requirements associated with any particular installation, Rockwell Automation, Inc. cannot assume responsibility or liability for actual use based on the examples and diagrams.

No patent liability is assumed by Rockwell Automation, Inc. with respect to use of information, circuits, equipment, or software described in this manual.

Reproduction of the contents of this manual, in whole or in part, without written permission of Rockwell Automation, Inc., is prohibited.

Throughout this manual, when necessary, we use notes to make you aware of safety considerations.



**WARNING:** Identifies information about practices or circumstances that can cause an explosion in a hazardous environment, which may lead to personal injury or death, property damage, or economic loss.



**ATTENTION:** Identifies information about practices or circumstances that can lead to personal injury or death, property damage, or economic loss. Attentions help you identify a hazard, avoid a hazard, and recognize the consequence.



**SHOCK HAZARD:** Labels may be on or inside the equipment, for example, a drive or motor, to alert people that dangerous voltage may be present.



**BURN HAZARD:** Labels may be on or inside the equipment, for example, a drive or motor, to alert people that surfaces may reach dangerous temperatures.

---

### IMPORTANT

Identifies information that is critical for successful application and understanding of the product.

---

Allen-Bradley, Compact I/O, CompactLogix, ControlFLASH, FactoryTalk, FLEX, Integrated Architecture, Kinetix, KwikLink, Logix5000, PanelView, POINT I/O, PowerFlex, Rockwell Software, Rockwell Automation, RSLinx, RSLogix, RSNetWorx, Stratix 6000, Studio 5000, and TechConnect are trademarks of Rockwell Automation, Inc.

Trademarks not belonging to Rockwell Automation are property of their respective companies.

Follow the path that matches your hardware and network configuration.

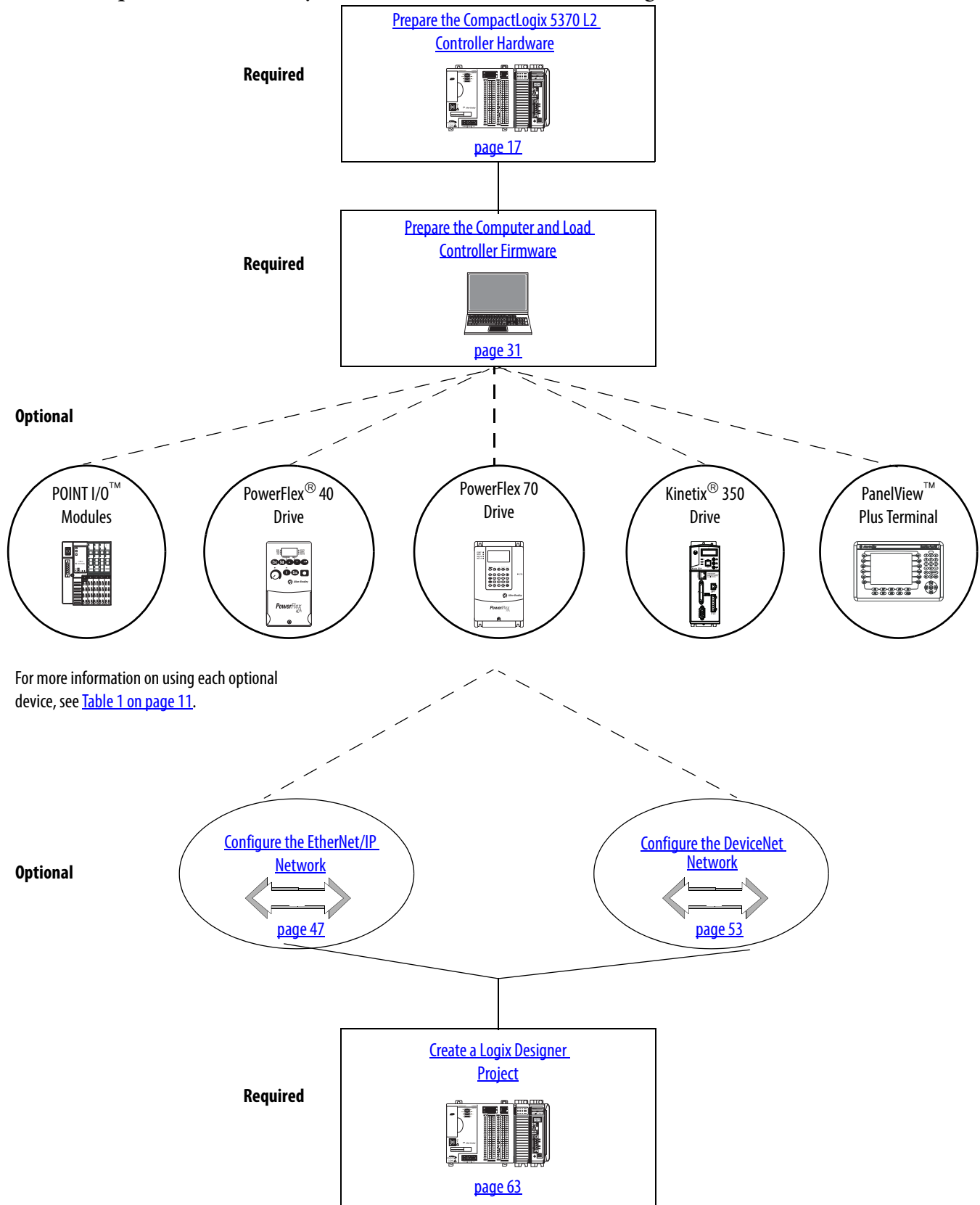

For more information on using each optional device, see [Table 1 on page 11](#).

## How Hardware Is Connected

This quick start, in use with the additional quick starts listed in [Table 1 on page 11](#), describes possible control systems shown in [Figure 1](#) and [Figure 2](#).

**Figure 1 - CompactLogix 5370 L2 Controller in a Star Network Topology**

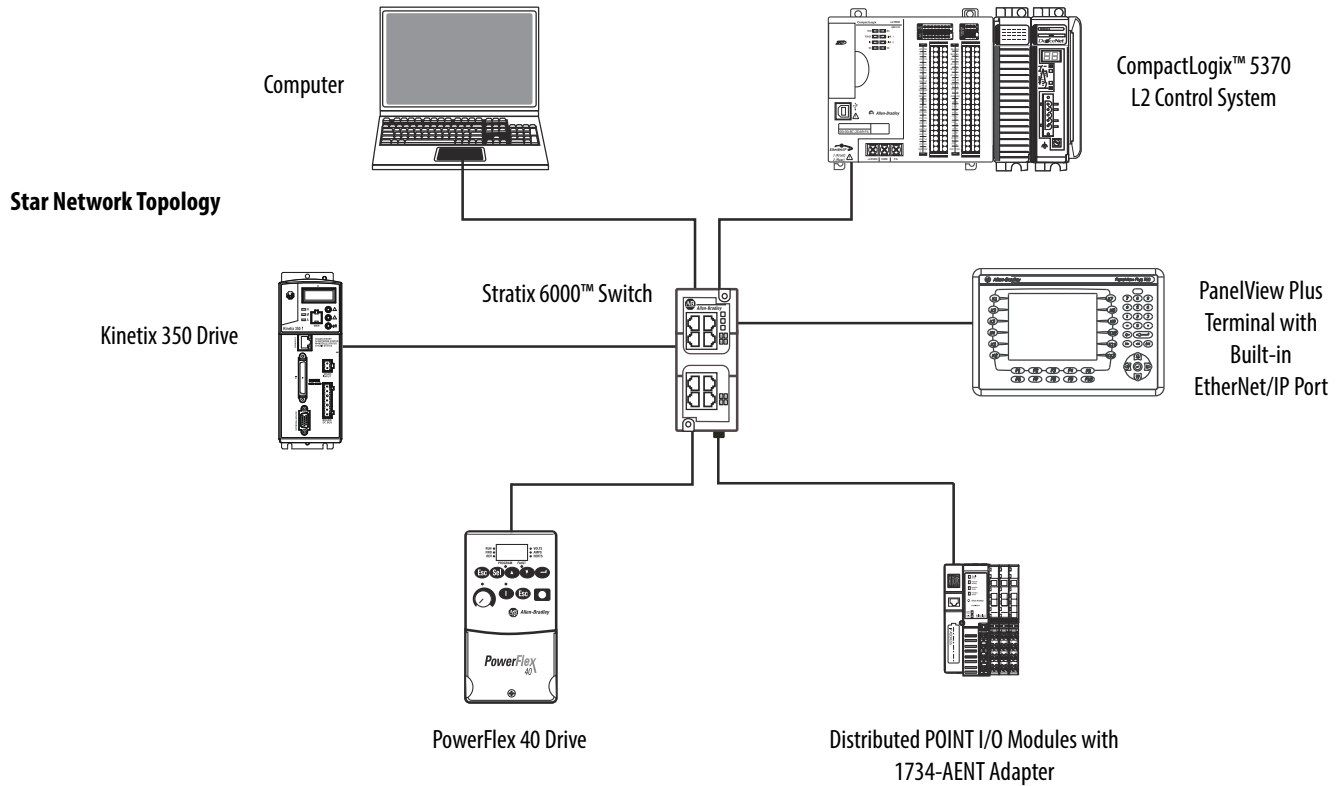

### Application Configuration

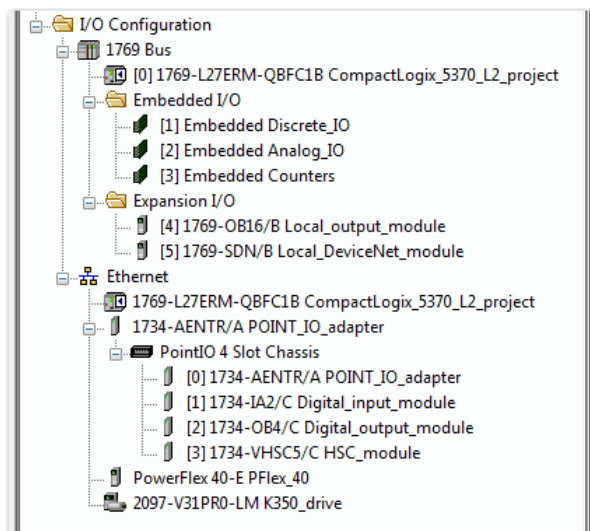
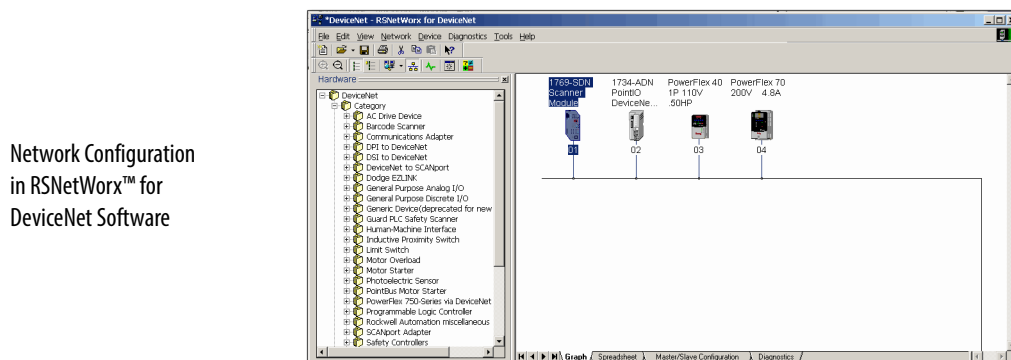
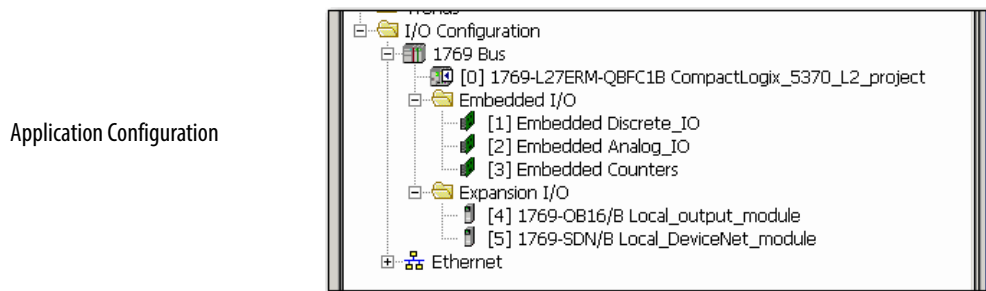
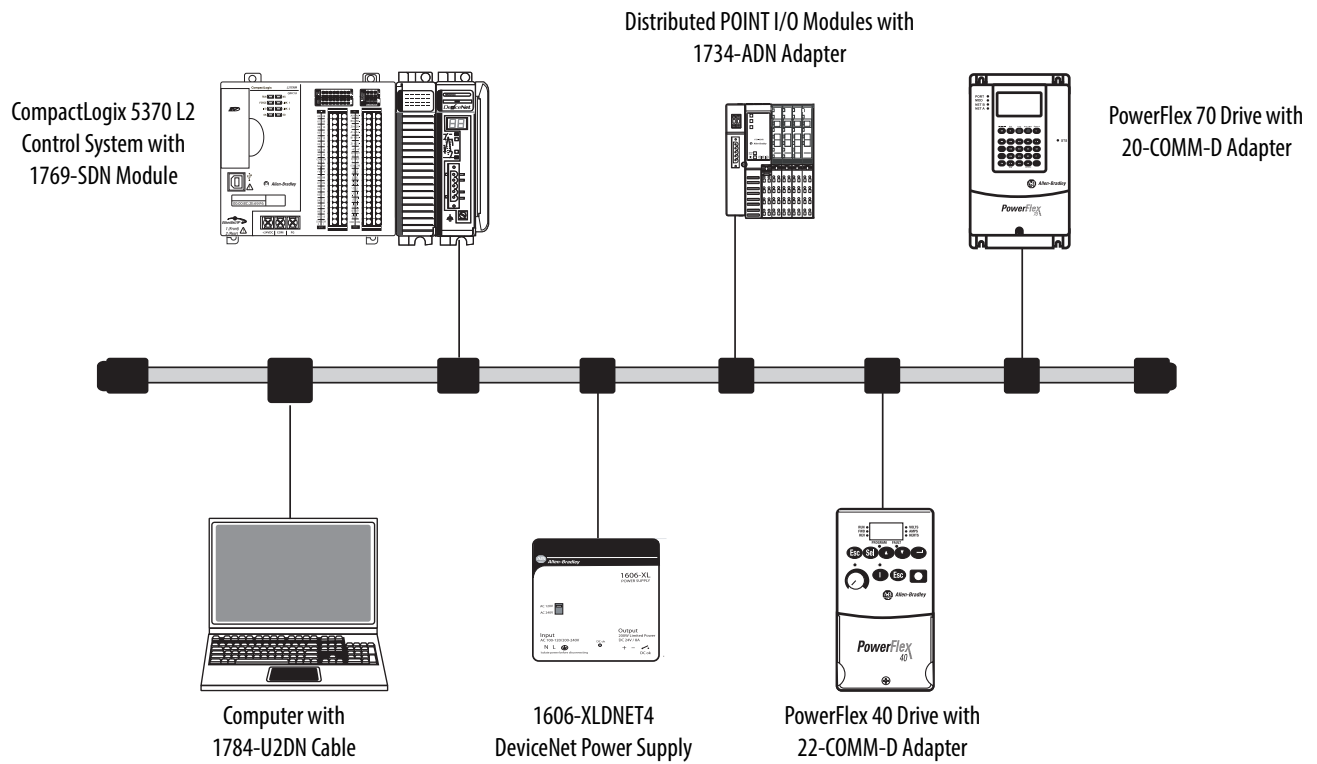



Figure 2 - CompactLogix 5370 L2 Controllers with a DeviceNet Network



## Sample Panel Layout

The sample panel layout shows the orientation of an example CompactLogix 5370 L2 control system using EtherNet/IP networks and DeviceNet networks.

**IMPORTANT** The specific layout of CompactLogix 5370 L2 control systems varies by application. The following graphic is an example panel layout. The graphic shows a PowerFlex 40 drive used on a DeviceNet network. You can also use a PowerFlex 40 drive on an EtherNet/IP network.

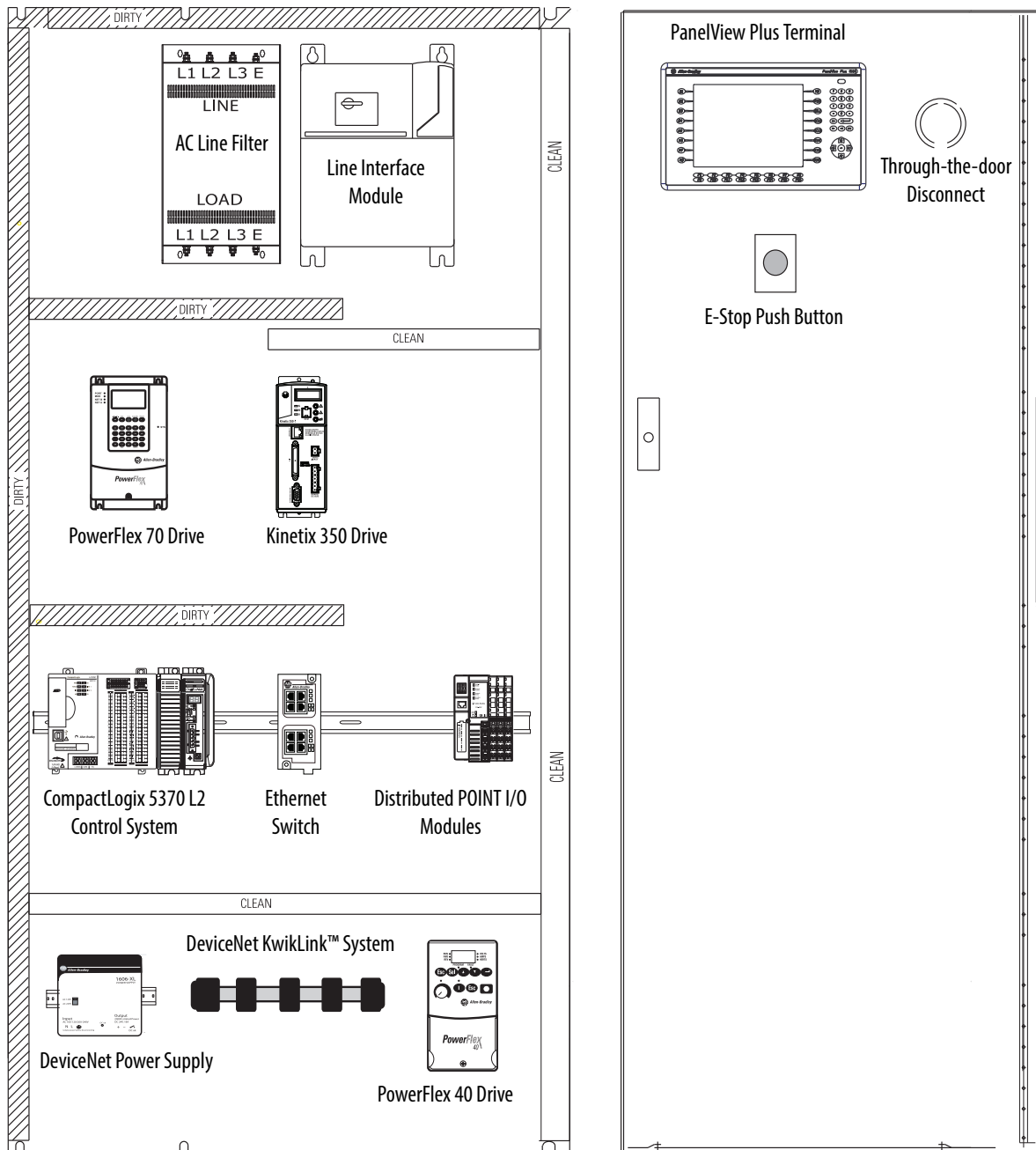

<b>Preface</b>	About the CompactLogix 5370 L2 Controllers . . . . .	10
	Choose to Integrate Optional Devices . . . . .	11
	Studio 5000 Environment . . . . .	13
	Required Software . . . . .	14
	Parts List . . . . .	15
	Additional Resources . . . . .	16
	 <b>Chapter 1</b>	
<b>Prepare the CompactLogix 5370 L2 Controller Hardware</b>	Before You Begin . . . . .	17
	What You Need . . . . .	17
	Follow These Steps . . . . .	18
	Install the Network . . . . .	19
	Install the Secure Digital Card . . . . .	20
	Install the System . . . . .	22
	Connect Power to the Controller . . . . .	25
	Make Network Connections . . . . .	27
	Make a USB Connection . . . . .	27
	Make an EtherNet/IP Network Connection . . . . .	28
	Make a DeviceNet Network Connection . . . . .	29
	 <b>Chapter 2</b>	
<b>Prepare the Computer and Load Controller Firmware</b>	Before You Begin . . . . .	31
	What You Need . . . . .	32
	Follow These Steps . . . . .	33
	Install the Studio 5000 Environment . . . . .	34
	Automatic Installation of ControlFLASH Software . . . . .	36
	Configure an EtherNet/IP Driver in RSLinx Classic Software . . . . .	37
	Set the IP Address for the Computer . . . . .	39
	Load the Controller Firmware . . . . .	42
	Install Additional Software . . . . .	46
	 <b>Chapter 3</b>	
<b>Configure the EtherNet/IP Network</b>	Before You Begin . . . . .	48
	What You Need . . . . .	49
	Assign an IP Address to the Controller over a USB Connection . . . . .	50

<b>Configure the DeviceNet Network</b>	<b>Chapter 4</b>	
	Before You Begin.....	53
	What You Need.....	54
	Follow These Steps.....	55
	Apply Power to the DeviceNet Network.....	56
	Set the 1769-SDN Scanner Module’s Node Address.....	57
	Create a DeviceNet Configuration File.....	59
<b>Create a Logix Designer Project</b>	<b>Chapter 5</b>	
	Before You Begin.....	64
	What You Need.....	64
	Follow These Steps.....	65
	Create a Project.....	66
	Configure the Controller.....	68
	Add the Local Expansion Module.....	70
	Add the 1769-SDN Scanner Module (optional).....	71
	Add Ladder Logic to Use the Local 1769-OB16 Module.....	74
	Download the Project to the Controller and Test the Logic.....	77
<b>Understanding Other Application Options</b>	<b>Appendix A</b>	
	DLR Network Topology.....	80
	Follow These Steps.....	81
	Integrated Motion on the EtherNet/IP Network.....	82
	Follow These Steps.....	82
<b>Index</b>		83

This quick start describes how to use CompactLogix 5370 L2 controllers to install a simple CompactLogix 5370 L2 control system and execute a task with a local expansion 1769 Compact I/O™ output module. The programming examples included are not complex, and offer solutions to verify that devices are functioning and communicating properly.

---

**IMPORTANT** Consider the following points:

- A typical CompactLogix 5370 L2 control system includes more components than listed in this quick start. For example, you can use 1734 POINT I/O modules over an EtherNet/IP network in a CompactLogix 5370 L2 control system. Other quick starts describe how to use additional components with your control system.

For a list of quick starts describing how to use other components in Logix5000™ control systems, see [Choose to Integrate Optional Devices on page 11](#).

- Not all tasks described in this quick start are required to complete the final task, that is, use ladder logic to test a 1769-OB16 output module as described beginning on [page 63](#). For example, you do not need a DeviceNet configuration file to test the module.

We expect that you might attempt to complete additional tasks with your control system by using the publications listed on page 11. When you use those publications, some assumptions are made. For example, if you use a PanelView Plus terminal over an EtherNet/IP network in a CompactLogix 5370 L2 control system, you must have already created a Logix Designer project and assigned an IP address to the controller.

If you complete all of the tasks described in this quick start, you can easily complete the tasks described in the publications listed on page 11.

---

The following topics are described in this quick start:

- Installing hardware for a basic CompactLogix 5370 L2 control system
- Installing software required for the basic CompactLogix 5370 L2 control system
- Installing and configuring an EtherNet/IP network and a DeviceNet network
- Creating a Logix Designer project

## About the CompactLogix 5370 L2 Controllers

These CompactLogix 5370 L2 controllers are available:

- 1769-L24ER-QB1B
- 1769-L24ER-QBFC1B
- 1769-L27ERM-QBFC1B - This controller is used in this quick start.

These features are available on CompactLogix 5370 L2 controllers:

- Secure Digital (SD) card for nonvolatile memory storage
- Network connections:
  - USB (single port)
  - EtherNet/IP network - Device-level ring (DLR), linear, and star topologies are available. For more information on these topologies, see the Ethernet Design Considerations Reference Manual, publication [ENET-RM002](#).
  - DeviceNet network - Via a 1769-SDN scanner module
- I/O module options:
  - 1769 Compact I/O modules as local expansion module
  - Control of distributed I/O modules over a DeviceNet or EtherNet/IP network
- Support for Integrated Motion on the EtherNet/IP network with the 1769-L27ERM-QBFC1B controller only

For more information on using the 1769-L27ERM-QBFC1B controller in an application that includes Integrated Motion on the EtherNet/IP network, see Appendix A on [page 79](#).



This graphic shows a CompactLogix 5370 L2 control system that matches the system you will install after completing steps.

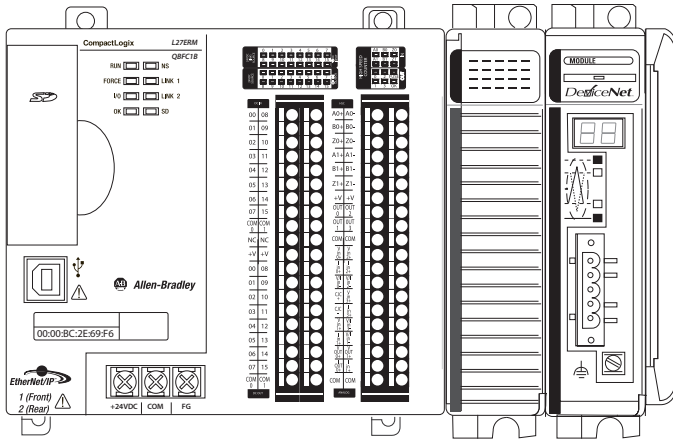

## Choose to Integrate Optional Devices



You can integrate multiple optional devices into a CompactLogix 5370 L2 control system. You can use these devices on DeviceNet or EtherNet/IP networks.

This table describes optional devices you might use in a CompactLogix 5370 L2 control controller system and what resources to use for each.

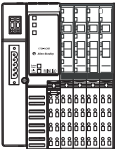
**Table 1 - Devices in Logix5000 Control System**

Device Type	Product Line <sup>(1)</sup>	Additional Resource with More Information
Distributed I/O	POINT I/O 	Logix5000 Control Systems: Connect POINT I/O Modules over a DeviceNet Network Quick Start, publication <a href="#">IASIMP-QS026</a>
		Logix5000 Control Systems: Connect POINT I/O Modules over an EtherNet/IP Network Quick Start, publication <a href="#">IASIMP-QS027</a>

**Table 1 - Devices in Logix5000 Control System**

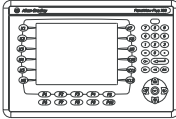
Device Type	Product Line <sup>(1)</sup>	Additional Resource with More Information
Drives	PowerFlex40 	Logix5000 Control Systems: Connect PowerFlex 40 Drives over a DeviceNet Network Quick Start, publication <a href="#">IASIMP-QS028</a> Logix5000 Control Systems: Connect PowerFlex 40 Drives over an EtherNet/IP Network Quick Start, publication <a href="#">IASIMP-QS029</a>
	PowerFlex 70 	Logix5000 Control Systems: Connect PowerFlex 70 Drives over a DeviceNet Network Quick Start, publication <a href="#">IASIMP-QS030</a> Logix5000 Control Systems: Connect PowerFlex 70 Drives over an EtherNet/IP Network Quick Start, publication <a href="#">IASIMP-QS031</a>
	Kinetix 350 	Logix5000 Control Systems: Connect Kinetix 350 Drives over an EtherNet/IP Network Quick Start, publication <a href="#">IASIMP-QS032</a>
HMI terminals	PanelView Plus 	Logix5000 Control Systems: Connect PanelView Plus Terminals over an EtherNet/IP Network Quick Start, publication <a href="#">IASIMP-QS033</a>

(1) You can use other I/O modules, drives, and HMI terminals in Logix5000 control systems. These product lines are used for example purposes.

## Studio 5000 Environment

The Studio 5000™ Engineering and Design Environment combines engineering and design elements into a common environment. The first element in the Studio 5000 environment is the Logix Designer application. The Logix Designer application is the rebranding of RSLogix™ 5000 software and will continue to be the product to program Logix5000™ controllers for discrete, process, batch, motion, safety, and drive-based solutions.



The Studio 5000 environment is the foundation for the future of Rockwell Automation engineering design tools and capabilities. It is the one place for design engineers to develop all the elements of their control system.

## Required Software

Before attempting to complete any of the tasks described in this publication, verify that your computer meets the following operating system and service pack compatibility requirements:

- Microsoft Windows 7 Professional (64-bit) with Service Pack 1
- Microsoft Windows 7 Home Premium (64-bit) with Service Pack 1
- Microsoft Windows 7 Home Premium (32-bit) with Service Pack 1
- Microsoft Windows Server 2008 R2 Standard Edition with Service Pack 1

If your computer does not meet the operating system and service pack compatibility requirements, perform the necessary upgrades before continuing.

[Table 2](#) lists the software used in this quick start. Specific software requirements are listed at the beginning of each chapter.

**Table 2 - Software Used in This Quick Start**

Software	Minimum Version	Required
Studio 5000	21.00.00	Yes
Logix Designer application	21.00.00	Yes
RSLinX <sup>®</sup> Classic	3.51.00	Yes
ControlFLASH <sup>™</sup>	12.00.00 - Automatically installed with Studio 5000 installation	Yes
RSNetWorx for DeviceNet	21.00.00	No <sup>(1)</sup>

(1) Installing RSNetworx for DeviceNet is only required if the automation system includes a DeviceNet network. We recommend that you install RSNetWorx for DeviceNet software to use with devices on a DeviceNet network as described in publications listed in [Table 1](#). For more information, see Chapter 4, [Configure the DeviceNet Network on page 53](#).

## Parts List

[Table 3](#) lists the hardware used in this quick start. The minimum hardware you need depends on the options and examples you choose to complete.

For example, if you do not intend to use a DeviceNet network to complete tasks described in some publications listed in [Table 1](#), you do not need the hardware related to installing a DeviceNet network.

Specific hardware requirements are listed at the beginning of each chapter.

**Table 3 - Parts Used with This Quick Start**

✓	Quantity	Cat. No.	Description
	2 or 3	N/A	DIN rail (steel, not aluminum)
	1	1769-L27ERM-QBFC1B	CompactLogix 5370 L2 controller
	1	1769-OB16	Compact 16-point 24V DC sourcing output module
	1	1769-ECR <sup>(1)</sup>	Compact I/O right end cap/terminator
	1	1783-EMS08T	Stratix 6000 Ethernet managed switch
	1	1606-XLDNET4	Standard switched-mode power supply
	1	1585J-M8PBJM-2	RJ45-to-RJ45 patchcord Ethernet cables
	1	-	USB cable with Type B receptacle
	1	1769-SDN	Compact I/O DeviceNet scanner
	1	1485C-P1E75	KwikLink flat cable, 75 m (246 ft)
	2	1485A-T1E4	KwikLink terminator/resistor
	1	1485P-P1E4-R5	KwikLink sealed micro connector
	1	1485K-P1F5-C	KwikLink QD cordset micro right-angle male
	1	1606-XLDNET8	DeviceNet power supply
	1	1485T-P1E4-B1	KwikLink power tap module

(1) This part ships with the CompactLogix 5370 L2 controller.

## Additional Resources

These documents contain additional information concerning related products from Rockwell Automation.

Resource	Description
CompactLogix 5370 Controllers User Manual, publication <a href="#">1769-UM021</a>	Describes how to design, install, operate, and troubleshoot a CompactLogix 5370 control system.
Logix5000 Control Systems: Connect POINT I/O Modules over a DeviceNet Network Quick Start, publication <a href="#">IASIMP-QS026</a>	Describes basic steps required to include distributed POINT I/O modules over a DeviceNet network in a Logix5000 control system, including hardware, firmware, and software considerations.
Logix5000 Control Systems: Connect POINT I/O Modules over an EtherNet/IP Network Quick Start, publication <a href="#">IASIMP-QS027</a>	Describes basic steps required to include distributed POINT I/O modules over an EtherNet/IP network in a Logix5000 control system, including hardware, firmware, and software considerations.
Logix5000 Control Systems: Connect a PowerFlex 40 Drive over a DeviceNet Network Quick Start, publication <a href="#">IASIMP-QS028</a>	Describes basic steps required to include PowerFlex 40 drives over a DeviceNet network in a Logix5000 control system, including hardware, firmware, and software considerations.
Logix5000 Control Systems: Connect a PowerFlex 40 Drive over an EtherNet/IP Network Quick Start, publication <a href="#">IASIMP-QS029</a>	Describes basic steps required to include PowerFlex 40 drives over an EtherNet/IP network in a Logix5000 control system, including hardware, firmware, and software considerations.
Logix5000 Control Systems: Connect a PowerFlex 70 Drive over a DeviceNet Network Quick Start, publication <a href="#">IASIMP-QS030</a>	Describes basic steps required to include PowerFlex 70 drives over a DeviceNet network in a Logix5000 control system, including hardware, firmware, and software considerations.
Logix5000 Control Systems: Connect a PowerFlex 70 Drive over an EtherNet/IP Network Quick Start, publication <a href="#">IASIMP-QS031</a>	Describes basic steps required to include PowerFlex 70 drives over an EtherNet/IP network in a Logix5000 control system, including hardware, firmware, and software considerations.
Logix5000 Control Systems: Connect a Kinetix 350 Multi-axis Servo Drive System over an EtherNet/IP Network Quick Start, publication <a href="#">IASIMP-QS032</a>	Describes basic steps required to include Kinetix 350 Multi-axis Servo drives over an EtherNet/IP network in a Logix5000 control system, including hardware, firmware, and software considerations.
Logix5000 Control Systems: Connect a PanelView Plus Terminal over an EtherNet/IP Network Quick Start, publication <a href="#">IASIMP-QS033</a>	Describes basic steps required to include PanelView Plus terminals over an EtherNet/IP network in a Logix5000 control system, including hardware, firmware, and software considerations.
ControlFLASH Firmware Upgrade Kit, publication <a href="#">1756-QS105</a>	Provides details regarding the installation of ControlFLASH software and execution of firmware upgrades.
Industrial Automation Wiring and Grounding Guidelines, publication <a href="#">1770-4.1</a>	Provides general guidelines for installing a Rockwell Automation® industrial system.
Product Certifications website, <a href="http://www.ab.com">http://www.ab.com</a>	Provides declarations of conformity, certificates, and other certification details.

You can view or download publications at <http://www.rockwellautomation.com/literature/>. To order paper copies of technical documentation, contact your local Allen-Bradley distributor or Rockwell Automation sales representative.



## Prepare the CompactLogix 5370 L2 Controller Hardware

This chapter describes the hardware required to install your CompactLogix 5370 L2 system.

### Before You Begin

Determine which networks your control system uses. You can use CompactLogix 5370 L2 controllers on an EtherNet/IP network and on a DeviceNet network.

### What You Need

[Table 4](#) lists the hardware components used in this chapter. The parts listed in this table are done so with the assumption that you will install an EtherNet/IP and DeviceNet network.

**Table 4 - Parts Used with This Quick Start**

Quantity	Cat. No.	Description
1 or more	N/A	DIN rail (steel, not aluminum)
1	1769-L27ERM-QBFC1B	CompactLogix 5370 L2 controller
1	1606-XLDNET8	DeviceNet power supply
1	1769-ECR	Compact I/O end cap/terminator
2 or more	1585J-M8PBJM-2	RJ45-to-RJ45 patchcord Ethernet cables
1	-	USB cable with Type B receptacle
1	1783-EMS08T	Stratix 6000 Ethernet managed switch
1	1606-XLDNET4	Standard switched-mode power supply
1	1769-OB16	Compact 16-point 24V DC sourcing output module
1	1769-SDN	Compact I/O DeviceNet scanner
1	1485C-P1E75	KwikLink flat cable, 75 m (246 ft)
2	1485A-T1E4	KwikLink terminator/resistor
2 or more	1485P-P1E4-R5	KwikLink sealed micro connector

**Table 4 - Parts Used with This Quick Start**

Quantity	Cat. No.	Description
1 or more	1485K-P1F5-C	KwikLink QD cordset micro right-angle male
1	1485T-P1E4-B1	KwikLink power tap module

## Follow These Steps

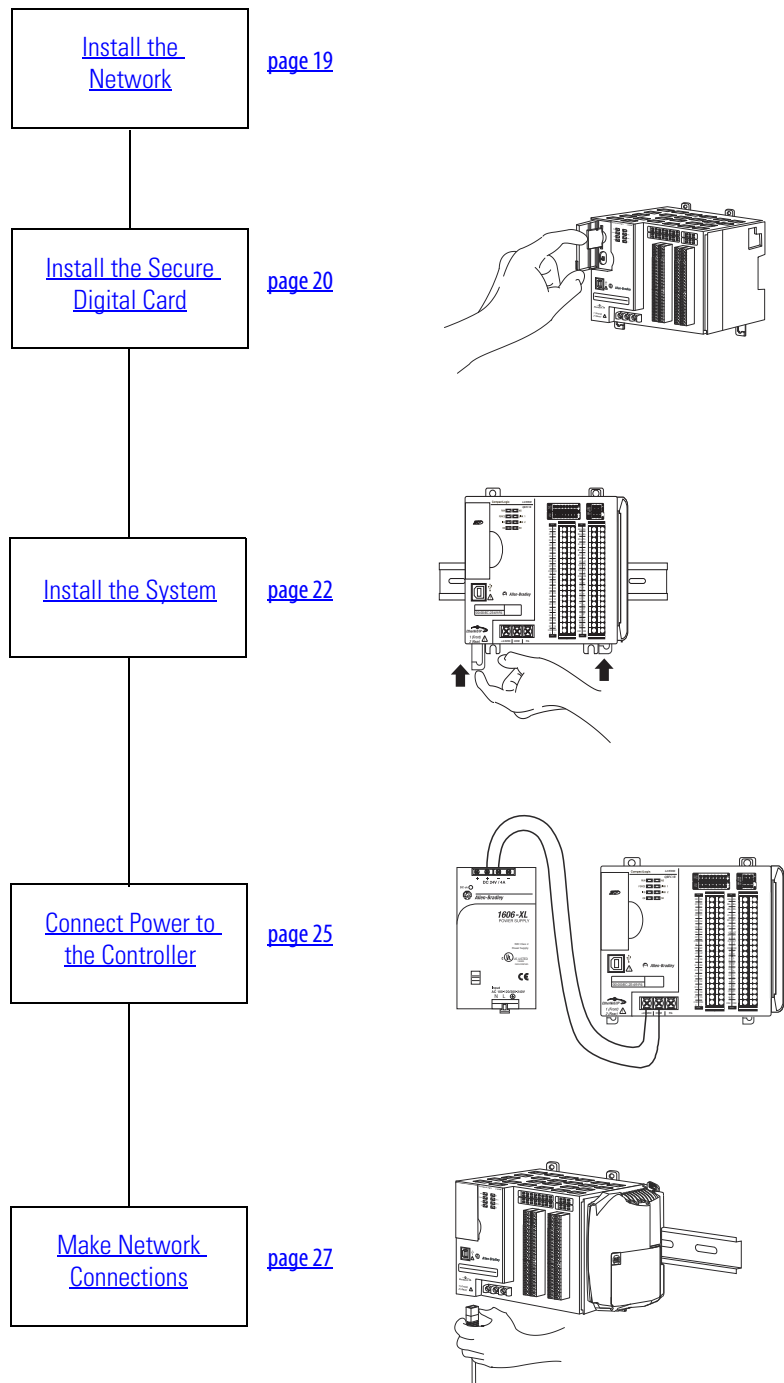

## Install the Network

Before you install your CompactLogix 5370 L2 control hardware, you must install the network on which it will operate, that is, an EtherNet/IP or DeviceNet network.

For more information on installing either of these networks, see the publications listed in the following table.

**Table 5 - Network Publications**

Network	Publication Title	Publication Number
EtherNet/IP	EtherNet/IP Media Planning and Installation Manual	NA - Click <a href="#">here</a> to access the publication
	Stratix 6000 Ethernet Managed Switches Installation Instructions	<a href="#">1783-IN004</a>
	Stratix 6000 Ethernet Managed Switch User Manual	<a href="#">1783-UM001</a>
DeviceNet	DeviceNet Media Design and Installation Guide	<a href="#">DNET-UM072</a>

The publications listed previously describe how to install the communication network and not how to connect your controller to the network. [Make Network Connections on page 27](#) describes how to connect your controller to the networks.

## Install the Secure Digital Card

The Secure Digital (SD) card provides nonvolatile storage for the CompactLogix 5370 L2 controller. You can use the SD card for multiple functions in your application, for example, storing Logix Designer projects on the SD card or loading Logix Designer projects from an SD card.

The following SD cards are available with for use with your CompactLogix 5370 L2 controller:

- 1784-SD1 card - 1 Gb of memory
- 1784-SD2 card - 2 Gb of memory

The CompactLogix 5370 L2 controllers are shipped from the factory with the 1784-SD1 SD card installed.

Complete the following steps to re-install an SD card that has been removed from the controller back into the controller or if installing a new SD card into the controller.



**WARNING:** When you insert or remove the SD card while power is on, an electrical arc can occur. This could cause an explosion in hazardous location installations.

Be sure that power is removed or the area is nonhazardous before proceeding.

---

1. Verify that the SD card is locked or unlocked according to your preference.

Consider these points when deciding whether to lock the card before installation:

- If the card is unlocked, the controller can write data to it or read data from it.
- If the card is locked, the controller can only read data from it.

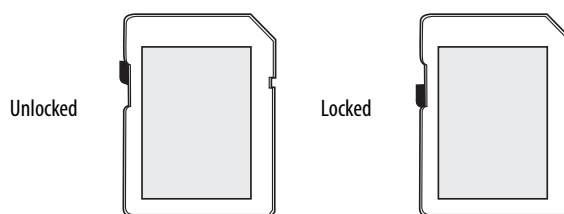

2. Open the door for the SD card.

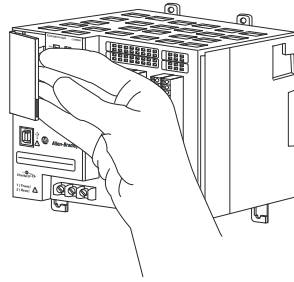

3. Insert the SD card into the SD card slot.

You can install the SD card in one orientation only. You can install the SD card in one orientation only—with the beveled corner at the top. An orientation logo is printed on the card.

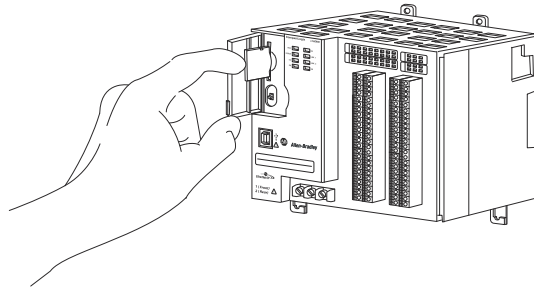

If you feel resistance when inserting the SD card, pull it out and change the orientation.

4. Gently press the card until it clicks into place.
5. Close the SD card door.

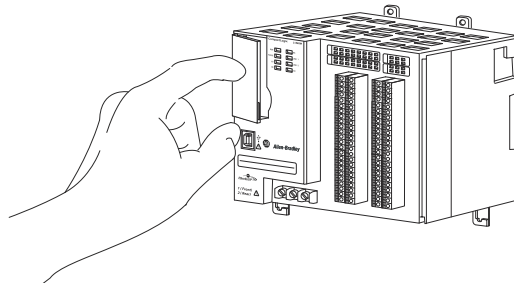

## Install the System

1. Pull the bottom locking tabs out.
2. Hook the top of the controller on the DIN rail.
3. Swing it downward until the controller is flush against the DIN rail and push it down against the DIN rail.

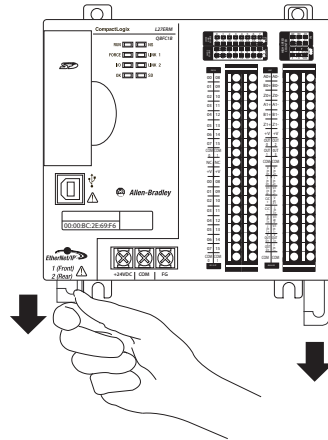

32256-M

4. Push the controller against the DIN rail until the bottom DIN rail locks on the back of the controller click, locking the controller in place.

5. Push the locking tabs in.

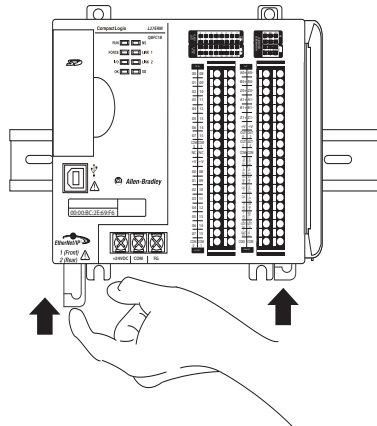

32257-M



6. Install the 1769-OB16 output module.

- a. Make sure the output module's locking tabs are pulled out and the module's bus lever is in the unlocked position, that is, leaning to the right.
- b. Use the upper and lower tongue-and-groove slots to secure the output module and power supply together.
- c. Move the output module back along the tongue-and-groove slots until the bus connectors line up with each other.
- d. Move the output module's bus lever fully to the left until it locks.
- e. Push the locking tabs in.

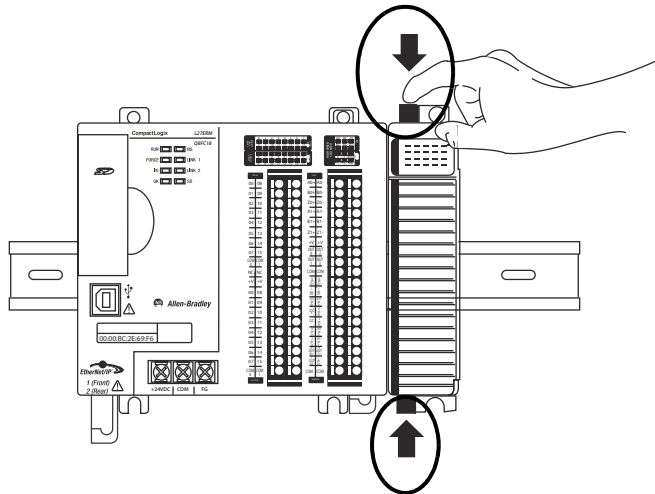
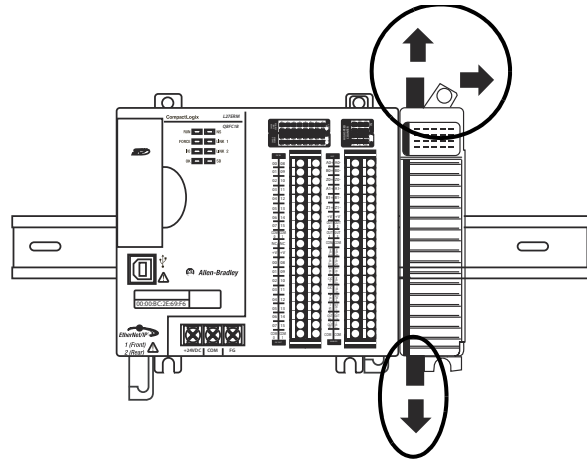

7. Install the 1769-SDN scanner module.

- a. Make sure the scanner module's locking tabs are pulled out.
- b. Make sure the scanner module's bus lever is in the unlocked position, that is, leaning to the right.
- c. Use the upper and lower tongue-and-groove slots to secure the scanner module and power supply together.
- d. Move the scanner module back along the tongue-and-groove slots until the bus connectors line up with each other.
- e. Move the scanner module's bus lever fully to the left until it locks.
- f. Push the locking tabs in.

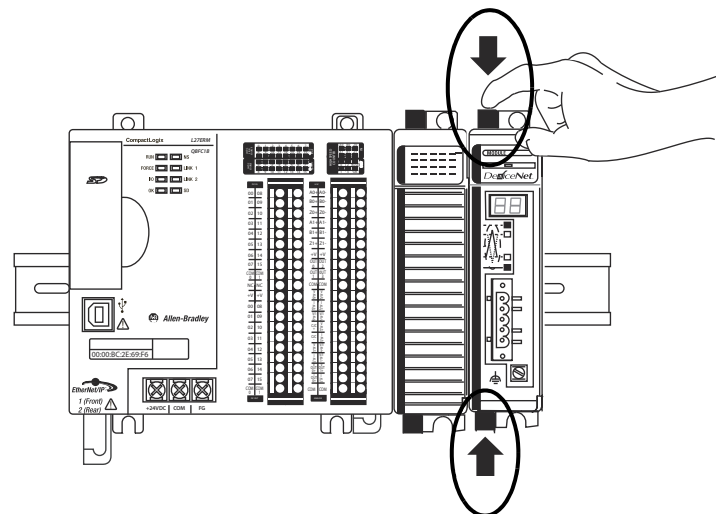
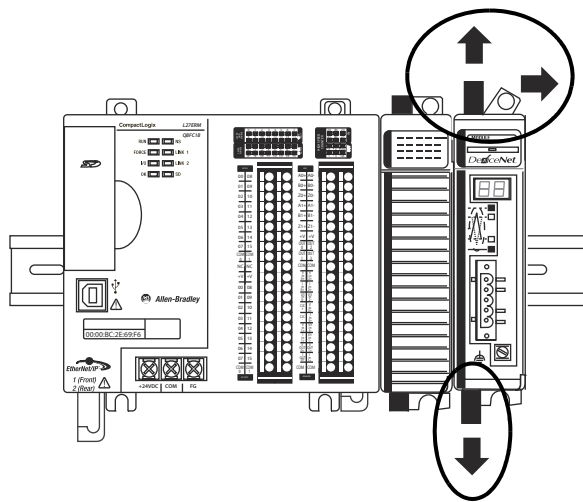

8. Install the 1769-ECR end cap terminator.
  - a. Move the end cap terminator's bus lever to the unlocked position, that is, the right.
  - b. Move the end cap terminator back along the tongue-and-groove slots with the rightmost module in the system until the bus connectors line up with each other.
  - c. Move the end cap terminator's bus lever fully to the left until it locks.

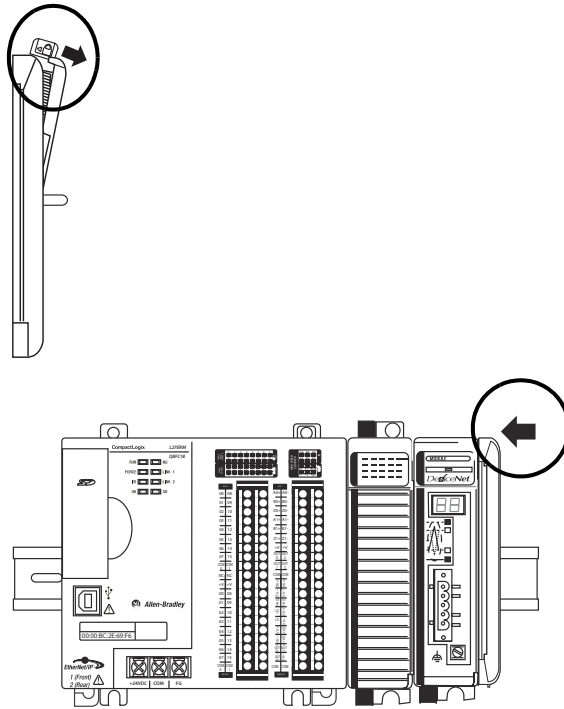

## Connect Power to the Controller

The external 1606-XLDNET4 standard switched-mode power supply converts 115/230V AC power to 24V DC to power the CompactLogix 5370 L2 controller.

1. Verify that the power setting on the external power supply is configured to match the voltage source.
2. Mount the external power supply on the DIN rail.
3. Verify that the wire you use to connect input power to the external power supply is not powered.
4. Remove the clear plastic finger safe cover on the front of the power terminals.

5. Wire input power to the external power supply using the following terminals:

- N (neutral)
- L (line)
-  (ground)

6. Connect a wire from the + terminal on the 1606-XLDNET4 power supply to the +24VDC terminal on the controller.

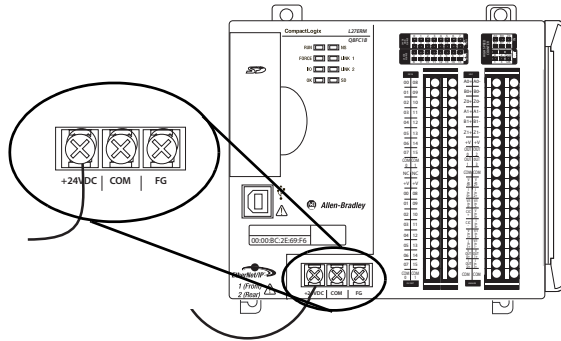

7. Connect the wire from the - terminal on the external power supply to the COM terminal on the controller.

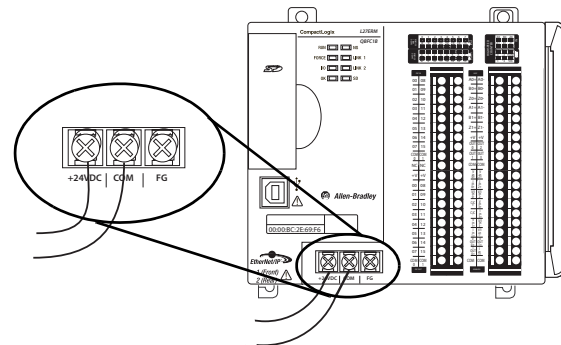

8. Reinstall the clear plastic finger safe cover on the front of the power terminals.

## Make Network Connections

You can make these connections to a CompactLogix 5370 L2 controller:

- [Make a USB Connection](#)
- [Make an EtherNet/IP Network Connection](#)
- [Make a DeviceNet Network Connection](#)

## Make a USB Connection

---

**IMPORTANT** You must use RSLinx Classic software, version 3.51.00 or later, with your CompactLogix 5370 L2 controllers. With this software version, there is no need to install an RSLinx Classic software driver. The driver appears automatically in the software when a USB cable is connected to the controller and the computer.

---

The controller has a USB port that uses a Type B receptacle. The port is USB 2.0-compatible and operates at 12 Mbps.

Use a USB cable to connect your computer to the USB port. With this connection, you can upgrade firmware and download programs to the controller directly from your computer.



**ATTENTION:** The USB port is intended for temporary local programming purposes only and not intended for permanent connection.

The USB cable is not to exceed 3.0 m (9.84 ft) and must not contain hubs.

---



**WARNING:** Do not use the USB port in hazardous locations.

---

1. Plug the USB cable into your CompactLogix 5370 L2 controller.
2. Plug the USB cable into your computer.

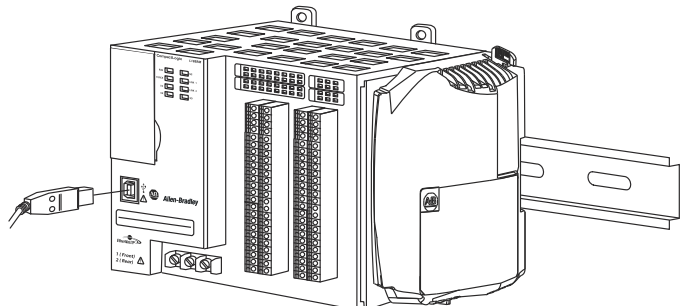

32259-M

## Make an EtherNet/IP Network Connection

---

**IMPORTANT ATTENTION:** This section assumes you installed an EtherNet/IP network as described on [page 19](#) and the network includes a 1783-EMS08T switch.

---

This quick start describes a basic EtherNet/IP network connection. You can use CompactLogix 5370 L2 controllers in multiple EtherNet/IP network topologies as described in the publications listed in [Table 5 on page 19](#).

1. Plug a 1585J-M4TBJM-1, Ethernet cable (straight-through) into a port on the Stratix 6000 switch.
2. Plug the other end of the Ethernet cable into one of the Ethernet ports on the bottom of the controller.



**WARNING:** If you connect or disconnect the communication cable with power applied to this module or any device on the network, an electrical arc can occur. This could cause an explosion in hazardous location installations.

Be sure that power is removed or the area is nonhazardous before proceeding.

---

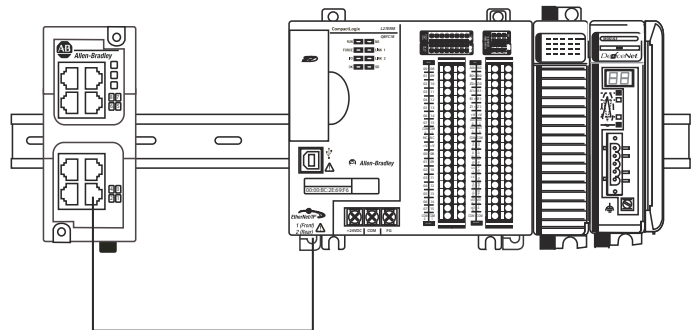

### Set Network IP Address

Once you connect the CompactLogix 5370 L2 controller to an EtherNet/IP network, you must assign the controller a unique IP address. For information about how to set the network IP address for your controller, see Chapter 3, [Configure the EtherNet/IP Network on page 47](#).



## Make a DeviceNet Network Connection

1. Attach and lock the 1606-XLDNET8 DeviceNet power supply to the DIN rail.

The power supply uses a locking tab at the top that you push down to secure it to the DIN rail.

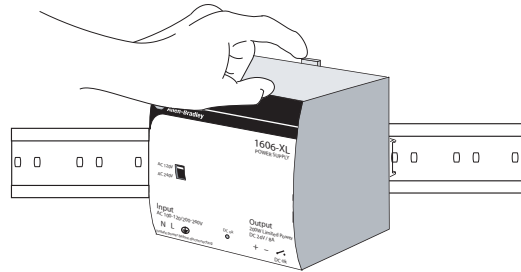

2. Assemble the DeviceNet network cable system using the KwikLink flat cable, terminators, and sealed micro connectors for each device.

For more information on how to assemble the DeviceNet network system, see the instructions included with these devices.

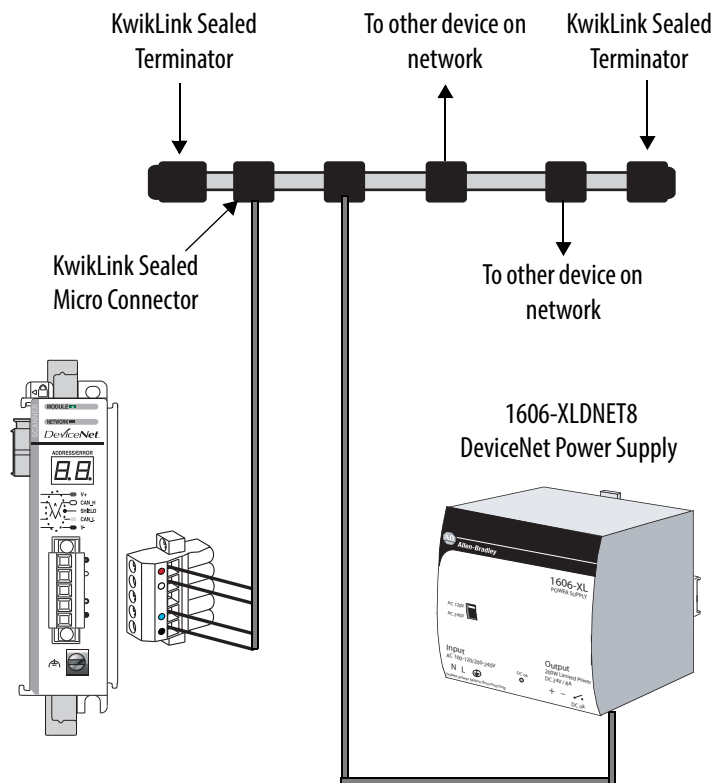

3. Wire a KwikLink QD Micro Cordset to the 1769-SDN connector.

Connect	To
Red	V+
White	CAN High
Bare	Shield
Blue	CAN Low
Black	V-

4. Plug the 1769-SDN connector into the 1769-SDN scanner module.
5. Connect the other end of the KwikLink QD Micro Cordset to a KwikLink sealed micro connector on the network.

## Wire the DeviceNet Network Power Supply



**WARNING:** Verify that all incoming power is turned off before wiring power.

1. Use the information in the following table to connect incoming power to the network power supply.

Connect	To
V AC COM	N (neutral)
120/240V AC	L (line)
Ground	

2. Place the switch in the position that matches your supply voltage.
3. Use the information in the following table to connect the DeviceNet power tap to the power supply.

Connect	To
Red	+
White	N/A
Shield	N/A
Blue	N/A
Black	-



**ATTENTION:** If you have unused DeviceNet wires, make sure they do not come into contact with the other wires.

4. Connect the DeviceNet power tap to the DeviceNet network.
5. Power the 1606- XLDNET4 standard switched-mode power supply connected to the CompactLogix 5370 L2 controller, as described in [Connect Power to the Controller on page 25](#).

## Prepare the Computer and Load Controller Firmware

In this chapter, you install the necessary programming and configuration software, configure network communication on your computer, and load firmware on your controller.

### Before You Begin

Before you begin, complete these tasks:

- Verify that your computer meets the software's system requirements for installation and use of the software listed in [Table 6](#).
- The tasks described in Chapter 1, [Prepare the CompactLogix 5370 L2 Controller Hardware on page 17](#), including the following:
  - Install the EtherNet/IP network and/or the DeviceNet network.
  - Install the controller and the local expansion module.
  - Wire power to the controller.
  - Make network connections.

## What You Need

[Table 6](#) lists the components you use in this chapter.

**Table 6 - What You Need to Prepare the Computer**

Component	Description
Studio 5000 environment	Environment that combines engineering and design elements into a common environment.
Logix Designer application	Software used to create a project the CompactLogix 5370 L2 controller uses in your application.
RSLink Classic software	Communication server that supports multiple software applications simultaneously, establishing communicating between devices on many different Allen-Bradley® industrial networks.
IP address	A number in the form xxx.xxx.xxx.xxx where each xxx is a number from 000 . . . 254.  The IP address uniquely identifies the computer on the EtherNet/IP network.
Subnet Mask	Extension of the IP address that allows a site to use a single network ID for multiple physical networks.  If you change the subnet mask of an already-configured controller, you must cycle power to the controller for the change to take effect.
ControlFLASH software	Software used to upgrade the firmware on certain Allen-Bradley products in a CompactLogix 5370 L2 controller application.  Automatically installed with the Studio 5000 environment installation.
RSNetWorx for DeviceNet software	Configuration software that creates a scanlist of devices that exchange information with the controller over a DeviceNet network.

# Follow These Steps

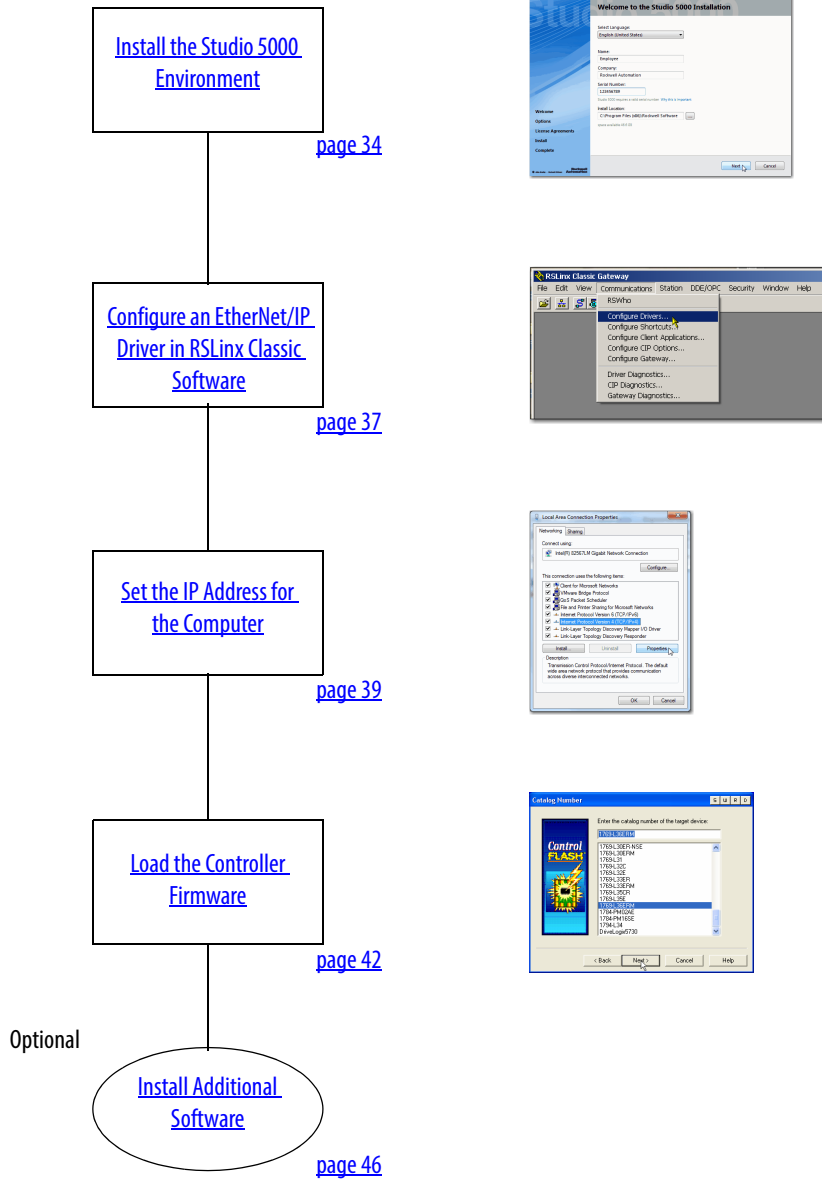

## Install the Studio 5000 Environment

The Studio 5000 environment, version 21.00.00, installation process is configured so that, among other software applications, RSLinx Classic software, version 3.51.00, and RSNetWorx for DeviceNet software, version 21.00.00, are automatically installed.

The automatic installation option is enabled by default. You can change the installation settings and install RSLinx Classic software or RSNetWorx for DeviceNet software separately. We strongly recommend that you use the installation process default settings described in this chapter.

---

**IMPORTANT** The steps described in this section might vary slightly from the steps you complete during your Studio 5000 environment, version 21.00.00, installation.

---

### 1. Start the installation.

You can load the software from a CD or web download.

### 2. Choose a language, fill in the appropriate information, and click Next.

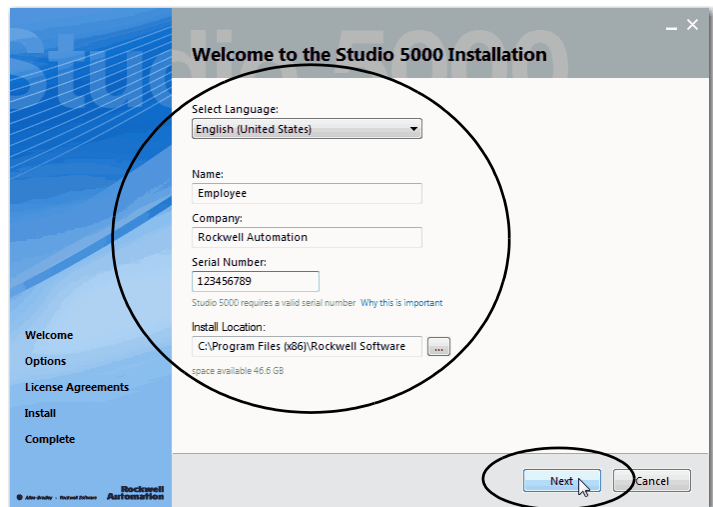

- Use the default selections and click Install.

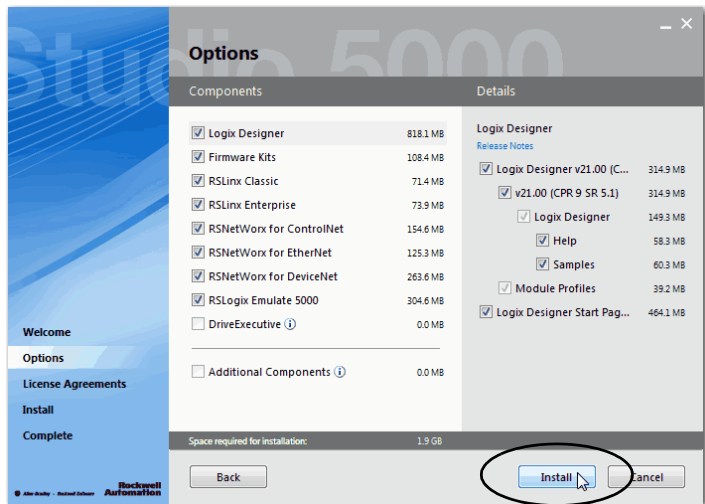

- Read the license agreement carefully.
- Click Accept All.

The installation process begins.

When installation is complete, your computer will have the software necessary required to complete the tasks described in this publication.

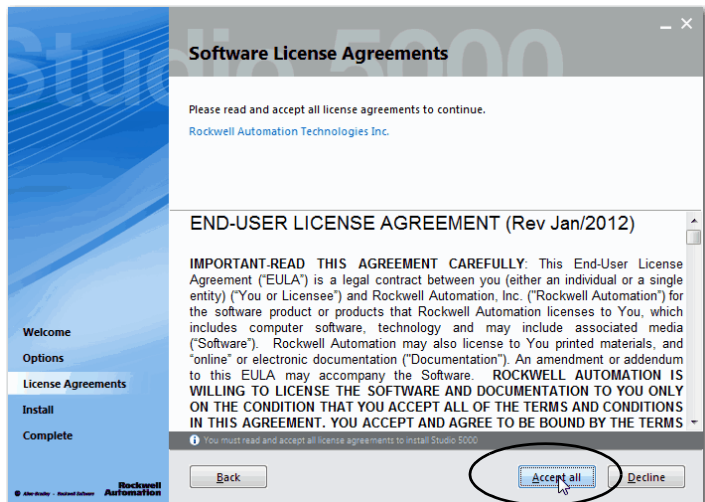

Among other software, your computer will have the following:

- Studio 5000 Environment, version 21.00.00

The Studio 5000 Environment, version 21.00.00 includes Logix Designer application, version 21.00.00.

- RSLinx Classic software, version 3.51.00
- RSNetWorx for DeviceNet, version 21.00.00

You are prompted to activate the software. For more information on software activation, see the following:

- FactoryTalk® Activations Frequently Asked Questions, publication [FTALK-FA017](#)
- Rockwell Automation Technical Support Software Activations site <http://www.rockwellautomation.com/support/activations.html>

## Automatic Installation of ControlFLASH Software

ControlFLASH software is used to upgrade a CompactLogix 5370 L2 controller's firmware revision. ControlFLASH software is automatically installed when you install the Studio 5000 environment.

For more information on loading firmware on your controller, see [Load the Controller Firmware on page 42](#).



## Configure an EtherNet/IP Driver in RSLinx Classic Software

1. Start the software.

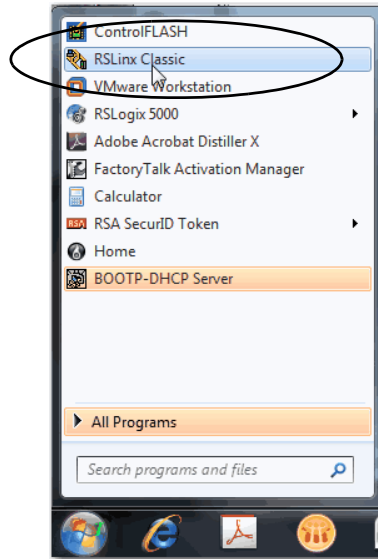

2. From the Communications menu, choose Configure Drivers.

The Configure Drivers dialog box appears.

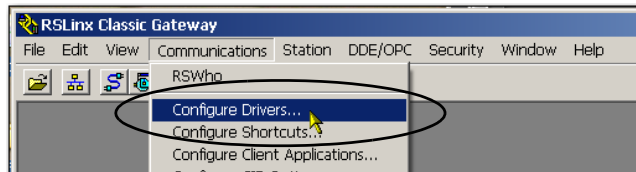

3. From the Available Driver Types pull-down menu, choose EtherNet/IP Driver or Ethernet devices and click Add New.

We recommend that you use EtherNet/IP Driver.

The Add New RSLinx Classic Driver dialog box appears.

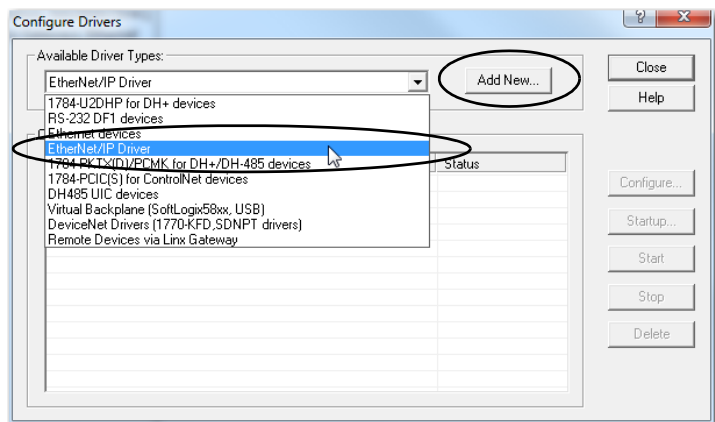

- Click OK to keep the default name.

The Configure driver:AB\_ETHIP-x dialog box appears. The full name of the dialog box varies by what driver type was chosen in [step 3](#).

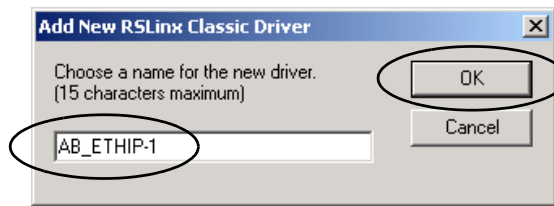

This example uses the EtherNet/IP Driver; the driver name is AB\_ETHIP-1.

- Select an Ethernet card and click OK.

This new driver is available.

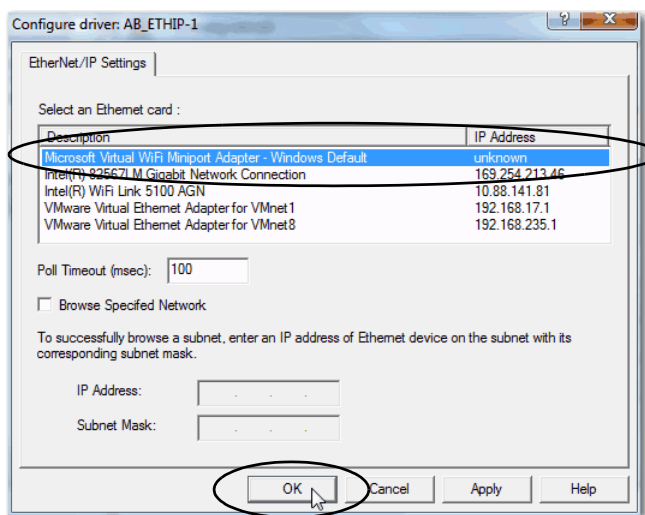

- Verify that the driver's Status is Running and click Close.

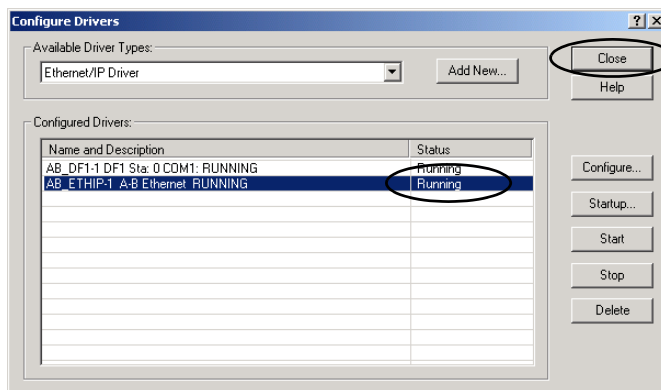

## Set the IP Address for the Computer

Your computer requires an Internet Protocol (IP) address to operate on an EtherNet/IP network. The IP address uniquely identifies the controller and is in the form *xxx.xxx.xxx.xxx* where each *xxx* is a number from 000...254 with some exceptions for reserved values.

A computer's IP address can be set automatically or manually. The manual option is typically used with isolated networks. This section describes how to set the IP address manually.

1. On your desktop, right-click Network and choose Properties.

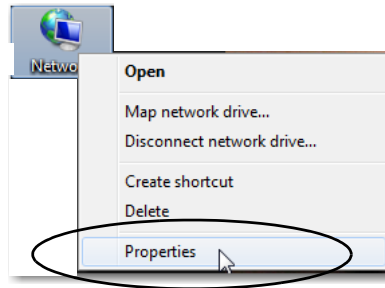

2. Click adapter settings.

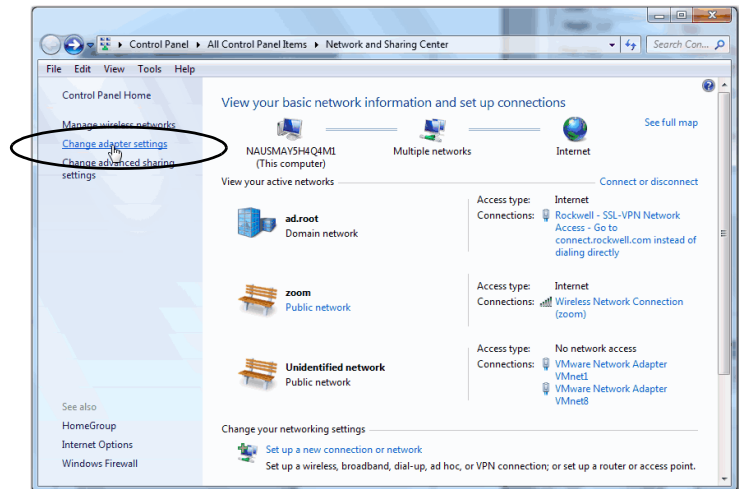

3. Right-click Local Area Connection and choose Properties.

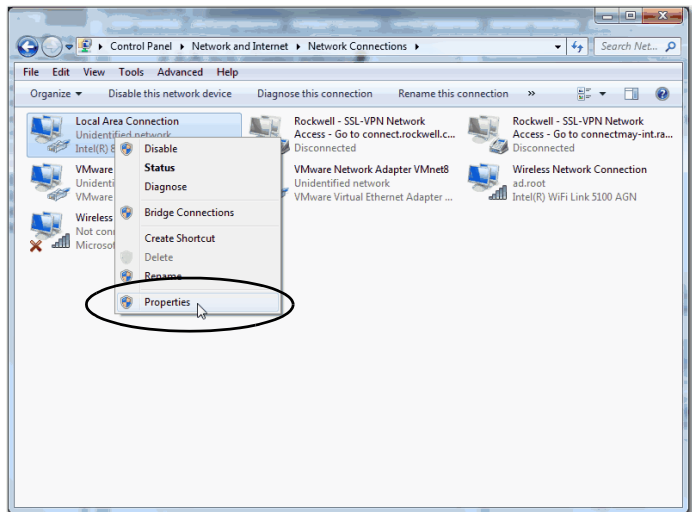

4. On the Networking tab, choose Internet Protocol Version 4 (TCP/IPv4) and click Properties.

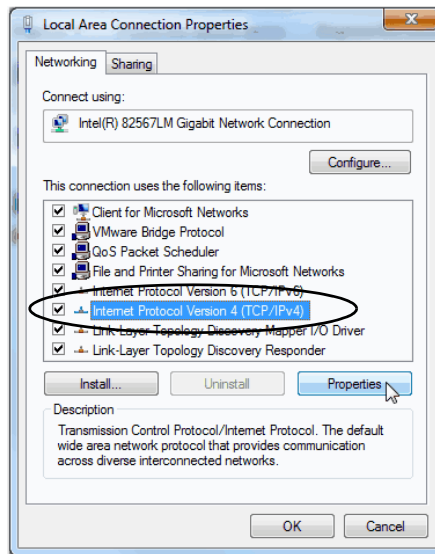

5. Select Use the following IP address and enter an IP address and Subnet mask for your computer.
6. Record the IP address and subnet mask.
7. Click OK.
8. Close the Local Area Connection Properties dialog box.

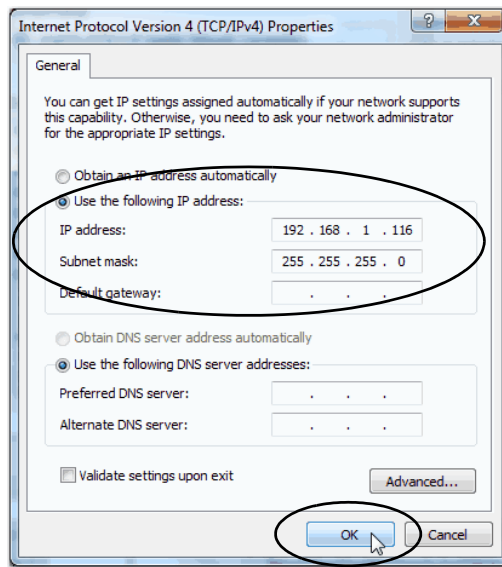

## Load the Controller Firmware

**IMPORTANT** This section assumes that you downloaded the controller firmware from the Rockwell Automation technical support website to install on your CompactLogix 5370 L2 controller. If not, download the firmware before following the steps in this section.

The firmware is available with the Logix Designer application or you can download it from the support website. Go to <http://www.rockwellautomation.com/support/>

This section describes how to load firmware on your CompactLogix 5370 L2 controller before setting an IP address for the controller. In this case, you must connect from your workstation to the controller over the USB port.

With this quick start, you must use RSLinx Classic software, version 3.51.00 or later with CompactLogix 5370 L2 controllers. When the software is installed, a USB driver is automatically installed. When your computer is connected to the CompactLogix 5370 L2 controller over a USB connection, the controller appears in the RSWho window whenever you perform a Browse.

1. Verify that the SD card in the controller is unlocked.
2. Connect to the controller via the USB port as described in [Make a USB Connection on page 27](#).

The controller should be powered. If it is not, turn power on to the controller.

3. Start the ControlFLASH software.

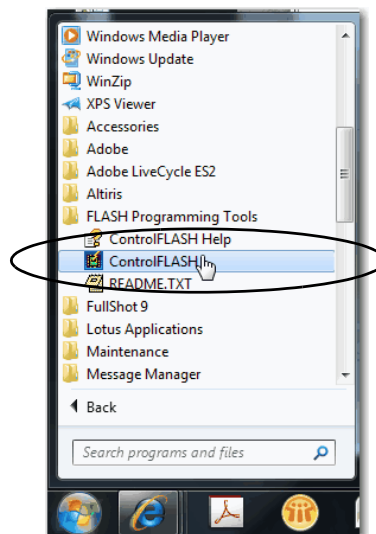

4. Click Next.

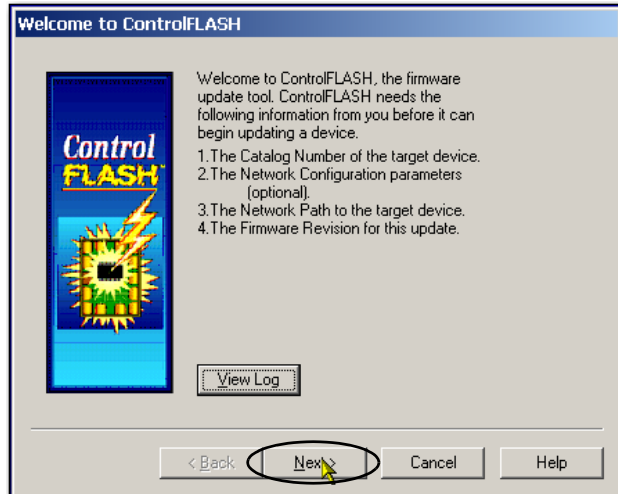

5. Select the controller catalog number and click Next.

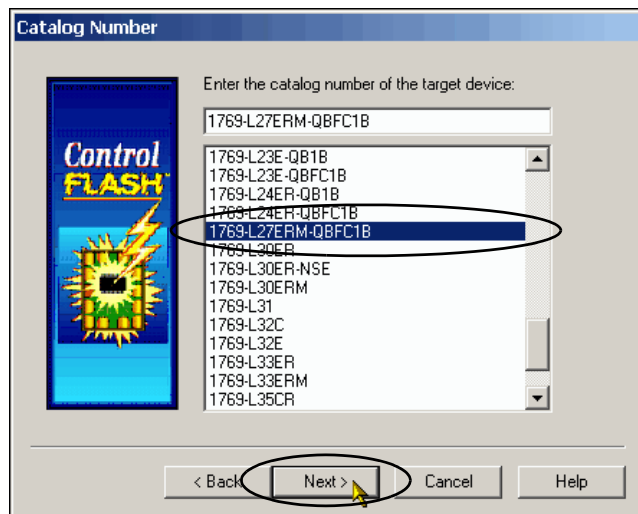

6. Expand the USB driver, and choose your controller.

7. Click OK.

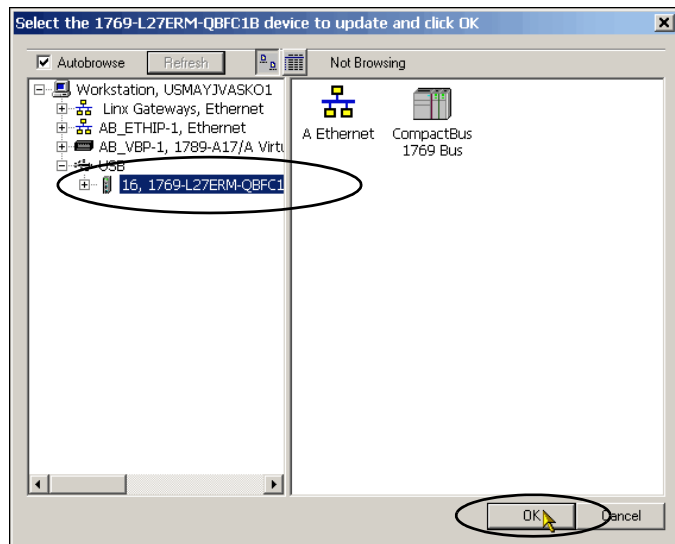

8. Verify that your controller's mode switch is in the REM position.

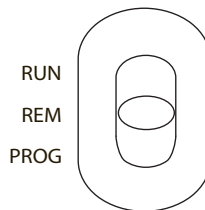

9. Choose the desired firmware revision and click Next.

**TIP** Consider the following:

- If the Current Revision matches the firmware revision shown in the box below it, click Cancel. You are finished with this task.
- This example uses firmware revision 21.001.23. Your firmware revision may be a different number. You can access the latest firmware revision at the Rockwell Automation Technical Support webpage.

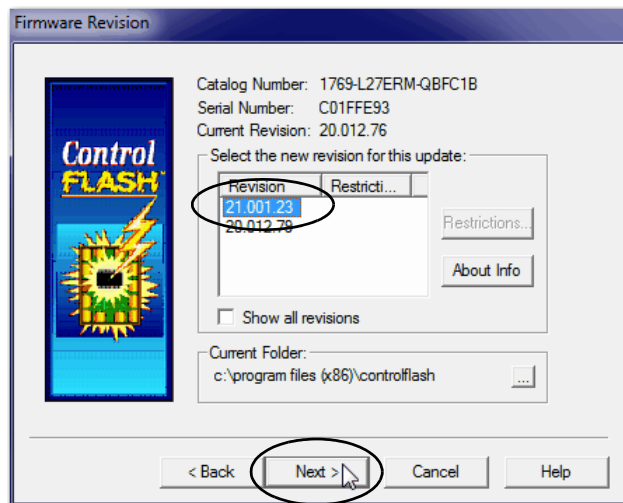



- To start the firmware update, click Finish and then click Yes.

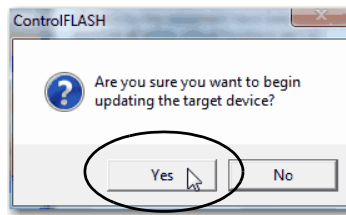
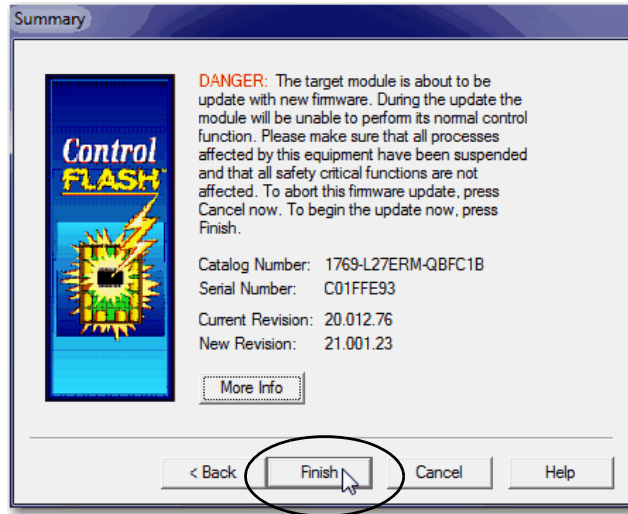

Before the firmware upgrade begins, you an Attention dialog box. Take the appropriate action for your application. In this example, the upgrade continues when OK is clicked.

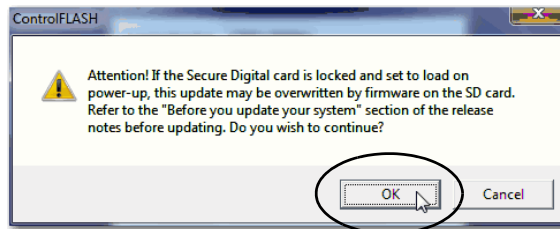

After the controller is updated, the status dialog box displays the message Update complete.

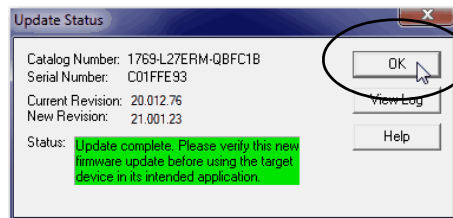

---

**IMPORTANT** The firmware revision shown in this quick start might not match the firmware revisions available for the CompactLogix 5370 L2 controllers.

---

11. Click OK.

12. To close the ControlFLASH software, click Cancel and then click Yes.

## Install Additional Software

Depending on your application, you may need to install additional software.

For example, if you are integrating a PanelView Plus terminal into your system, you must install the following:

- RSLinx Enterprise software

---

**IMPORTANT** You must install this software before you install any other additional software.

---

- FactoryTalk View Machine Edition software

## Configure the EtherNet/IP Network

In this chapter, you assign an IP address to your CompactLogix 5370 L2 controller.

This quick start does not use other devices on the EtherNet/IP network. It is not uncommon, however, to use other devices on an EtherNet/IP network in a CompactLogix 5370 L2 control system. If you were to do so, for example, use PanelView Plus terminal on an EtherNet/IP network, you need to assign an IP address to each device.

---

**IMPORTANT** Not all tasks described in this quick start are required to complete the final task, that is, use ladder logic to test a 1769-OB16 output module as described beginning on [page 63](#). For example, you do not need to install an EtherNet/IP network to connect to a CompactLogix 5370 L2 controller because you can do so over a USB cable.

We expect that you might attempt to complete additional tasks with your control system by using the publications listed on [page 11](#) relating to using a component over an EtherNet/IP network in a Logix5000 control system. When you use those publications, some assumptions are made. For example, if you use POINT I/O modules over an EtherNet/IP network in a CompactLogix 5370 L2 control system, you must have already created a Logix Designer project and have an IP address assigned to the controller.

If you complete all of the tasks described in this chapter, you can easily complete the tasks described in the publications listed on page 11 related to using an EtherNet/IP network.

---

## Before You Begin

Before you begin, complete these tasks:

- The tasks described in Chapter 1, [Prepare the CompactLogix 5370 L2 Controller Hardware on page 17](#), including the following:
  - Install the EtherNet/IP network.
  - Install the controller and the local expansion 1769-OB16 output module.
  - Wire power to the controller.
  - Make network connections.

---

**IMPORTANT**

If you connect all of the devices, including the computer, through an Ethernet switch, you can create an isolated network. This chapter assumes you are using an isolated network. If you are not, contact your network administrator to obtain IP addresses.

---

- The tasks described in Chapter 2, [Prepare the Computer and Load Controller Firmware on page 31](#), including the following:
  - Install the Studio 5000 environment and RSLinx Classic software.  
Logix Designer application is installed when you install the Studio 5000 environment.
  - Configure an EtherNet/IP driver in RSLinx Classic software.
  - Set the IP address for the computer.
  - Load firmware on the controller.
- Verify that power is applied to all devices.

## What You Need

[Table 7](#) lists the software components you use in this chapter.

**Table 7 - What You Need to Configure the EtherNet/IP Network**

Component	Description
Studio 5000 environment	Environment that combines engineering and design elements into a common environment.
Logix Designer application	Software used to create a project the CompactLogix 5370 L2 controller used in your application.
RSLinx Classic software	Communication software that supports multiple software applications simultaneously, establishing communication between devices on many different Allen-Bradley industrial networks.
IP Address	<p>A number in the form <i>xxx.xxx.xxx.xxx</i> where each <i>xxx</i> is a number from 000 . . . 254.</p> <p>The IP address uniquely identifies the controller on the EtherNet/IP network.</p>
Subnet Mask	<p>Extension of the IP address that allows a site to use a single network ID for multiple physical networks.</p> <p>If you change the subnet mask of a configured controller, you must cycle power to the controller for the change to take effect.</p>

## Assign an IP Address to the Controller over a USB Connection

At initial powerup, the CompactLogix 5370 L2 controller does not have an IP address. Use RSLinx Classic software over a USB connection to assign an IP address. The following steps will work only if the computer with RSLinx Classic software is connected to the controller via a USB connection.

**IMPORTANT** There are other methods to assign an IP address to the controller, such as using the BOOTP/DHCP utility. This section is only one example of how to assign the IP address to the controller.

For more information on the methods to assign an IP address to the CompactLogix 5370 L2 controller, see the CompactLogix 5370 Controllers User Manual, publication [1769-UM021](#).

1. Verify that your computer is connected to the USB port on the front of the controller.
2. From the Communications menu, choose RSWho.

The RSWho dialog box appears.

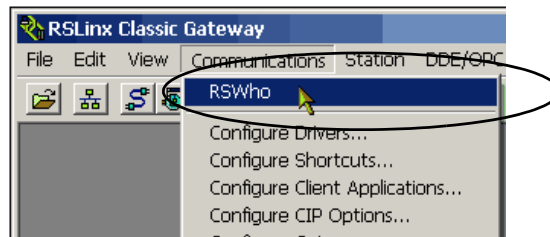

3. Navigate to the USB connection.
4. Right-click the controller and choose Module Configuration.

The Module Configuration dialog box appears.

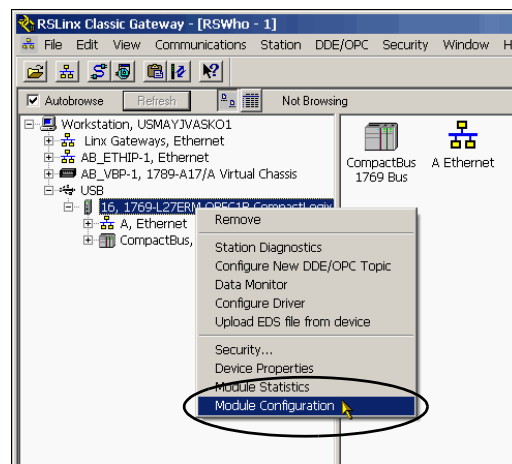

5. Click the Port Configuration tab.
6. For Network Configuration Type, click Static to permanently assign this configuration to the port.

---

**IMPORTANT** The controller's default configuration is Dynamic. When the controller is configured for Dynamic, on a power cycle, it clears the current IP address and resumes sending BOOTP requests.

---

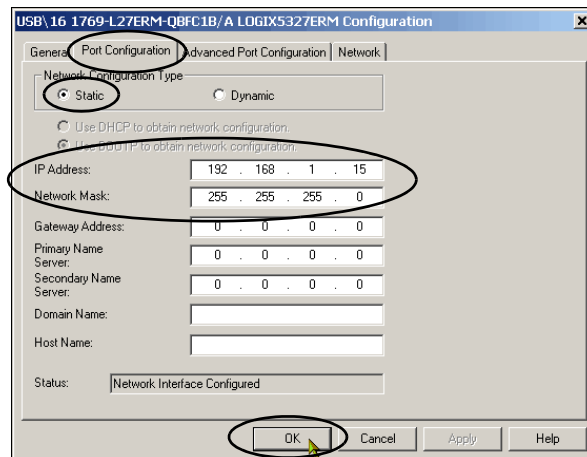

7. Enter the IP address and Network Mask for the controller.
8. Enter other network parameters, if desired.
9. Click OK.

For more information on setting the network IP address, see EtherNet/IP Network Configuration User Manual, publication [ENET-UM001](#).

**Notes:**



## Configure the DeviceNet Network

In this chapter, you configure the DeviceNet node address for the 1769-SDN scanner module. You also create the RSNetWorx for DeviceNet file that stores network configuration.

---

**IMPORTANT** Not all tasks described in this quick start are required to complete the final task, that is, use ladder logic to test a 1769-OB16 output module as described beginning on [page 63](#). For example, you do not need a DeviceNet configuration file to test the module.

We expect that you might attempt to complete additional tasks with your control system by using the publications listed on [page 11](#) relating to using a component over a DeviceNet network in a Logix5000 control system. When you use those publications, some assumptions are made. For example, if you use POINT I/O modules over a DeviceNet network in a CompactLogix 5370 L2 control system, you must have already created a Logix Designer project and created a DeviceNet configuration file.

If you complete all of the tasks described in this chapter, you can easily complete the tasks described in the publications listed on page 11 related to using a DeviceNet network.

---

### Before You Begin

Before you begin, complete these tasks:

- The tasks described in Chapter 1, [Prepare the CompactLogix 5370 L2 Controller Hardware on page 17](#), including the following:
  - Install the DeviceNet network.
  - Install the controller and the local expansion 1769-OB16 and 1769-SDN modules.
  - Wire power to the controller.
  - Make network connections.

- The tasks described in Chapter 2, [Prepare the Computer and Load Controller Firmware on page 31](#), including the following:
  - Install the Studio 5000 environment and RSLogix Classic software.  
Logix Designer application is installed when you install the Studio 5000 environment.
  - Load firmware on the controller.
- Verify that power is applied to all devices.

## What You Need

[Table 8](#) lists the components you use in this chapter.

**Table 8 - What You Need to Configure the DeviceNet Network**

Component	Description
RSNetWorx for DeviceNet software	Configuration software that creates a scanlist of devices that exchange information with the controller over a DeviceNet network.
DeviceNet power components	Components necessary to power the DeviceNet network.  This example uses the 1606-XLDNET8 and a KwikLink power tap module.

# Follow These Steps

[Apply Power to the DeviceNet Network](#)

[page 56](#)

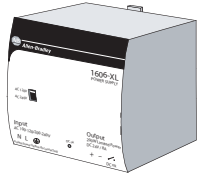

[Set the 1769-SDN Scanner Module's Node Address](#)

[page 57](#)

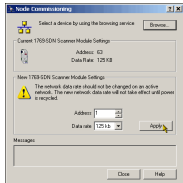

[Create a DeviceNet Configuration File](#)

[page 59](#)

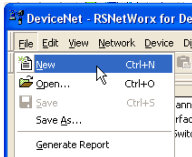

## Apply Power to the DeviceNet Network

In this quick start, the CompactLogix 5370 L2 control system uses a 1606-XLDNET8 DeviceNet power supply to power the DeviceNet network. You completed the tasks described in [Make a DeviceNet Network Connection on page 29](#) to install the power supply and other components in the DeviceNet network, such as a KwikLink sealed terminator on each end of the KwikLink flat cable.

---

**IMPORTANT** Verify that you installed termination resistors on both ends of the DeviceNet network.

---

Turn on incoming power to the DeviceNet network.

This chapter describes how to configure a DeviceNet network that includes only a 1769-SDN scanner module.

The example graphic shows a DeviceNet network with additional devices on the network.

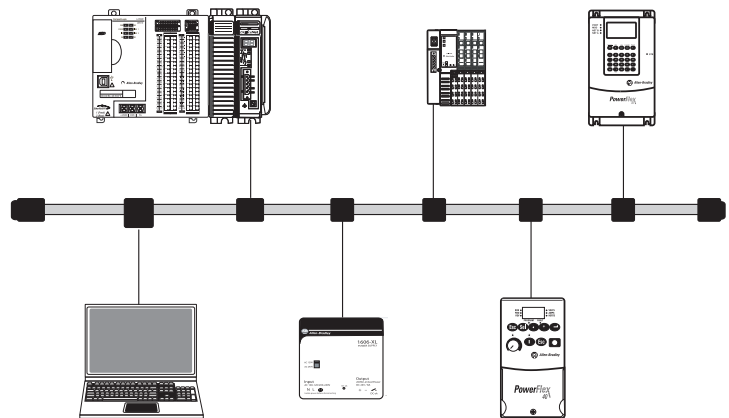

## Set the 1769-SDN Scanner Module's Node Address

1. Start the software.

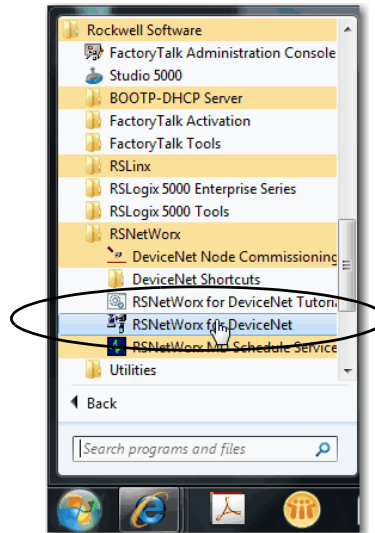

2. From the Tools menu, choose Node Commissioning.

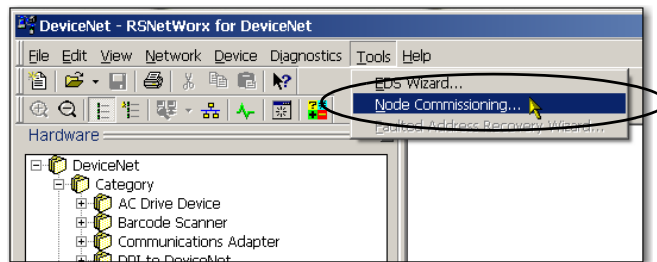

3. Click Browse.

When the Device Selection dialog box appears, you can browse to the 1769-SDN scanner module over an EtherNet/IP network or USB connection. This example uses an EtherNet/IP network connection.

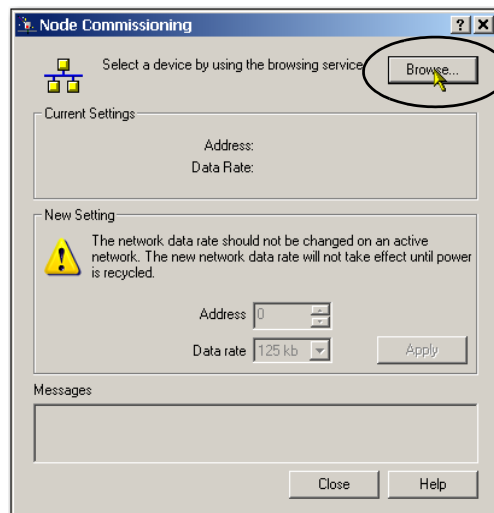

4. Under the AB\_ETHIP-1 driver, expand the path to the 1769-SDN scanner module as shown in the example graphic.
5. Click OK.

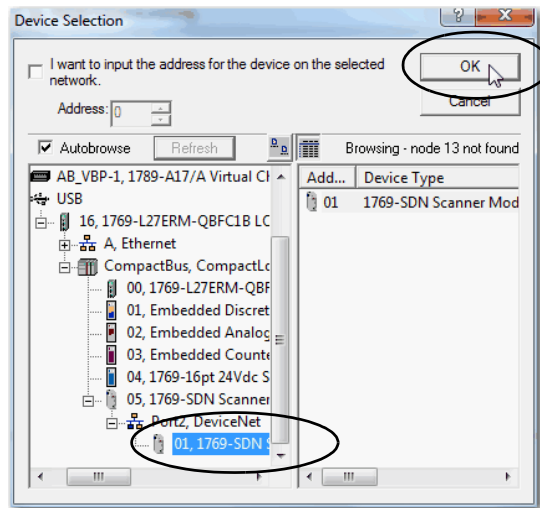

6. If you receive a linking device warning, click Yes.

The Node Commissioning dialog box is populated with the 1769-SDN module's current settings.

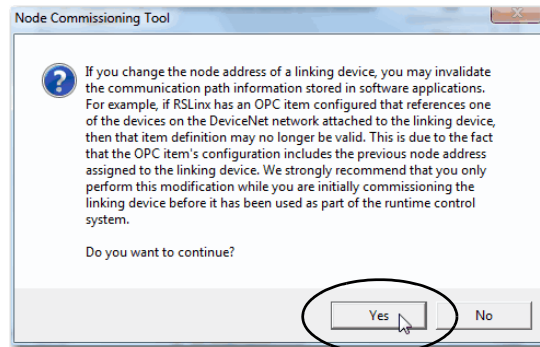

7. Enter a node address of 1 for the 1769-SDN scanner module and click Apply.

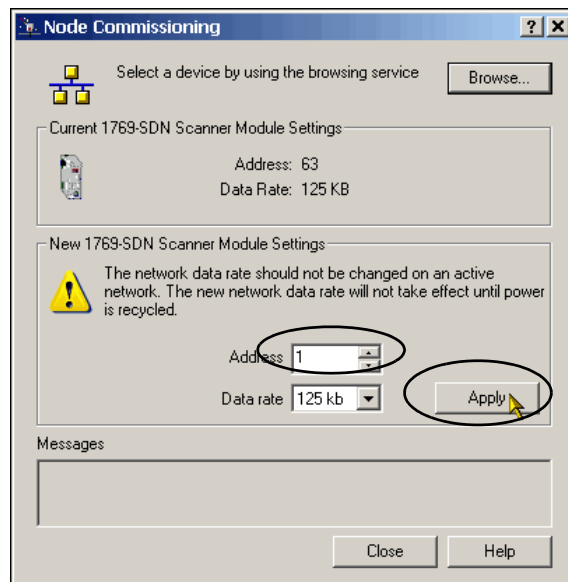

The Address is applied and is confirmed in the Messages box.

8. Record the node address.
9. Click Close.

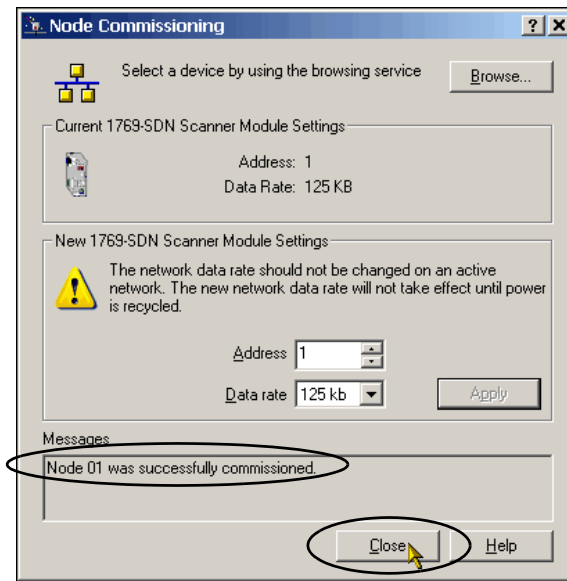

## Create a DeviceNet Configuration File

1. From the File menu, choose New.

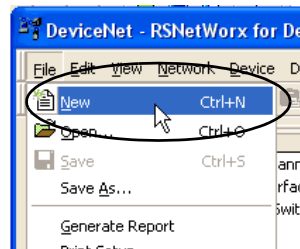

2. Click Who Active to go online.

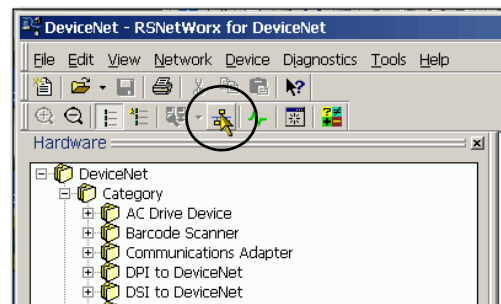

3. Expand the networks to the appropriate DeviceNet network.

In this example, the network is Port 2, DeviceNet.

4. If desired, record following information about the 1769-SDN scanner module:

- Slot number in the CompactBus = 5
- DeviceNet network node number = 1

If you do not need this information, skip to [step 5](#).

5. Click OK.

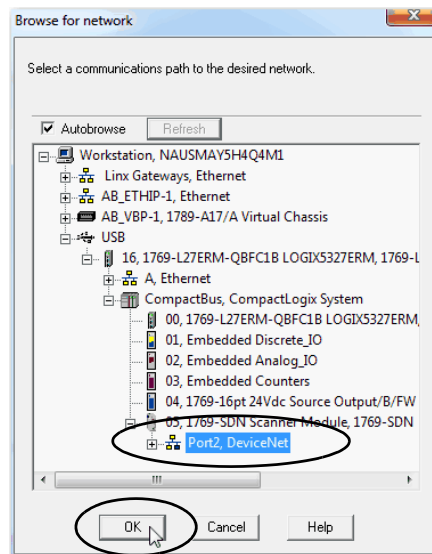
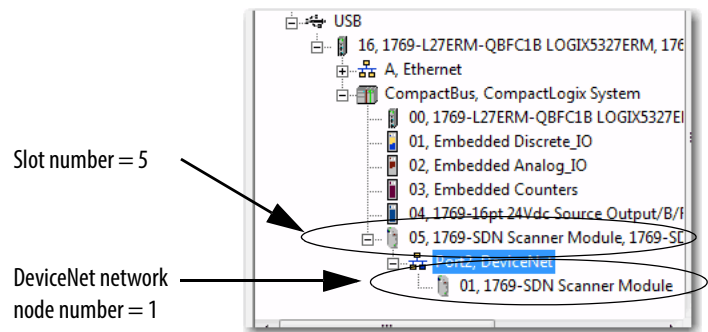



- Click OK when the alert about uploading or downloading device information.

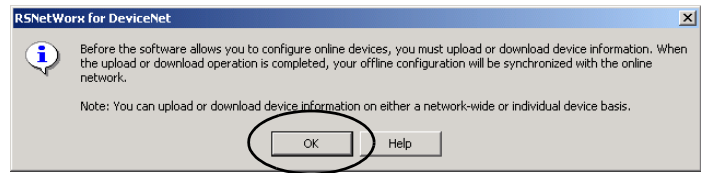

RSNetWorx for DeviceNet software browses the network and shows the 1769-SDN scanner module at DeviceNet network node number 1.

- Right-click the 1769-SDN scanner module and choose Properties.

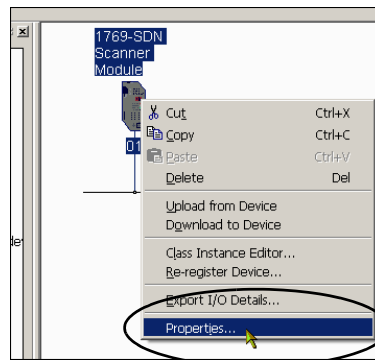

- Click the Module tab.

The information for your DeviceNet scanner module may vary from what is shown here.

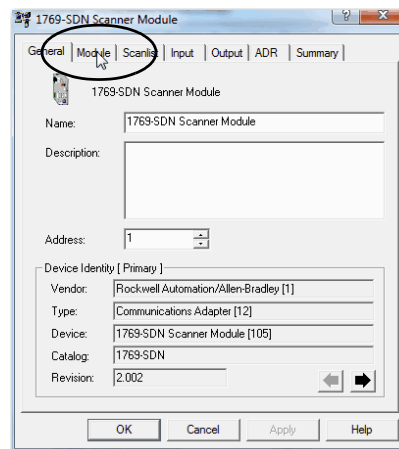

9. Click Download.

All configuration is cleared from the 1769-SDN scanner module, and the software is synchronized with the module.

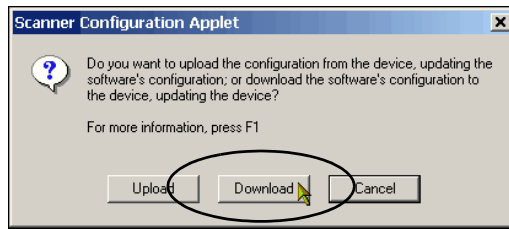

10. From the Platform pull-down menu, choose CompactLogix.

11. Enter the slot number of the 1769-SDN scanner module.

12. Click OK.

13. Save the file and record the file name and path.

This quick start uses the example file name DeviceNet.dnt.

14. Close RSNetWorx for DeviceNet software.

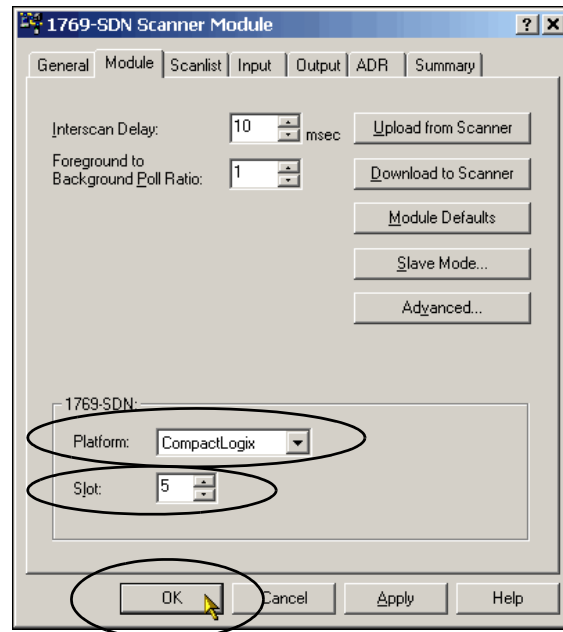

## Create a Logix Designer Project

In this chapter you create a Logix Designer project. In the project you use ladder logic to create a push button that controls a light on a digital output module.

You learn how to complete the following tasks:

- Create a Logix Designer project.
- Configure your 1769-L27ERM-QBFC1B controller.
- Add a local expansion module to the project.
- Add a 1769-SDN scanner module to the project.
- Add ladder logic to the project to test the local expansion module.
- Download the project to the controller.

---

**IMPORTANT** Consider the following before you complete the tasks in this chapter:

- You must use the Logix Designer application with any CompactLogix 5370 L2 control system. The tasks in this chapter are described with the intention that you might reuse the project to complete tasks described in publications listed on [page 11](#).

For example, you are not required to add a 1769-SDN scanner module to your project to use ladder logic to test the local expansion module. The tasks to add the scanner module are described so you can easily use the project from this quick start with one of the publications listed on [page 11](#) related to using a DeviceNet network.

- The tasks that are described in this chapter are done so to work with a local expansion module. You can complete the same tasks with the embedded digital output module.

For the purposes of using this quick start, we recommend that you use the local expansion module.

---

## Before You Begin

Before you begin, complete these tasks:

- The tasks described in Chapter 1, [Prepare the CompactLogix 5370 L2 Controller Hardware on page 17](#), including the following:
  - Install the EtherNet/IP network.
  - Install the controller and the local expansion module.
  - Wire power to the controller.
- The tasks described in Chapter 2, [Prepare the Computer and Load Controller Firmware on page 31](#), including the following:
  - Install the Studio 5000 environment and RSLinx Classic software.  
Logix Designer application is installed when you install the Studio 5000 environment.
  - Configure an EtherNet/IP driver in RSLinx Classic software.
  - Set the IP address for the computer.
  - Load firmware on the controller.
- Set the IP address for the controller as described on [page 50](#).
- Verify that all devices are powered.

## What You Need

You need the Logix Designer application to complete the tasks in this chapter and create a Logix Designer project.

# Follow These Steps

[Create a Project](#)

[page 66](#)



[Configure the Controller](#)

[page 68](#)

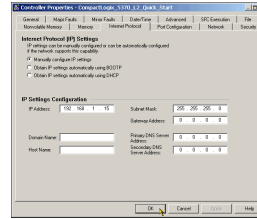

[Add the Local Expansion Module](#)

[page 70](#)

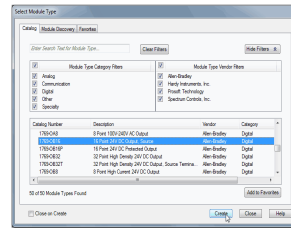

[Add the 1769-SDN Scanner Module \(optional\)](#)

[page 71](#)

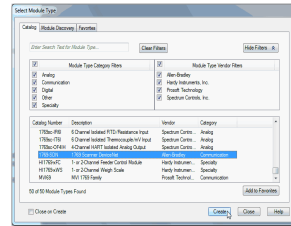

[Add Ladder Logic to Use the Local 1769-OB16 Module](#)

[page 74](#)

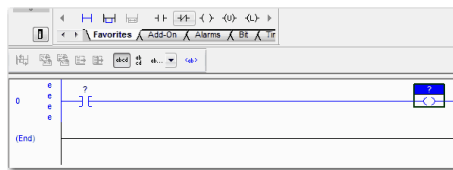

[Download the Project to the Controller and Test the Logic](#)

[page 77](#)

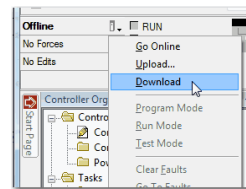

## Create a Project

1. Start the application.

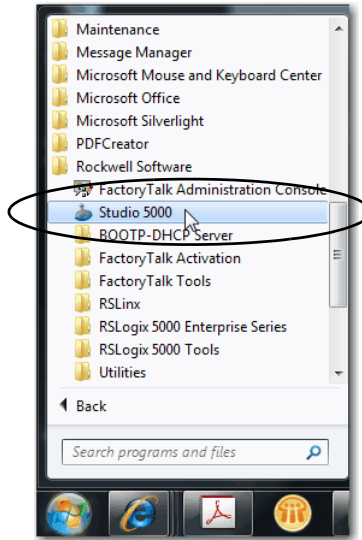

2. Click New Project.

The New Project dialog box appears.



3. Choose your controller and name the project.

4. Click Next.

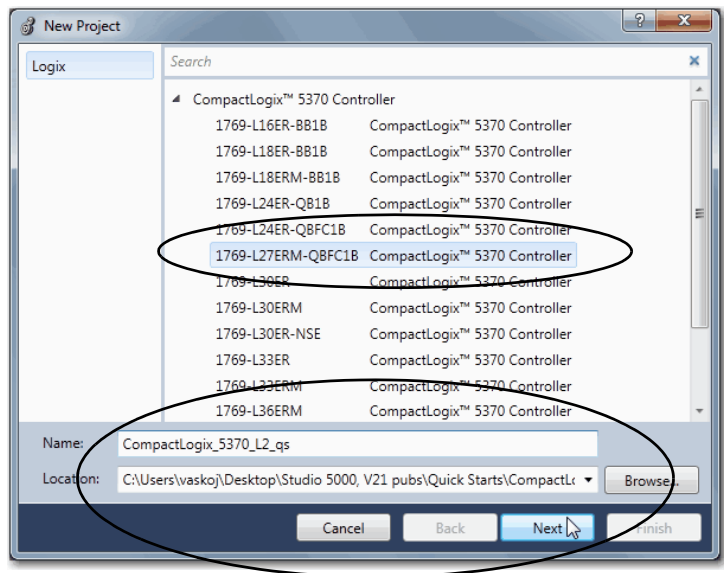

5. Choose a Security Authority and click Finish.

For the purposes of this publication, we recommend that you choose No Protection, as shown.

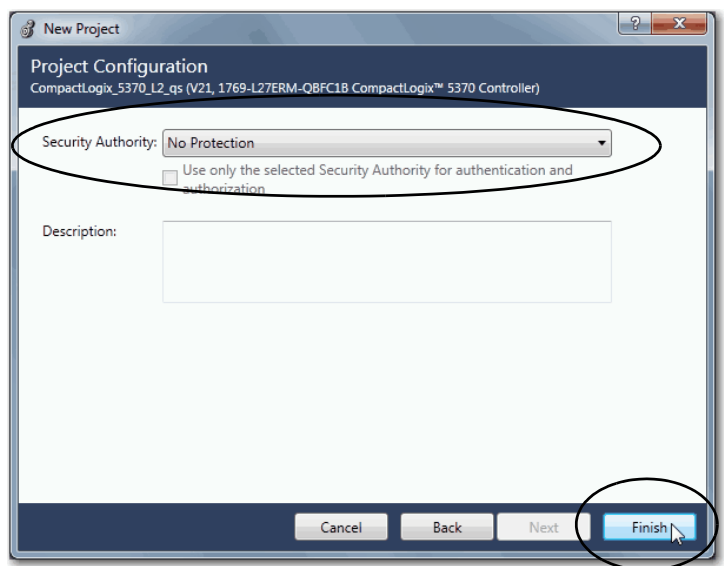

## Configure the Controller

1. Verify that your controller's mode switch is in the REM position.

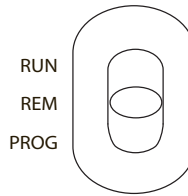

2. Click the RSWho icon.



3. In the Who Active dialog box, expand the path to the controller and select it.

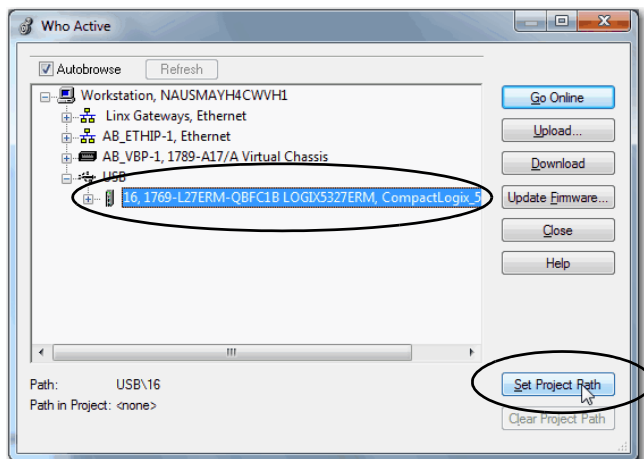

4. Click Set Project Path.

5. Click Download.

6. Click Download again when the Download dialog box appears.

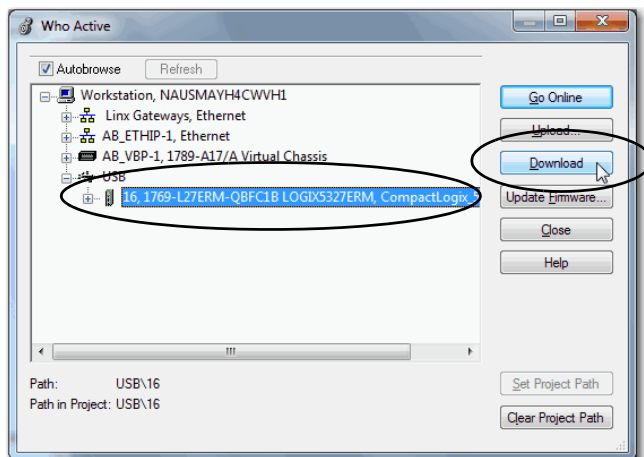

**IMPORTANT** After the download is complete, the controller goes online. You must be online to set the controller's IP address as described in [step 8](#)...[step 10](#).



7. If prompted, click Yes to change the controller mode to Remote Run.

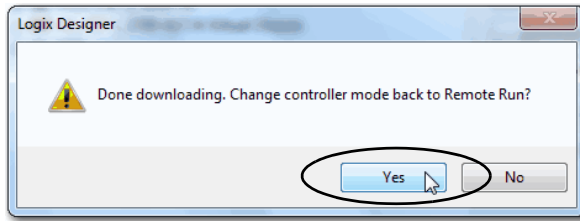

8. Expand the I/O Configuration tree.

9. Right-click the controller and choose Properties.

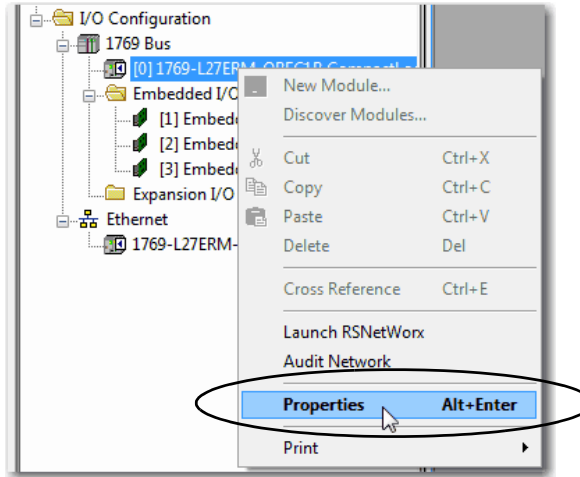

10. Use the tabs on the Controller Properties dialog box to configure the controller.

The IP address is set on the Internet Protocol tab.

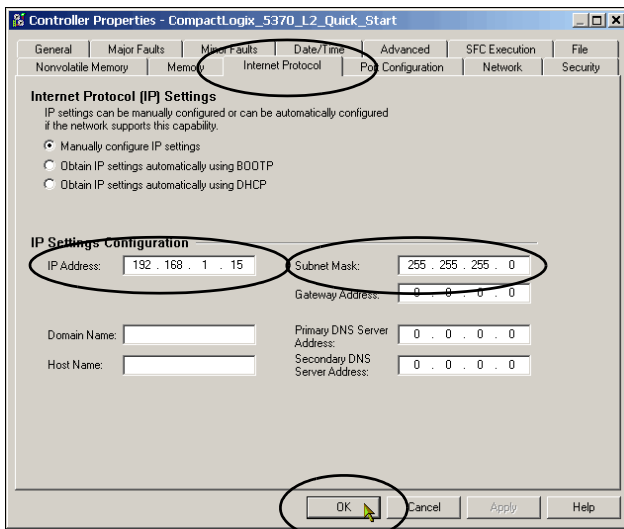

---

**IMPORTANT** Make sure you set the controller's IP Address and Subnet Mask to values that match the values set in [Assign an IP Address to the Controller over a USB Connection on page 50.](#)

---

For more information describing how to use all of the tabs on the Configuration Properties dialog box, see the CompactLogix 5370 Controller User Manual, publication [1769-UM021](#).

11. Save the project and go offline.

## Add the Local Expansion Module

1. Right-click Expansion I/O and choose New Module.

The Select Module Type dialog box appears.

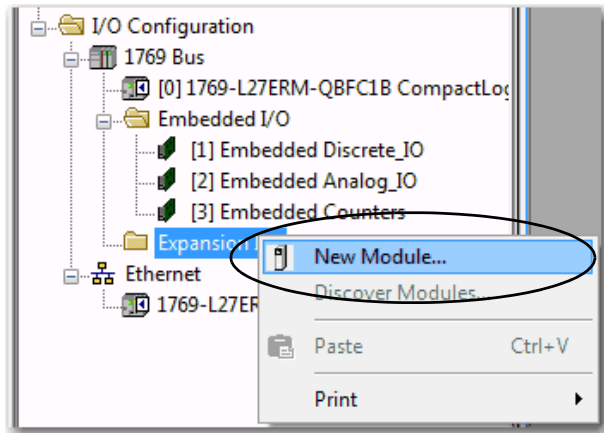

2. Select the 1769-OB16 Compact I/O output module and click Create.

The New Module dialog box appears for the module created.

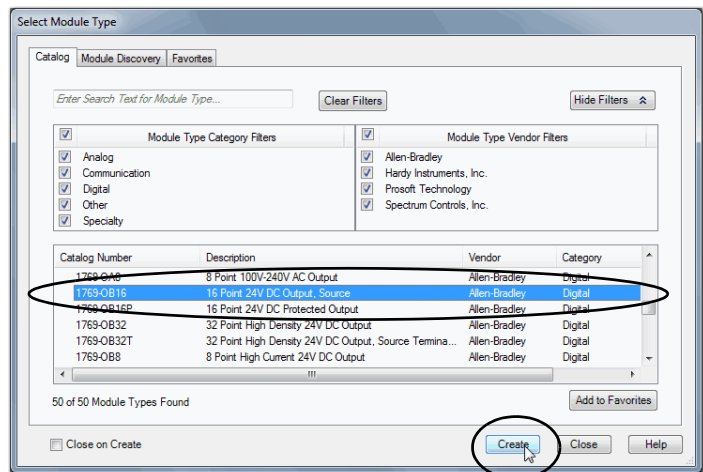

- Use the tabs to create the parameters for the I/O module.

**IMPORTANT** For the purposes of this quick start, make sure you change the Module Definition parameters so Electronic Keying is set to Disable Keying.

- When the module configuration is complete, click OK.

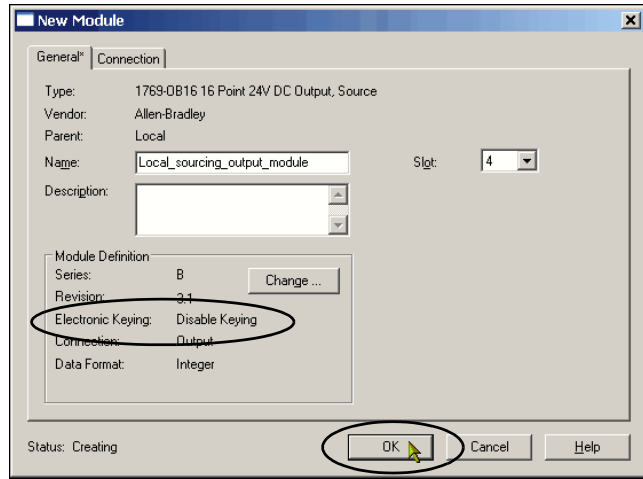

The module is added to the I/O Configuration.

## Add the 1769-SDN Scanner Module (optional)

**IMPORTANT** You are not required to add the 1769-SDN scanner module to complete the tasks described in this chapter. You might use some of the publications listed in [Table 1 on page 11](#) that require a Logix Designer project that includes a DeviceNet network with a CompactLogix 5370 L2 controller. If you add the scanner module to this project, you can easily use it with those publications.

If you do not intend to use a DeviceNet network with a CompactLogix 5370 L2 controller in the future, skip this section and go to [Add Ladder Logic to Use the Local 1769-OB16 Module on page 74](#).

- Right-click Expansion I/O and choose New Module.

The Select Module Type dialog box appears.

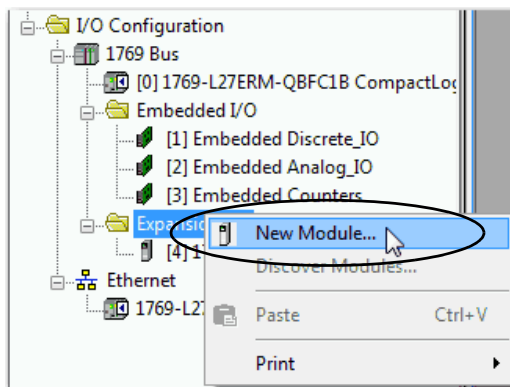

2. Select the 1769-SDN scanner module and click Create.

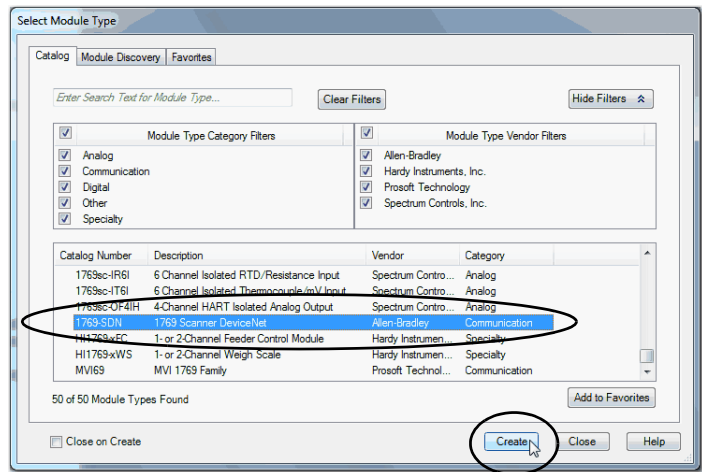

3. Select the 1769-SDN scanner module's major revision and click OK.

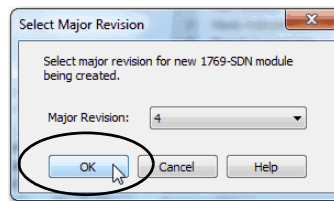

4. When the New Module dialog box appears, configure the 1769-SDN scanner module.

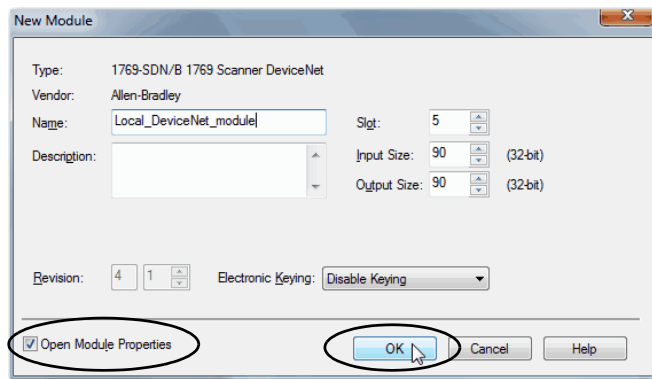

5. Check the Open Module Properties checkbox and click OK.

Additional tabs with configurable parameters appear.

6. On the RSNetWorx tab, click Browse to find the configuration (.dnt) file created in [Create a DeviceNet Configuration File on page 59](#).

This quick start uses New DeviceNet.dnt.

7. Click OK.

The module is added to the I/O Configuration.

8. Save the project.

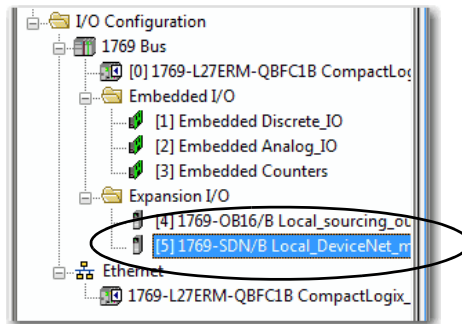
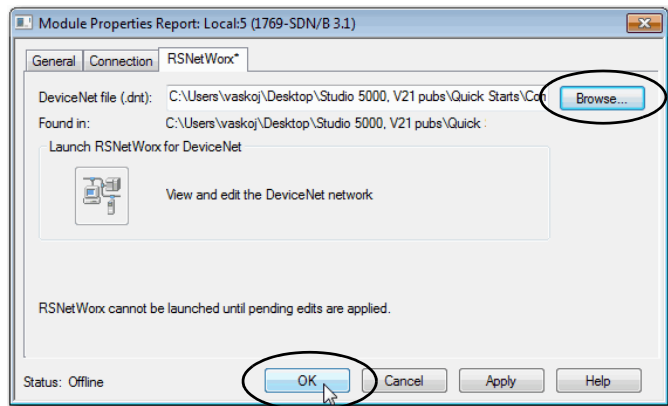

## Add Ladder Logic to Use the Local 1769-OB16 Module

1. Expand the Tasks folders.
2. Right-click MainRoutine and choose Open or double-click on Main Routine.

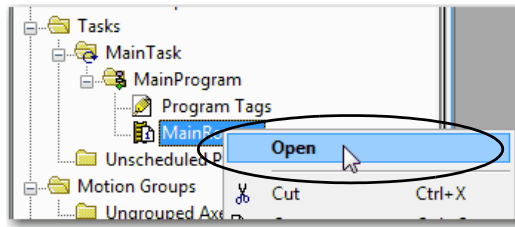

A blank MainRoutine opens.

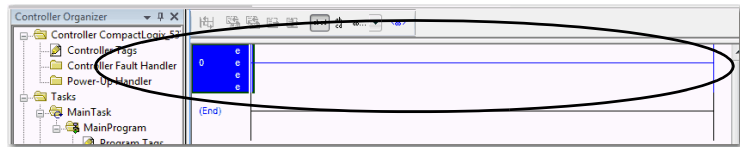

3. From the Element Toolbar, drag and drop an Examine On and an Output Energize element onto the rung.

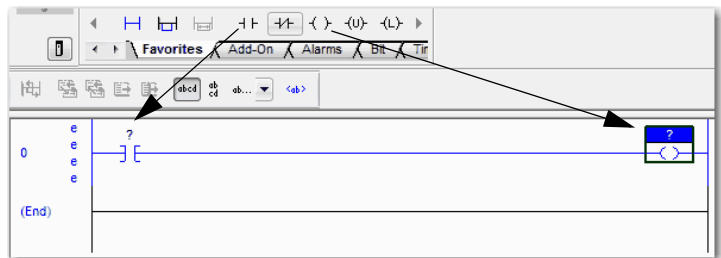

4. Double-click the ? in the Examine On element.
5. Type PB (for push button).
6. Press Enter.

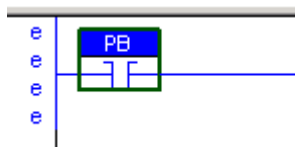
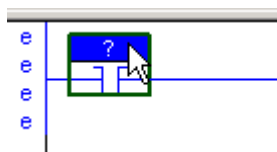

7. Right-click PB and choose New 'PB'.

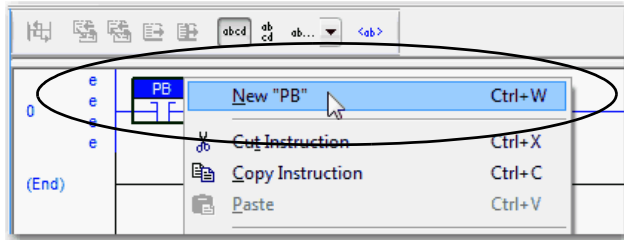

8. Click Create and Close.

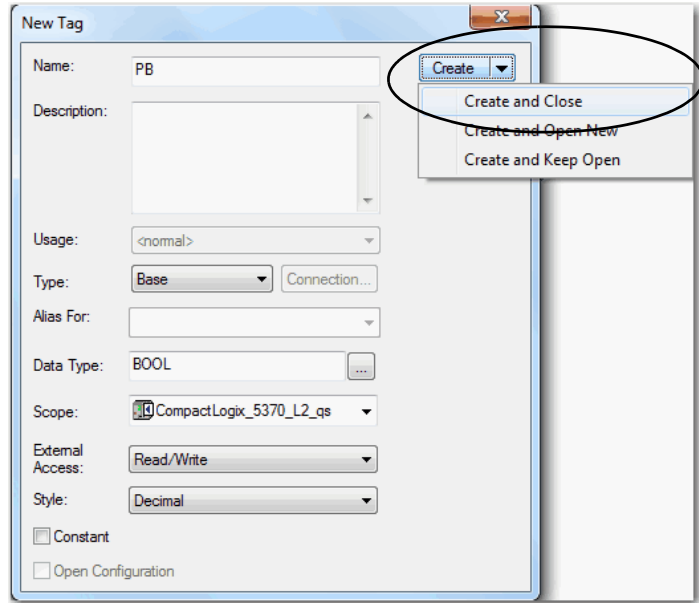

9. Double-click the ? in the Output Energize element.

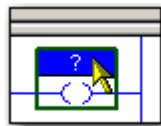

10. Name the Output Energize element OB16\_Light.

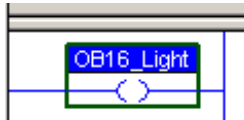



---

**IMPORTANT** Do not use spaces in the tag name. Use underscores (\_) instead.

---

11. Press Enter.

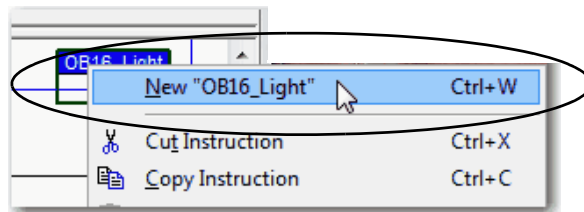
- Right-click the OB16\_Light tag name and choose New OB16\_Light.



OB16\_Light is an alias tag for the I/O point tag name. With an alias tag, you assign a simple name to a physical I/O point address.

- From the Type pull-down menu, choose Alias.
- In the Alias For pull-down menu, browse to the local 1769-OB16 output module choose any bit.

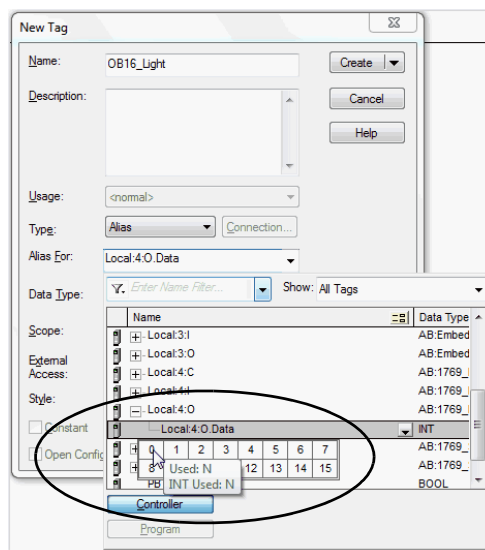

This example uses Local:4:O.Data.0.

- Click Create and Close.

- The graphic shows the Output Energize after assigning the Alias tag to a point on the output module.

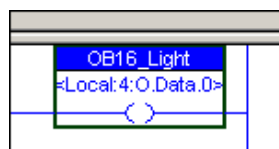

- Save your changes.



## Download the Project to the Controller and Test the Logic

1. From the mode pull-down menu, choose Download.
2. When the dialog box appears with information about the download, click Download.

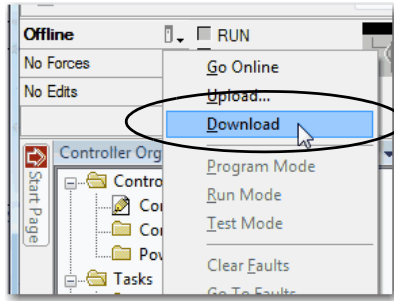

3. Click Yes to change the controller mode to Remote Run.

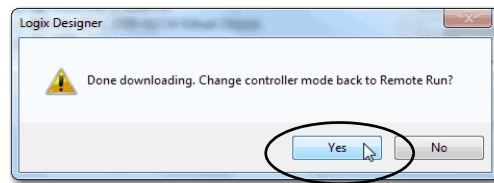

4. Move the mode switch on your controller to RUN.

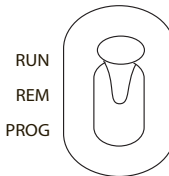

5. Select the PB Examine On instruction.

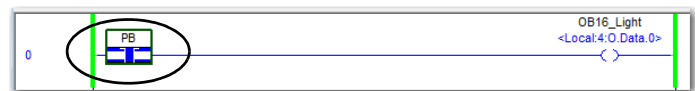

6. Press Ctrl+T to toggle the state from 0 to 1, or Off to On.

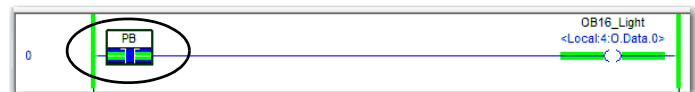

7. Verify that the status indicator on the digital output module turns on after you toggle the state to 1 or On.
8. Press Ctrl+T to toggle the state back to 0 or Off.
9. Save the project and go offline.

**Notes:**

## Understanding Other Application Options

This chapter describes two application options available with a CompactLogix 5370 L2 controller:

- Using the controller in a DLR network topology
- Using the controller in an application that includes Integrated Motion on an EtherNet/IP network - 1769-L27ERM-QBFC1B only

---

**IMPORTANT** This chapter does not describe specific steps required to use the CompactLogix 5370 L2 controller in applications with DLR networks or Integrated Motion over an EtherNet/IP network.

The purpose is to introduce you to these other applications.

---

See the following publications for more information on the application options:

- Using the controller in a DLR network topology:
  - CompactLogix 5370 Controllers User Manual, publication [1769-UM021](#)
  - EtherNet/IP Embedded Switch Technology Application Guide, publication [ENET-AP005](#)
- Using the controller in an application that includes Integrated Motion on an EtherNet/IP network:
  - CompactLogix 5370 Controllers User Manual, publication [1769-UM021](#)
  - CIP Motion Configuration and Startup User Manual, publication [MOTION-UM003](#)
  - Integrated Architecture and CIP Sync Configuration Application Technique, publication [IA-AT003](#)

## DLR Network Topology

A DLR network topology is a single-fault-tolerant ring network in which DLR-capable Allen-Bradley devices use embedded technology and dual EtherNet/IP ports to establish a network that is resilient to single points of failure, recovers faster when single faults occur, and does not require switches.

Configuring a DLR network topology requires you to complete a few tasks that do not apply to using a CompactLogix 5370 L2 controller in a linear or star network topology. For example, a DLR network topology requires that one supervisor-capable network device be configured as the active ring supervisor. CompactLogix 5370 L2 controllers are supervisor-capable devices on a DLR network.

This graphic shows a DLR network topology with a CompactLogix 5370 L2 controller.

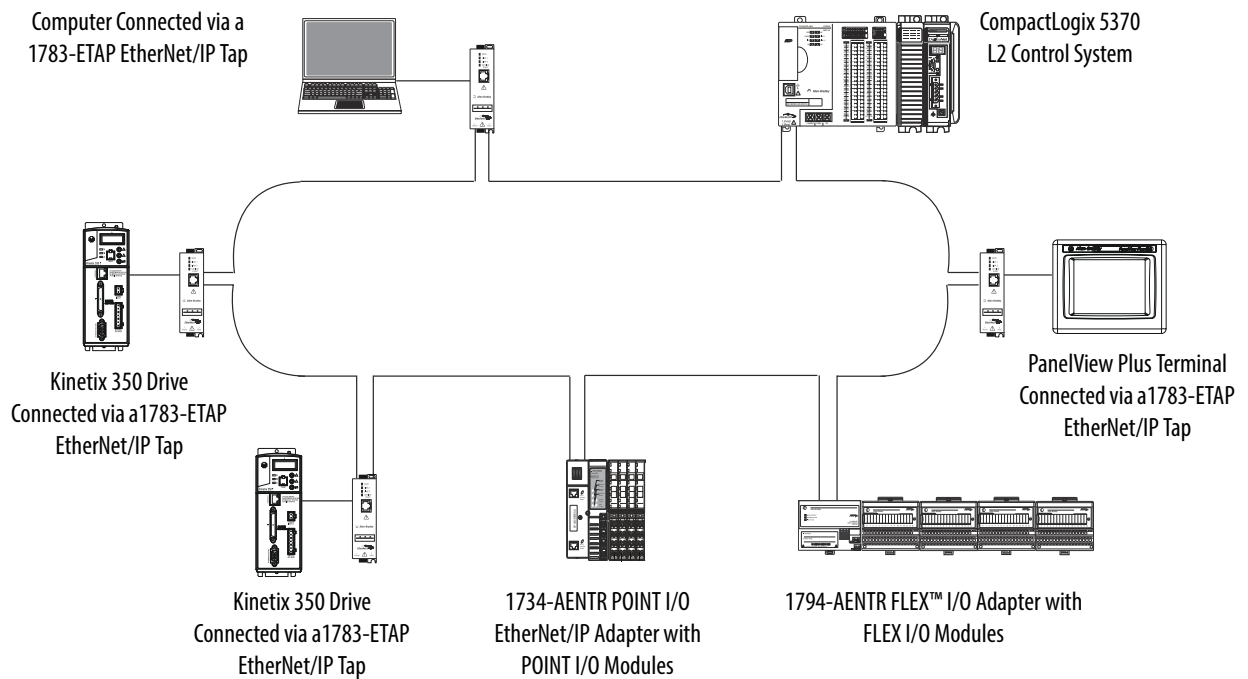

## Follow These Steps

Begin Physical Device Installation

Create an Logix Designer Project

Complete Physical Device Installation

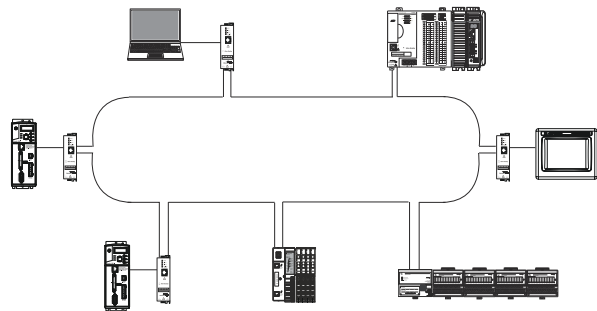
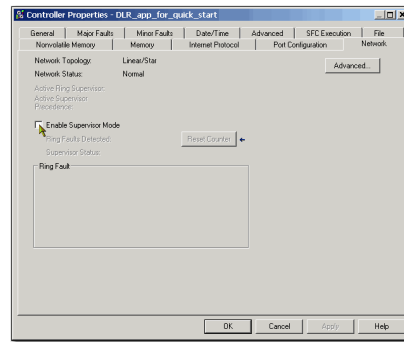
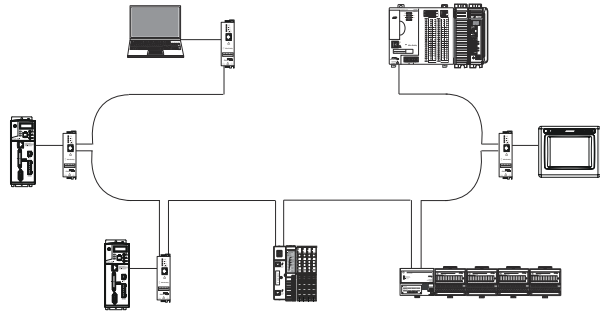

## Integrated Motion on the EtherNet/IP Network

Integrated Motion on the EtherNet/IP network is an integrated motion solution on a standard, unmodified EtherNet/IP network that delivers high performance with lower costs and simpler design or configuration when compared to traditional, multi-network motion applications.

The 1769-L27ERM-QBFC1B controller supports Integrated Motion on an EtherNet/IP network.

### Follow These Steps

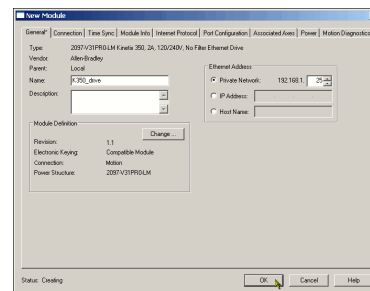
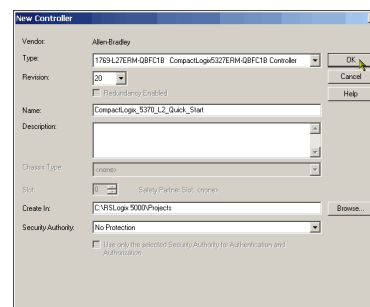
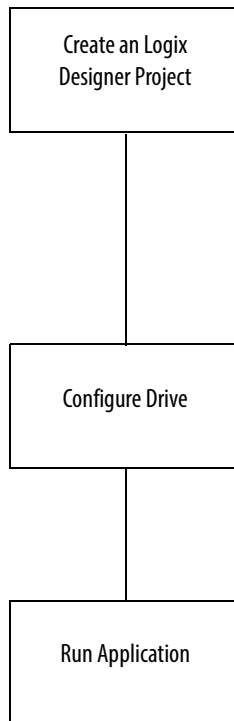

For more information on how to use Integrated Motion on the EtherNet/IP network with a CompactLogix 5370 L2 controller, see the CIP Motion Configuration and Startup User Manual, publication [MOTION-UM003](#).

## Numerics

- 1485A-T1E4 KwikLink terminator/resistor** 15, 17
- 1485C-P1E75 KwikLink cable** 15, 17
- 1485K-P1F5-C KwikLink QD cordset micro right-angle male** 15, 18
- 1485P-P1E4-R5 KwikLink sealed micro connector** 15, 17
- 1485T-P1E4-B KwikLink power tap module** 15, 18
- 1585J-M8PBJM-2 RJ45-to-RJ45 patchcord Ethernet cable** 15, 17
- 1606-XLDNET4 power supply** 15, 17
- 1606-XLDNET8 power supply** 15, 17, 29, 56
- 1769-OB16 output module** 15, 17, 70
  - installation 23
- 1769-SDN scanner module** 10, 15, 17, 71
  - installation 24
  - set node address 57-59
- 1783-EMS08T Stratix switch** 15, 17
- 1784-SD1 card** 20
- 1784-SD2 card** 20

## C

- CompactLogix 5370 L2 controllers**
  - available 10
  - devices to integrate 11
  - features 10
- ControlFLASH software** 14, 32, 36
  - load controller firmware 42-46
- controller firmware**
  - load 42-46

## D

- DeviceNet network** 3, 10, 53-62
  - 1606-XLDNET8 power supply 29
  - connection 29
  - KwikLink QD cordset micro right-angle male 29
  - KwikLink sealed micro connector 29
  - KwikLink sealed terminator 29
  - set node address for 1769-SDN scanner module 57-59
- devices**
  - Kinetix 350 drives 12
  - PanelView Plus terminals 12
  - POINT I/O modules 11
  - PowerFlex 40 drives 12
  - PowerFlex 70 drives 12
  - to integrate in controller application 11
- DLR network topology** 79, 80

## E

- EtherNet/IP network** 3
  - 1783-EMS08T cable 28
  - configure 47-52
  - configure driver in RSLinx Classic software 37
  - connection 28
  - network topologies 10, 80

## F

- features**
  - common to all controllers 10
- firmware**
  - load on controller 42-46

## H

- hardware** 10, 15, 17
  - connections to other devices 4
  - optional system devices 11

## I

- I/O support** 70
- installation**
  - 1769-OB16 output module 23
  - 1769-SDN scanner module 24
  - system 22-25
- Integrated Motion on the EtherNet/IP network** 79, 82
- internal energy storage solution** 10
- IP address**
  - set for computer 39
  - set for the controller 50

## K

- Kinetix 350 drives** 12
- KwikLink cable** 15, 17
- KwikLink power tap module** 15, 18
- KwikLink QD cordset micro right-angle male** 15, 18
- KwikLink QD D cordset micro right-angle male** 29
- KwikLink sealed micro connector** 15, 17
- KwikLink terminator/resistor** 15, 17

## L

- Logix Designer application** 49, 63

**M****motion support**

Integrated Motion on the EtherNet/IP network 79, 82

**N****networks**

configure an EtherNet/IP network 47-52  
connect to a DeviceNet network 29  
connect to an EtherNet/IP network 28  
DeviceNet 3, 53-62  
EtherNet/IP 3  
USB connection 27

**node address**

set in RSNetWorx for DeviceNet software 57-59

**nonvolatile memory**

SD card 10

**P****panel layout**

sample 6

**PanelView Plus terminals** 12**POINT I/O modules** 11**power**

connect to controller 25

**power supply**

1606-XLDNET4 power supply 15, 17  
1606-XLDNET8 power supply 15, 17, 56

**PowerFlex 40 drives** 12**PowerFlex 70 drives** 12**R****required parts** 15**RSLink Classic software** 14, 32, 49

configure EtherNet/IP driver 37

**RSNetWorx for DeviceNet software** 14, 32

create a DeviceNet configuration file 59  
set node address for 1769-SDN scanner module 57-59

**S****SD card** 10, 20

1784-SD1 card 20

1784-SD2 card 20

**software**

ControlFLASH 14, 36

install the Studio 5000 environment 34

Logix Designer application 49, 63

required 14

RSLink Classic 14, 32, 49

RSNetWorx for DeviceNet 14, 32

Studio 5000 14, 32

**Studio 5000 environment** 14, 32

install 34

**U****USB connection** 27, 50





## Rockwell Automation Support

Rockwell Automation provides technical information on the Web to assist you in using its products.

At <http://www.rockwellautomation.com/support/>, you can find technical manuals, a knowledge base of FAQs, technical and application notes, sample code and links to software service packs, and a MySupport feature that you can customize to make the best use of these tools.

For an additional level of technical phone support for installation, configuration, and troubleshooting, we offer TechConnect<sup>SM</sup> support programs. For more information, contact your local distributor or Rockwell Automation representative, or visit <http://www.rockwellautomation.com/support/>.

## Installation Assistance

If you experience a problem within the first 24 hours of installation, review the information that is contained in this manual. You can contact Customer Support for initial help in getting your product up and running.

United States or Canada	1.440.646.3434
Outside United States or Canada	Use the <a href="#">Worldwide Locator</a> at <a href="http://www.rockwellautomation.com/support/americas/phone_en.html">http://www.rockwellautomation.com/support/americas/phone_en.html</a> , or contact your local Rockwell Automation representative.

## New Product Satisfaction Return

Rockwell Automation tests all of its products to ensure that they are fully operational when shipped from the manufacturing facility. However, if your product is not functioning and needs to be returned, follow these procedures.

United States	Contact your distributor. You must provide a Customer Support case number (call the phone number above to obtain one) to your distributor to complete the return process.
Outside United States	Please contact your local Rockwell Automation representative for the return procedure.

## Documentation Feedback

Your comments will help us serve your documentation needs better. If you have any suggestions on how to improve this document, complete this form, publication [RA-DU002](#), available at <http://www.rockwellautomation.com/literature/>.

Rockwell Otomasyon Ticaret A.Ş., Kar Plaza İş Merkezi E Blok Kat:6 34752 İçerenköy, İstanbul, Tel: +90 (216) 5698400

**[www.rockwellautomation.com](http://www.rockwellautomation.com)**

### Power, Control and Information Solutions Headquarters

Americas: Rockwell Automation, 1201 South Second Street, Milwaukee, WI 53204-2496 USA, Tel: (1) 414.382.2000, Fax: (1) 414.382.4444

Europe/Middle East/Africa: Rockwell Automation NV, Pegasus Park, De Kleetlaan 12a, 1831 Diegem, Belgium, Tel: (32) 2 663 0600, Fax: (32) 2 663 0640

Asia Pacific: Rockwell Automation, Level 14, Core F, Cyberport 3, 100 Cyberport Road, Hong Kong, Tel: (852) 2887 4788, Fax: (852) 2508 1846

Publication IASIMP-QS025B-EN-P - December 2012

Supersedes Publication IASIMP-QS025A-EN-P - June 2012

Copyright © 2012 Rockwell Automation, Inc. All rights reserved. Printed in the U.S.A.