

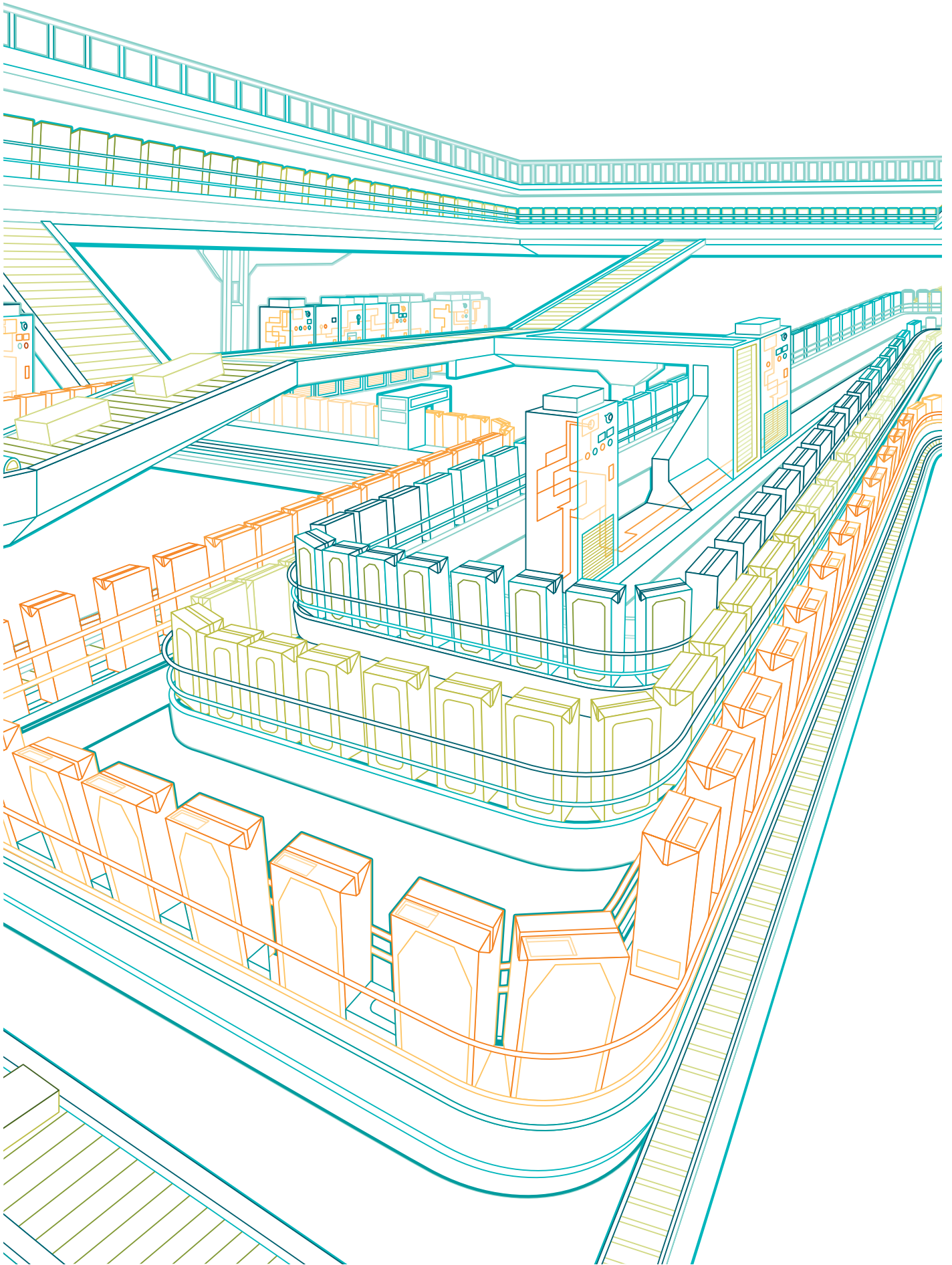

# Drives and controls, motors and mechanical power transmission catalogue 2017



# Drives and controls, motors and mechanical power transmission catalogue

[What's new in 2017](#)

1

[Authorised value providers](#)

2

[Drives and motors packages](#)

3

[Low voltage AC drives](#)

4

[Other drives, accessories and services](#)

5

[AC motors](#)

6

[Motors and generators service and PC tools](#)

7

[Mechanical power transmission](#)

8

[Useful engineering information](#)

9

# What's new in 2017

1

## ABB drives for HVAC, ACH580

The ACH580 replaces the ACH550 and is initially available from 0.75 to 250 kW. The ACH580 brings new levels of ease of use and HVAC functionality, as well as adding safe-torque off connections as standard. New motor control algorithms bring accurate high performance to induction motors, permanent magnet and SynRM motors, allowing the catching of spinning loads and power dip performance. The superior control algorithms are used to control the SynRM motor to achieve specific fan powers without having to resort to

more exotic motor types. The wider power range allows more applications to be tackled, while the new user interface makes it easier to install. Backwards compatibility is maintained with the footprint and the terminal layouts, minimising changes to existing drawings



and making upgrade simple. The ACH580 is a member of the new "all compatible" drive platform, ABB's philosophy of common drives architecture that features the same control panel, harmonised parameters and functions, universal accessories and engineering tools.



## Electrical heating with the DCT880

ABB has adapted the firmware inside its DC drive range to generate a unit for industrial heating applications. The unit is suitable for inductive and resistive loads and for infrared or ultraviolet heaters. Different load configurations such as delta, star, star with neutral and open delta are just a few of the options.

## ABB general purpose medium voltage drive, ACS580MV

The drive is built on ABB's common drives architecture and enables a smooth transition to other drives within the portfolio, such as the ABB general purpose drive, ACS580, or the ABB industrial drives, ACS880. The drive share the same user interfaces, the new assistant control panel, PC tools, options and energy saving calculations, enabling users to use the knowledge gained with the ACS580MV drive, and vice versa. The cabinet-built ACS580MV drive is designed to control pumps and fans in various industries, and is equipped

with standard features that simplify ordering and delivery and reduce cost for installation and commissioning. The drive features a new generation of cascaded h-bridge technology which offers superior mitigation of harmonics in a compact and light design. Other built-in functions like power loss ride-through and automatic restart ensure reliable, trouble-free operation and high robustness against weak network performance. Features like redundant cooling fans and an advanced preventive warning system ensure highest reliability even in harsh industrial environments.



# What's new in 2017



**ABB general purpose drives extend offering**  
The ABB general purpose drive, ACS580, now features the ACS580-04 module for cabinet installation and the ACS580-07 - an ABB built cabinet range. This takes the ABB general purpose drive to 500 kW. The cabinet drive range will be extended

to lower power in late 2017. Being a general purpose drive, the concept is limited to popular options which leads to easier ordering, generating shorter delivery times. For a more tailored solution, ABB offers the ACS880 range, which can be selected and configured as required.



**ABB drive for water and wastewater, ACQ580**  
The ACQ580 is initially available from 0.75 to 250 kW. The drive is IP21 or IP55 and has an extended power range compared to the present offering. The ACQ580 is easy to use and brings new levels of functionality to the water sector, as well as adding safe-torque off (STO) connections as standard (removing the need for contactors). New motor control

algorithms bring accurate high performance control to induction motors, permanent magnet motors and SynRM, as well as the ABB WIMES motor. The ACQ580 is part of ABB's "all compatible" drive platform; a philosophy of common drives architecture that features the same control panel, harmonised parameters and functions, universal accessories and engineering tools.

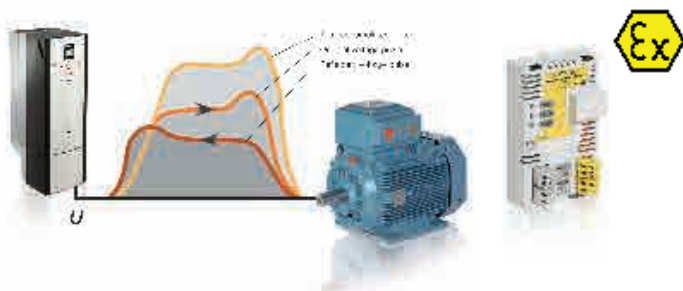

**Enhanced ATEX compliant motor drive packages for hazardous areas**  
As one of the few manufacturers that can offer drives and motors, it has long been possible for ABB to offer compliant motor drive packages under ATEX 2014/34/EU certification. The extensive range of motors on offer for these packages has been increased to include IE3 efficiency rated motors, bringing lower energy

usage to the ATEX arena. The drive package is also enhanced. Having received ATEX approval for the built-in safe-torque off (STO), ABB has added an ATEX certified isolated thermistor relay (FPTC-02) that fits inside the drive. This allows a simple wall mounted drive to protect the motor without the need for external contactors or thermistor relays, so removing the need for a cabinet.

**WIMES-compliant motor**  
A motor specifically designed for water and wastewater applications meets the UK's Water Industry Mechanical and Electrical Specification

(WIMES). The motors are packed with features that offer greater protection against the environmental conditions found in the water and wastewater industry.



# What's new in 2017

1



### Register your ABB drive and protect your investment

You can register your drive using the Drivebase smartphone app. Drivebase allows you to read product manuals and find ABB contact details, sends you service recommendations and enables quick troubleshooting through fault code analysis.



### PROFIsafe enabled drives

With the new Automation Builder engineering tool, ABB's AC500-S safety PLC and the ACS880 drive, it is possible to create an Ethernet-based network topology including standard control and safety control. This network will use PROFIsafe over PROFInet to implement control and safety. Together with the ACS880's FSO safety modules, this means a larger number of safety and control requirements can be met with less wiring.



### ABB drives go wireless – keypads with Bluetooth connectivity

Drivetune is the smart mobile app enabling wireless communication to ABB low voltage drives. The drive needs to have the Bluetooth enabled keypad fitted. You will be able to startup your drive and commission with your phone using simple settings and widgets. The appealing dashboard shows intuitively drive status, performance and configuration.



Unlike traditional control panels, Drivetune makes it possible to connect with any services and data available on the Internet in parallel to online drive communication, providing powerful tools for any start-up and troubleshooting task. In future it will have drive settings that can be easily stored into cloud-based repositories. There are two versions of the Drivetune app, one for Android and the other for iOS operating systems.



### ABB softstarters

ABB's softstarter range are available via the drives business. This means the best possible advice can be given about when to utilise a drive or a softstarter. ABB's soft starter range includes PSTX, PST(B), PSE, PSR, PSS. They cover any motor application from 3 A to 2160 A and are ideal for infrequent starts where a drive is not commercially viable.



### Plug in to SIMATIC environment

ABB offers an add-in to the Siemens SIMATIC PLC PC tool environment. The add-in allows ABB drives to appear on the SIMATIC network and tree structures. ABB drives can now network as effectively as a Siemens drive into existing or new PLC environments and installations, thus preventing the need to take Siemens drives where a

PLC exists. Most of the ABB drives range is supported by this add-in, including the ACS880 and ACS580 drives. The drives can communicate over Profibus or Profinet.



### ABB general purpose drives, ACS480

The ABB general purpose drive range is extended to include a drive with a different hardware form factor. The drive firmware is targeting fan/pump specialists, and will compliment the ABB general purpose drive range, being stocked by ABB's authorised value providers for fast and efficient delivery.

# What's new in 2017



## ABB HES880, a ruggedised water-cooled drive for demanding applications

HES880 is an inverter section for hybrid electric vehicles operating in harsh and demanding areas such as quarries, as well as open deck marine applications, where maximum efficiency, redundancy, weight and size are critical. The drive is rated from 55 to 510 kW, features an IP67 enclosure, and is able to operate from -40 to +85 degrees with

100 percent humidity. Fully enclosed water-cooled technology with its high vibration tolerance (4 g vibrations and 30 g shocks), the HES880 offers rugged, reliable performance. It can be used in inverter mode to control the torque and speed of a traction motor. When used in its generator mode, it can control the DC-link voltage in an electrical drivetrain. The DC/DC mode enables use with a battery or super capacitor.



## New washdown motor meets exacting hygiene standards

ABB has launched its IEC stainless steel washdown motor for the strict hygiene standards demanded by the food and beverage industry. The stainless steel casing, rated to IP69K, means the motor can resist direct water sprays at 100 bar and 80 degrees centigrade, allowing food production equipment to be cleaned in place. The motor's resistance to corrosion and ability to withstand harsh conditions enhances the reliability of the production time, ensuring maximum uptime.

The smoothly finished surface features laser engraved markings and a self-draining design, discouraging the growth of micro-organisms. The bearings are lubricated with H1 food grade grease, ensuring safe operation in food processing environments. Encapsulated windings ensure the motor has a long life in extremely humid conditions. Cooling is based on the totally enclosed, not ventilated (TENV) method, using only natural ventilation and radiation from the totally enclosed surface, allowing easy cleaning and preventing the ingress of water. Supplied in either 50 Hz or 60 Hz variants, 230 to 690V, the motors are rated from 0.37 to 7.5 kW and with 2 to 6 poles. B14, B5 and B3 mountings make it suitable for a wide range of applications.



## Matched servo motor-drive package provides high performance and IoT connectivity

A compact, highly dynamic motion control package, comprising ABB's new MicroFlex e190 servo drive and e-series servo motor, ensures optimised machine designs for a variety of motion applications. The drive's Ethernet capability enables easy connection to the Internet of Things, while

improved installation, commissioning, operating and maintenance features contribute to a lower total cost of ownership. EtherCAT® and Powerlink real-time protocols, along with EtherNet/IP™, Modbus TCP and Profinet® I/O are all built-in and selectable by software and combine with universal feedback support provide a highly flexible compact package.

## Condition monitoring solution for LV motors

ABB's smart sensor picks up data on vibration, temperature and other parameters and uses it to reduce motor downtime, extend lifetime and lower energy use. (see page 111)



## In-situ visual inspections for motors and generators

ABB offers visual inspection services for motors and generators with the rotor in-situ. A super-slim robotic inspection crawler - ABB Air Gap Inspector - moves in the air gap between the rotor and stator, covering the entire length of the core. It provides a video feed of the stator and rotor inner surfaces, windings, wedges, stator teeth, air ducts, rotor support blocks and parts of the end windings.

# Authorised value providers



2

Authorised value providers deliver sales, support, service and engineering expertise in seamless cooperation with ABB. Being strategically located throughout the UK and Ireland, they bring ABB's products and services directly to your site along with the same technical knowledge and back-up,

combined with the best equipped repair and maintenance facilities in Europe. All providers undertake extensive and on-going training in all aspects of motors, drives and services. This provides the consistency of support, wherever in the UK and Ireland you are located.

## Authorised value providers - Drives

Offer one of the largest stocks of AC drives, from 0.18 kW to 500 kW, available off-the-shelf.

1. ACS Drives & Control Systems  
Ireland  
Tel: +353 (0)44 934 0242
2. Advantage Control  
Northern Ireland  
Tel: 028 4461 3782
3. APDS  
South West  
Tel: 0117 982 2049
4. Central Group  
Merseyside  
Tel: 0151 546 6000
5. EDC (Scotland)  
Scotland  
Tel: 0141 812 3222
6. Gibbons Engineering Group  
East Anglia  
Tel: 01621 868 138
7. Halcyon Drives  
Yorkshire and Greater Manchester  
Tel: 0113 236 1509
8. iDrives  
South  
Tel: 01483 766 555
9. Inverter Drive Systems  
East Midlands  
Tel: 0115 944 1036
10. MKE Engineering Group  
South East  
Tel: 01795 438 436
11. Quantum Controls  
North East  
Tel: 01661 835 566
12. Sentrledge Control  
Midlands  
Tel: 024 7655 3303



## Authorised value providers - Motors

Offer electric motors up to 1,000 kW.

1. AAR Powerdrives  
West Midlands  
Tel: 0138 440 0800
2. APDS  
South West  
Tel: 0117 982 2049
3. Beta Power Engineering  
Cheshire  
Tel: 0161 432 9995
4. Campbell Electric Motors  
Ireland  
Tel: +353(0) 1 4628 333
5. Central Group  
Merseyside  
Tel: 0151 546 6000
6. CovElec (Leics)  
Leicestershire  
Tel: 0116 269 8111
7. EDC (Scotland)  
Scotland  
Tel: 0141 812 3222
8. EMR Silverthorn  
Middlesex  
Tel: 020 8903 1390
9. H.G. Rewinds  
Staffordshire  
Tel: 01782 262525
10. Halcyon  
West Yorkshire  
Tel: 0113 236 1509
11. Heasell Electromechanical Services  
Hertfordshire  
Tel: 01763 243369
12. JJ Loughran  
Northern Ireland  
Tel: 028 8676 2295
13. MKE Engineering Group  
Kent  
Tel: 01795 438 436
14. Quantum Controls  
North East  
Tel: 01661 835 566

Call authorised value providers on:  
**07000 ABB AVP (07000 222 287)**

Search "AVP energy toolkit"





# Authorised value providers

## Life cycle services

Proactive drives and motors maintenance programmes keep you competitive by minimising disruption to your production.

The many drives and motors used in industry have a high degree of reliance placed upon them and often perform critical duties and have a high in-service value. A failure of either asset can result in loss of production and revenues, as well as having safety and environmental consequences. To reduce the risk and consequences of failure, the drive and motor must be properly maintained at the right times in their life cycle.

### Life cycle services

The services offered by the authorised value providers span the entire value chain, from the moment a customer makes the first enquiry to disposal and recycling of either the motor or the drive. Throughout the value chain, the providers offer training, technical support and customised contracts.

### Pre-purchase

The authorised value providers offer a range of services that help guide the customers to the right products for their applications.

### Order and delivery

Orders can be placed directly with the authorised value providers, for timely deliveries including express delivery.



### Installation and commissioning

While many customers have the resource to undertake installation and commissioning on their own, the authorised value providers offer professional installation and start-up services.

### Operation and maintenance

From site surveys to preventive maintenance and reconditioning of drives and motors, ABB has all the options covered to keep its customers' processes operational.

### Upgrade and retrofit

An existing ABB drive or motor can often be upgraded to the latest model to improve the performance of the application.

### Replacement and recycling

Authorised value providers can advise on the best replacement drive or motor while ensuring that the existing assets are disposed of in a way that meets all local environmental regulations. ISO14001 certificates can also be provided.

### Entire value chain services

The main services available throughout the entire value chain include:

- Training
- Technical support
- Contracts





# Drives and motors packages

<a href="#">Introduction</a>	<a href="#">12</a>
<a href="#">Standard motor and VSD package</a>	<a href="#">14</a>
<a href="#">Synchronous reluctance motor-drive package</a>	<a href="#">16</a>
<a href="#">ATEX compliant</a>	<a href="#">18</a>
<a href="#">Deck winch</a>	<a href="#">22</a>
<a href="#">Cranes and hoists</a>	<a href="#">23</a>
<a href="#">Aggregates</a>	<a href="#">24</a>
<a href="#">Cooling tower direct drive-motor</a>	<a href="#">25</a>

# Drives and motors packages

## Introduction

3

ABB is one of the only companies that makes both variable speed drives and low voltage AC motors. As such it is well equipped to offer customers a perfectly designed, tested and approved matched pair, for whatever the motor-driven application.

In addition, ABB has devised a selection of bespoke drives and motors packages aimed at specific industry applications.

ABB has also developed special firmware versions that support the hardware packages. Pre-developed firmware for winches, cranes (including anti-sway), winders, spinning machines and others exist already, reducing development time when designing a complex system.

Packages can extend beyond matching a motor and a drive. Other components, many of which are featured in this catalogue, also form part of the drive train – from bearings, couplings and gearboxes to programmable logic controllers (PLCs), switches and fusegear.



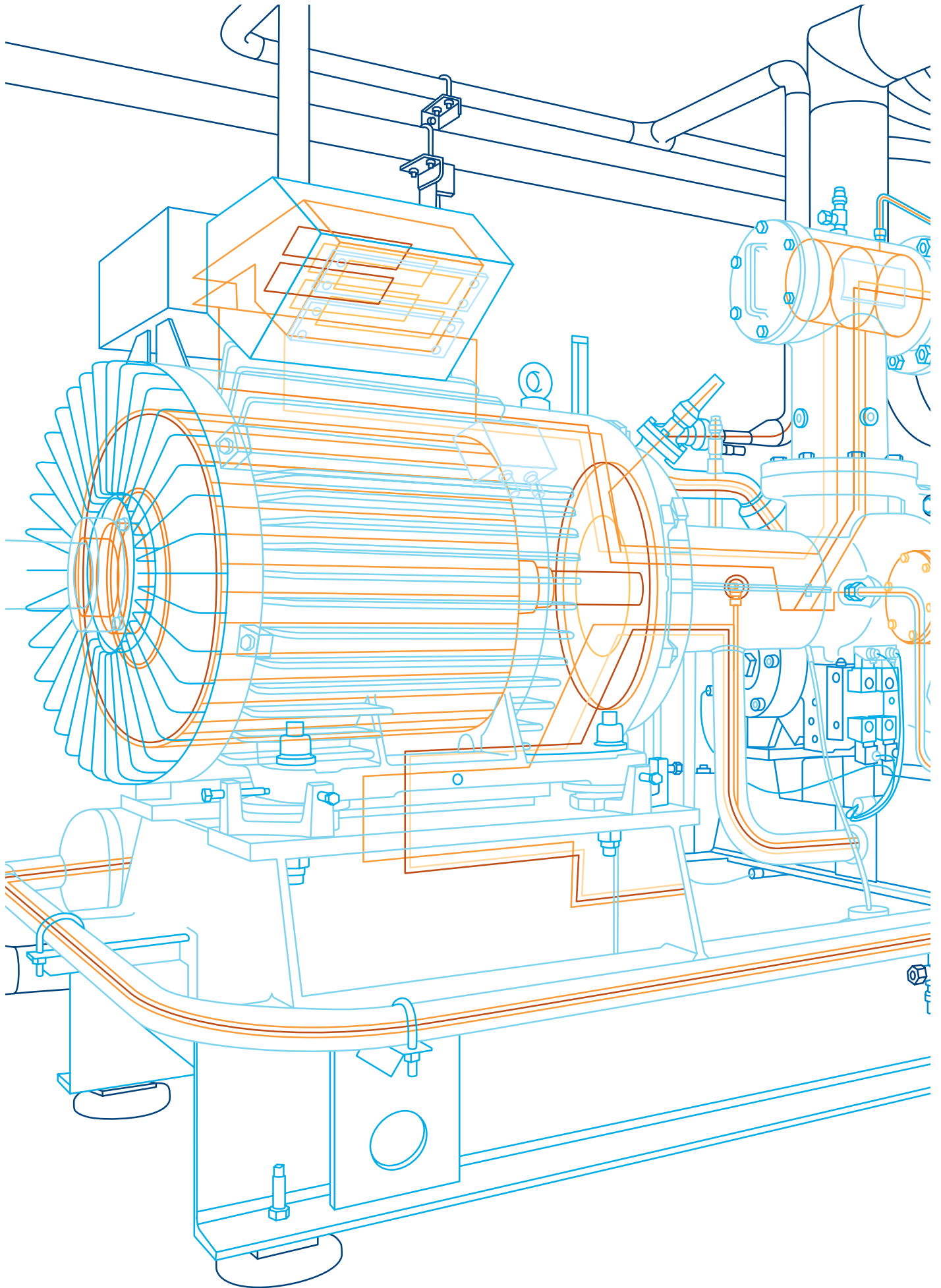

# Drives and motors packages

## Standard motor and VSD package

From 1st January 2017, motors from 0.75 kW to 375 kW, must meet either the IE3 efficiency level (driven direct online) or the IE2 level if fitted with a variable speed drive (VSD), in order to comply with the European Minimum Energy Performance Standard (EU MEPS).

3

ABB offers a wide range of VSDs, all of which can be fitted to IE2 motors to deliver efficient, reliable and compliant motor control, satisfying regulations.

ABB offers packages for IE3 and IE4 induction motors. The motors are suitable for harsh environments, marine, crane and ATEX applications, as well as many others.

### ABB machinery drive ACS355

- 0.37 kW to 22 kW
- FlashDrop - parameter programming with drive still in its box
- Sequence programming designed for food and beverage and materials handling applications
- ACS880-M04 and ACS380 machinery drives also available



See details on page 35

### ABB general purpose drives ACS310

- 0.37 kW to 22 kW
- Pump and soft pump and fan control (PFC and SPFC)
- Pipe cleaning (anti-jam) and pipe fill functions



See details on page 39

### ABB drive for HVAC ACH580

- 0.75 kW to 250 kW
- Dedicated to HVAC
- Rapid start-up, trouble-free use, easy interfacing
- Built-in BACnet



See details on page 47

### ABB industrial drive ACS880

- Intuitive control panel and PC tool
- Direct torque control (DTC) for precise open- and closed-loop control
- Built-in safety features for simplified configuration
- Communication with all major automation networks



See details on page 43

### ACS580

- 0.55 kW to 500 kW
- Wide power range in wall-mounted IP21 and IP55 variants
- Sensorless vector and scalar control

- Removable memory unit for easy drive commissioning and replacement
- Energy optimiser and energy efficiency information for monitoring and saving energy



See details on page 56

General performance motors combine convenience and easy handling seamlessly with ABB's engineering expertise, while providing standard variants and modifications. The motors can be tailored according to the specific needs of end-users and OEMs.

#### Highlights

- 0.06 kW to 355 kW
- One year warranty
- IE2 & IE3
- 2, 4 & 6 pole designs

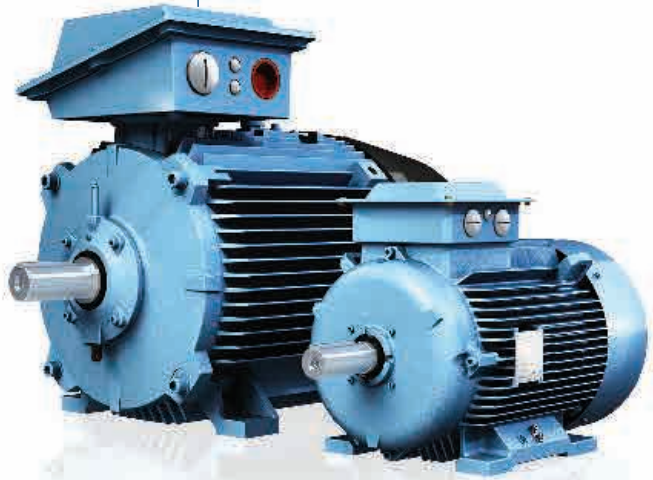

Process performance motors are the flagship of ABB's standard low voltage motors. This range provides the most comprehensive, versatile set of motors for the process industries and heavy-duty applications which are dependent on continuous reliability, lowest possible environmental impact and life cycle costs.

#### Highlights

- 0.09 kW to 1,000 kW
- Three years warranty and an option to extend to five years
- IE2, IE3 & IE4
- All variant codes available for process industry applications



# Drives and motors packages

## Synchronous reluctance motor-drive package

Get the best of both worlds. The efficiency advantages of permanent magnet technology together with the simplicity and service-friendliness of an induction motor platform. Each motor-drive package combines proven stator technology and innovative magnet-free rotor design motor, a best-in-class drive and advanced software to offer a complete, optimised solution.

3

The table below shows a quick selection for 1500 rpm motors (ABB can perform an optimised selection if required). Although all of SynRMs motors are 4-pole, the VSD handles the control for the differing speeds. SynRM are installed into a wide range of applications, from paper machines to crushers, offering improved control, maintainability and robustness.

Motor kW	High Output SynRM 1500rpm	ACH580	ACS580	ACQ580	ACS880
1.1	M3AL 90 LA 4	ACH580-01-03A3-4	ACS580-01-03A3-4	ACQ580-01-03A3-4	ACS880-01-03A3-3
1.5	M3AL 90 LB 4	ACH580-01-04A0-4	ACS580-01-04A0-4	ACQ580-01-04A0-4	ACS880-01-04A0-3
2.2	M3AL 90 LD	ACH580-01-07A2-4	ACS580-01-07A2-4	ACQ580-01-07A2-4	ACS880-01-07A2-3
3	M3AL 100 LB 4	ACH580-01-07A2-4	ACS580-01-07A2-4	ACQ580-01-07A2-4	ACS880-01-07A2-3
4	M3AL 100 LD	ACH580-01-12A6-4	ACS580-01-12A6-4	ACQ580-01-12A6-4	ACS880-01-12A6-3
Motor kW	IE4 SynRM 1500rpm	ACH580	ACS580	ACQ580	ACS880
5.5	M3AL 132 SMA 4	ACH580-01-12A6-4	ACS580-01-12A6-4	ACQ580-01-12A6-4	ACS880-01-12A6-3
7.5	M3AL 132 SMB 4	ACH580-01-017A-4	ACS580-01-017A-4	ACQ580-01-017A-4	ACS880-01-017A-3
11	M3AL 132 SMC 4	ACH580-01-025A-4	ACS580-01-025A-4	ACQ580-01-025A-4	ACS880-01-025A-3
11	M3BL 160 MLA 4	ACH580-01-025A-4	ACS580-01-025A-3	ACQ580-01-025A-4	ACS880-01-025A-3
15	M3BL 160 MLB 4	ACH580-01-038A-4	ACS580-01-038A-3	ACQ580-01-038A-4	ACS880-01-035A-3
18.5	M3BL 180 MLA 4	ACH580-01-045A-4	ACS580-01-045A-3	ACQ580-01-045A-4	ACS880-01-043A-3
22	M3BL 200 MLF 4	ACH580-01-062A-4	ACS580-01-061A-3	ACQ580-01-062A-4	ACS880-01-050A-3
30	M3BL 200 MLA 4	ACH580-01-073A-4	ACS580-01-073A-4	ACQ580-01-073A-4	ACS880-01-069A-3
37	M3BL 250 SMF 4	ACH580-01-088A-4	ACS580-01-088A-4	ACQ580-01-088A-4	ACS880-01-085A-3
45	M3BL 250 SMG 4	ACH580-01-106A-4	ACS580-01-106A-4	ACQ580-01-106A-4	ACS880-01-103A-3
55	M3BL 250 SMA 4	ACH580-01-145A-4	ACS580-01-145A-3	ACQ580-01-145A-4	ACS880-01-123A-3
75	M3BL 280 SMA 4	ACH580-01-206A-4	ACS580-01-206A-3	ACQ580-01-206A-4	ACS880-01-173A-3
90	M3BL 280 SMB 4	ACH580-01-206A-4	ACS580-01-206A-3	ACQ580-01-206A-4	ACS880-01-202A-3
110	M3BL 280 SMC 4	ACH580-01-246A-4	ACS580-01-246A-3	ACQ580-01-246A-4	ACS880-01-245A-3
110	M3BL 315 SMA 4	ACH580-01-246A-4	ACS580-01-246A-3	ACQ580-01-246A-4	ACS880-01-245A-3
132	M3BL 315 SMB 4	ACH580-01-293A-4	ACS580-01-293A-3	ACQ580-01-293A-4	ACS880-01-290A-3
160	M3BL 315 SMC 4	ACH580-01-363A-4	ACS580-01-363A-3	ACQ580-01-363A-4	ACS880-01-343A-3
200	M3BL 315 MLA 4	ACH580-01-430A-4	ACS580-01-430A-3	ACQ580-01-430A-4	ACS880-01-427A-3
250	M3BL 315 LKA 4	n/a	ACS580-04-585A-3	n/a	ACS880-04-585A-3
315	M3BL 315 LKC 4	n/a	ACS580-04-650A-3	n/a	ACS880-04-650A-3

### ACH580

- 0.75 kW to 250 kW
- Dedicated to HVAC
- Rapid start-up, trouble-free use, easy interfacing
- Built-in BACnet



See details on page 47

### ACS580

- 0.55 kW to 500 kW
- Wide power range in wall-mounted IP21 and IP55 variants
- Sensorless vector and scalar control



See details on page 43

### ACQ580

- 0.55 kW to 250 kW
- Dedicated drive for water and wastewater applications



See details on page 51

### ACS880

- 0.55 kW to 3200 kW
- Direct torque control (DTC) for precise open- and closed-loop control
- Built-in safety features



See details on page 56



### IE4 SynRM

The IE4 design offers super premium efficiency motors in a chassis that is identical to standard IEC induction motor frame sizes and fixings, offering a direct replacement package with a better efficiency. The variable speed drive (VSD) + IE4 SynRM motor package has a better efficiency than a VSD + IE4 induction motor package.

- Aluminium frame 132
  - 5.5 kW to 15 kW
- Cast iron frame 160 to 315
  - 7.5 kW to 315 kW
- 40 percent lower losses compared to induction designs
- No magnets
- Cool running rotor
- Improved bearing system reliability
- Easy to service
- Simple to retrofit on induction motor applications due to identical physical size



### High Output (HO) SynRM

High Output (HO) design takes advantage of the 40 percent fewer losses, allowing ABB to offer SynRM in a motor frame that can be two frames smaller than a conventional induction motor, while providing more power in a smaller package. SynRM weighs less than the equivalent induction motor, so applications where space and weight are premium are ideal for the HO design.

- Aluminium frame 90 to 132
  - 1.1 kW to 37 kW
- Cast iron frame 160 to 315
  - 17 kW to 350 kW
- Achieve the same output with a motor that's up to two frame sizes smaller
- Enables smaller, lighter and more cost-efficient machine designs
- Ideal for applications where space and weight factors are critical

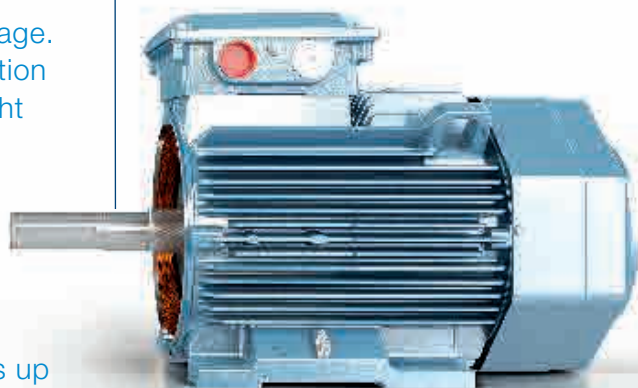

# Drives and motors packages

## ATEX compliant

An ATEX approved AC motor and drive combination gives safe, economical power combined with effective control. By choosing an ATEX compliant motor-drive package, end-users can be confident that it is optimised for their application, complies to ATEX 2014/34/EU and is commercially beneficial, giving more available power for your money.

3

### ABB industrial drive, ACS880

- ATEX approved STO, no need for contactor
- ATEX certified PTC relay fits inside
- FPTC-02 ATEX certified option module



- Direct torque control (DTC) proven motor control platform
- All major types of drive topology covered - 6-pulse, 12-pulse, 4-quadrant, low harmonic, air-cooled and water-cooled
- Built-in safety module



See details on page 56

### ABB general purpose drive, ACS550

- 0.37 kW to 355 kW
- Assistant control panel providing intuitive use of the drive
- Patented swinging choke for superior harmonic reduction
- Sensorless vector and scalar control



#### \*ACS580

- 0.55 kW to 500 kW
- Superior keypad
- IP21, IP55
- Patented swinging choke
- Sensorless vector
- STO as standard
- CPTC ATEX certified option modules



\*Check with ABB regarding ATEX availability.

See details on page 43



### ABB machinery drive, ACS355

- IP20 as standard (UL type 1 as option)
- IP66/69 variants
- Advanced functionality with sequence programming
- Configuration of unpowered drive in two seconds
- Compact installation
- STO as standard



See details on page 35

ABB hazardous area low voltage motors

- Flameproof motors, frame size 80 to 450
- 0.18 kW to 710 kW
- Non-sparking motors, frame size 71 to 450
- 0.09 kW to 1,000 kW
- Loadability curves optimised for ABB drives



ABB Ex tD/DIP motors

- Ex tD/DIP motors, frame size 71 to 450
- 0.09 kW to 1,000 kW
- IP55 or IP65 for non-conductive dust
- IP65 for conductive dust
- Loadability curves optimised for ABB drives

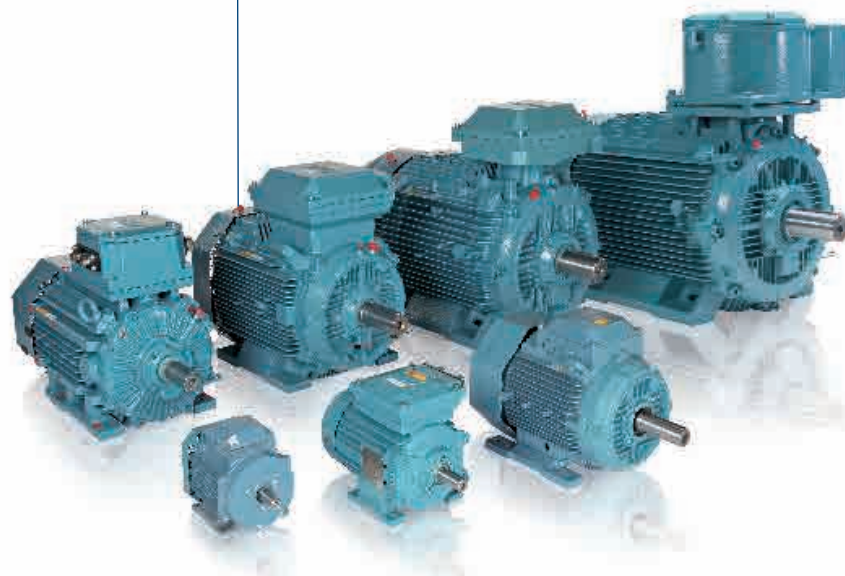

# Drives and motors packages

## ATEX compliant

The route to EC Declaration of Conformity for ABB low voltage AC drives and motors (ATEX 2014/34/EU)

**Important note:** This flowchart only applies to standard ABB motors  
 Type testing means thermistor relays are not mandatory but to allow protection against stall conditions they are recommended for a safe installation. Use ATEX approved thermistor measurement.  
 ACS880/ACS580 do not require a contactor as the ATEX approved STO can be used to disconnect.  
 ACS880/ACS580 do not require an external PTC relay, as an internal option can be used.

3





ABB drive, without DTC



Additional testing required to obtain EC Declaration of Conformity

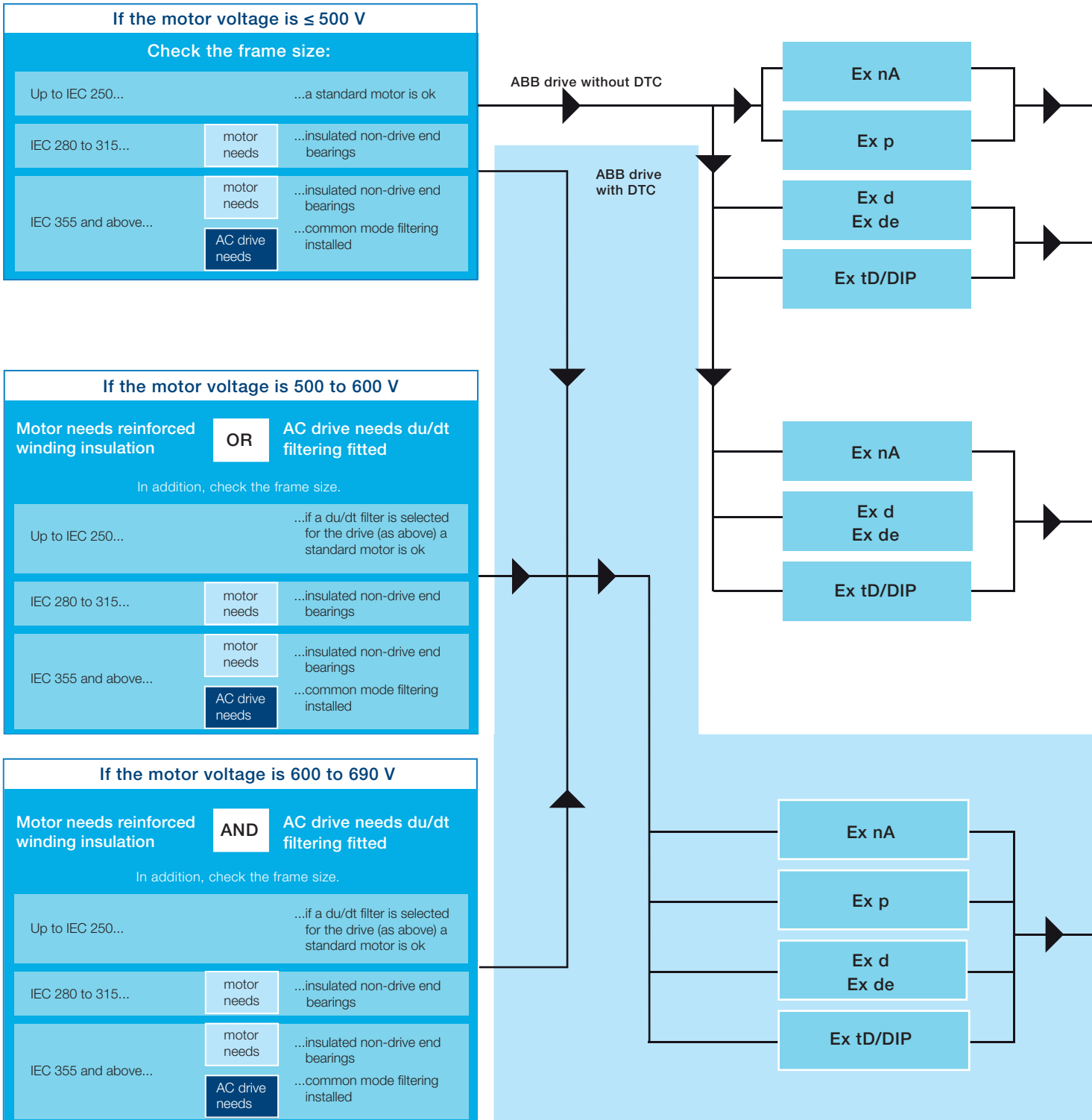

ABB machinery drive, ACS355

Please check motor load capacity curves to ensure correct dimensioning of the motor

Motor to be equipped with thermal control to ensure Ex-temperature class

EC Declaration of Conformity



ABB general purpose drive, ACS550

ABB general purpose drive, ACS580

\*Check with ABB regarding ATEX availability

Please check motor load capacity curves to ensure correct dimensioning of the motor

EC Declaration of Conformity

ABB industrial drive, ACS880 with DTC



Combine ATEX approved STO with FPTC-02 to form a compliant installation that can be installed onto a wall. No contactor, no external relays

**DriveSize**

Using this tool, users can select a suitable combination of motor and drive. The tool also shows combinations that have not been tested.

**Website**

Contains all relevant certificates for tested drive and motor combinations. [www.abb.com/drives](http://www.abb.com/drives) [www.abb.com/motors&generators](http://www.abb.com/motors&generators)

EC Declaration of Conformity

# Drives and motors packages

## Deck winch

ABB offers motors and drives for anchoring and mooring winches, RoRo gate ramp winches and tugboat winches. A deck winch motor-drive package consists of an ABB low voltage marine motor with mechanical disc brakes and an ABB industrial drive, ACS880. Both are designed to stand up to the operations and installations found on many sea-going vessels. SynRMs have now been successfully used on many winch systems.

ABB's marine certified motors and drives fulfil marine and offshore requirements and the design and operation comply with regulations from all major classification societies. ABB's electrical drive solutions improve reliability and offer advantages over hydraulic systems. They enable more precise rope control and reduce operating noise. No hydraulics means no hydraulic fluid concerns, fewer parts, reduced installation space and lower maintenance needs.

### Control stand integration

- Connect up to three control stands and one wireless radio controller to a single drive
- Connect via drive I/O, PLC or fieldbus communications

### ABB industrial drive, ACS880

- Built-in winch control program
- The combination of direct torque control (DTC) and winch control program eliminate the need for motor shaft encoders and load cell sensors in the winch gearbox
- Ensures smooth winch start-up, eliminating the motor start-up voltage and current peaks on the ship's electrical network
- SynRM control as standard
- Dynamic braking with integrated brake chopper and external braking resistor
- Stepless speed and torque operation reduces winch noise
- Direct bulkhead installation or in cabinets (marine certified)

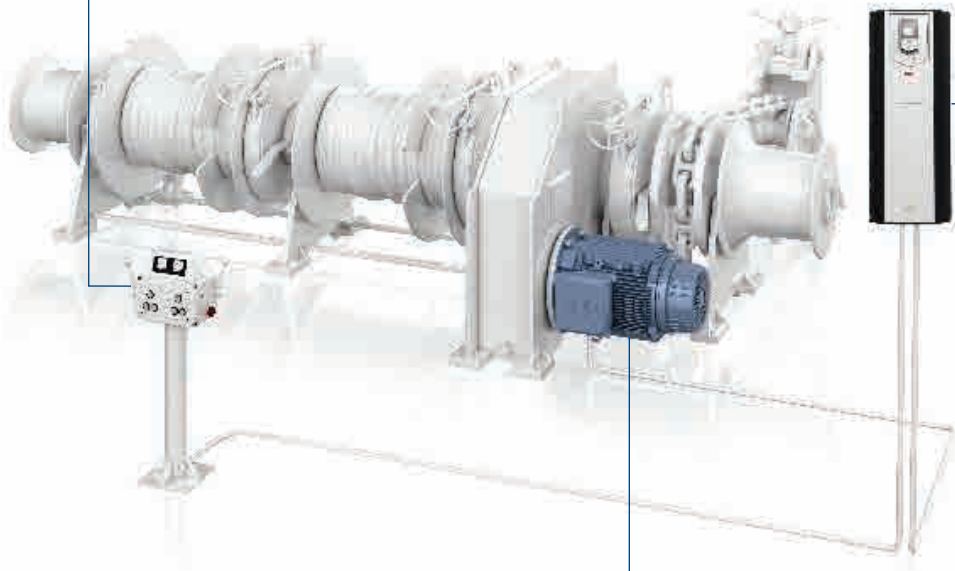

### Low voltage marine motors with mechanical disc brakes

- Exact nominal data on rating plate helps optimise motor operation especially when motor encoder is not used
- Specially designed low wear shaft seals
- SynRM available

- Corrosion resistance improved with zinc primer painting
- IP56 open deck protection class
- Optional heating element and temperature supervision
- Ex motors available

# Drives and motors packages

## Cranes and hoists

ABB has been generating crane-specific software for over 20 years such that today virtually any crane type can be controlled. The SynRM brings more accurate control, with 0.01 percent speed accuracy in open-loop. It has 40 percent fewer losses compared to induction motors, while the high output version can be two frames smaller. The crane software operates with the ABB industrial drive, ACS880, which provides premium motor control, including torque at zero speed, through the use of direct torque control (DTC).



### Highlights

- Sensorless anti-sway control
- Mechanical brake control
- Master-follower operations, ideal for long travel operations
- Synchro control, synchronises the operation of main hooks
- Direct torque control (DTC) ABB's signature motor control algorithm
- Safe torque off (STO) as standard
- Built-in additional drive based programmable safety to SIL 3 / PL e
- Safety PLCs incorporating ProfiSafe, to allow direct communications to the built-in safety module
- Control via I/O of fieldbuses
- Custom crane solutions via a PLC library for larger crane systems

To see the accuracy of the ABB crane systems – take the challenge at: <http://new.abb.com/drives/acs880-challenge/>



Built-in functional safety

# Drives and motors packages Aggregates

3

ABB has a long history of controlling machinery in the aggregates industry, including powering the world's largest mobile mineral crusher, which operates in an open cast mine in Australia. Several different drives can be used to optimise every part of an aggregates plant. The ABB industrial drive, ASC880, for instance, has an extensive power range and topologies to suite every kind of application. Featuring the world renowned direct torque control (DTC) motor control platform, the robust and reliable ACS880 handles high torque loads and transients. The ABB general purpose drive can be used for less demanding machines, fans and pumps. The ABB machinery drive is ideal where precision is needed, for example, to pack or palletise materials. ABB's drive technology is complimented by a range of motors which boast the best in robust design and performance, especially suited to the aggregates industry. ABB can also integrate the entire operation with its PLC and HMI range, incorporating control with the TÜV certified safety systems built into the drives.

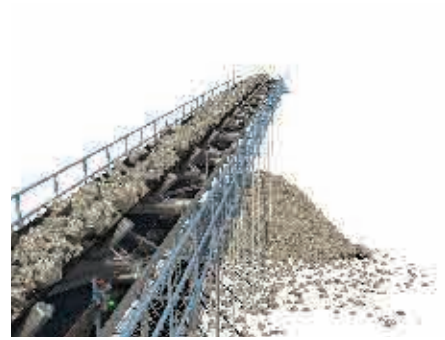

## ABB drives highlights

- Wide range of powers to suite specific aggregate applications
- Liquid-cooled designs to minimise ingress of dust
- IP55 variants where required, or flange mounting for easy heat and dust management
- Supreme motor control, especially good at high torque loads
- All-compatible user interfaces, so all drive families operate the same with the same tools
- Designed to work optimally with ABB motors
- SynRM control as standard
- PLC's and HMI range to integrate controls and safety across the operation

## ABB motors highlights

- Reinforced insulation
- Standard and enhanced dust seals
- Bearing monitoring
- Enhanced IP classes
- Improved paint systems





# Drives and motors packages

## Cooling tower direct drive-motor

The ABB motor-drive package for cooling towers comprises an ABB permanent magnet motor with an ABB industrial drive, ACS880. Together, the package delivers precise fan control without the need for a gearbox, even under low load or speed conditions often experienced in cooling tower applications. ABB's RPM AC permanent magnet motor has a high power and torque density ratio which is needed to achieve the sustained low speed required for cooling tower operation. It is designed to retrofit into existing gearbox footprints within the cooling tower to allow swap-out in less than six hours.

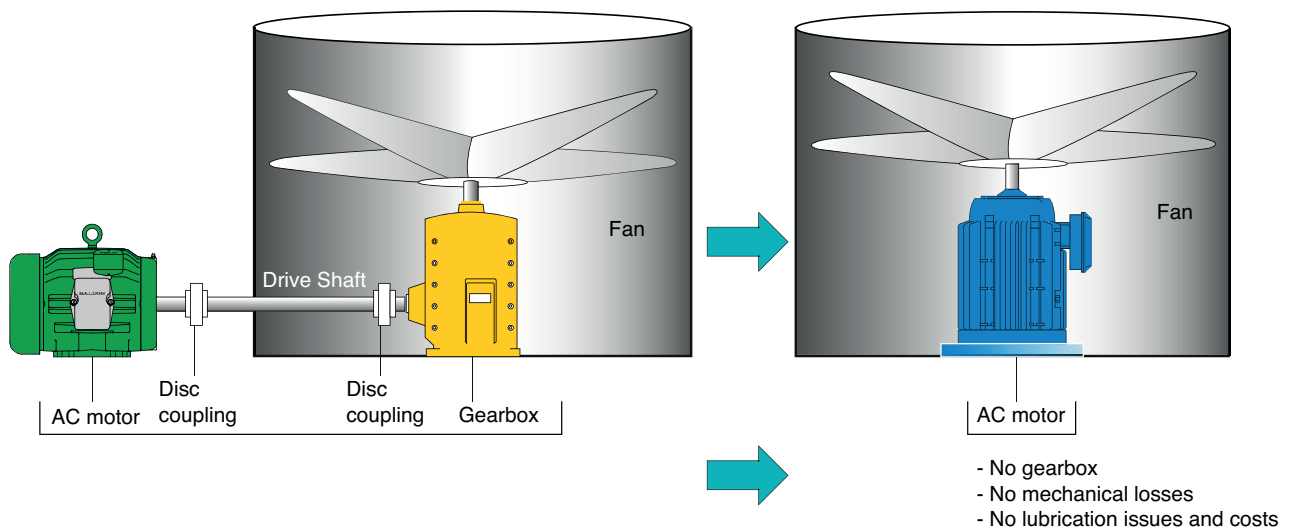

- ABB industrial drive, ACS880 and RPM AC permanent magnet motor
- Designed to drop directly into existing gearbox mounting patterns
  - Retrofit can be accomplished in under six hours
  - Eliminates gearbox, lowers vibration and system noise
  - Permanent magnet control greatly increases operating efficiencies even under lightly loaded conditions, typical in fan applications at low speeds
  - Temperature rise in the motor is considerably lower
  - A power dense package increases motor life compared to a conventional induction motor system
  - Special weather sealing ensures maximum life expectancy





# Low voltage AC drives

<a href="#">Drives feature finder</a>	28
<a href="#">ABB micro drives</a>	30
<a href="#">ABB machinery drives</a>	35
<a href="#">ABB general purpose drives for fans and pumps</a>	39
<a href="#">ABB general purpose drives</a>	43
<a href="#">ABB drives for HVAC</a>	47
<a href="#">ABB drives for water and wastewater</a>	51
<a href="#">ABB industrial drives</a>	56
<a href="#">ABB industrial drive variants</a>	67

# Drives feature finder

The table highlights the differences between the various ABB drives families. It also lists some of the key features of the different ABB drives. However, the table is not exhaustive and if you are seeking a feature which does not appear in the table, please contact ABB for information.



Drive range		ABB micro drives (ACS55 - p30) (ACS150 - p32)	ABB machinery drives (ACS355 - p35)	ABB general purpose drives for fans and pumps (ACS310 - p39)
<b>Voltage &amp; power</b>	<b>Details or additional notes</b>	(ACS55) 1-ph 100 - 120 V: 0.18 - 0.37 kW 1-ph 200 - 240 V: 0.18 - 2.2 kW (ACS150) 3ph 380 - 480 V, 0.37 - 4.0 kW	1-ph 200 - 240 V: 0.37 - 2.2 kW 3-ph 200 - 240 V: 0.37 - 11 kW 3-ph 380 - 480 V: 0.37 - 22 kW	1-ph 200 - 240 V: 0.37 - 2.2 kW 3-ph 200 - 240 V: 0.37 - 11 kW 3-ph 380 - 480 V: 0.37 - 22 kW
<b>Other rectifier options (assume 6-pulse as standard)</b>	12-pulse diode Low harmonics regenerative (4Q) Low harmonics non-regenerative (2Q) Common DC link connectability	- - - -	- - - -	- - - -
<b>EMC compliance (EN 61800-3, 2004)</b>	No EMC filter 2nd unrestricted (C3) 1st restricted (C2) 1st unrestricted (C1)	● (or remove EMC screw) ● ■ (ACS150) ● - (ACS150)	● (remove EMC screw) ● ■ -	● (remove EMC screw) ● ■ -
<b>Harmonic filter / choke / active (EN 61000-3-4)</b>	Choke (AC or DC) Swinging choke (better harmonic performance) Low harmonic (best performance)	■ - -	■ - -	■ - -
<b>Enclosure class</b>	IP00 IP20 IP21 (or near equivalent) IP22 IP42 IP54/ IP54R/ IP55 IP66/69K	- ● ○ (Nema 1, ACS150) - - - -	- ● ○ (Nema 1) - - - -	- ● ○ (Nema 1) - - - -
<b>Mechanical construction</b>	Module - panel mountable (IP20 minimum) Wall-mounted (IP21 or equiv. minimum) Free-standing, floor-standing Cabinet built by ABB	●* (DIN mount + screw) ○ (Nema 1, ACS150) - -	●* (DIN mount + screw) ○ (Nema 1 kit) - -	●* (DIN mount + screw) ○ (Nema 1 kit) - -
<b>Cooling method</b>	Direct air-cooling Water-cooling Through panel/flange mount	● - -	● - -	● - -
<b>Dynamic braking chopper</b>	Range of resistors available from ABB	-(ACS55), ● (ACS150)	●	-
<b>Switching frequency</b>		4 to 16 kHz	4 to 12 kHz	4 to 16 kHz
<b>Motor control</b>	DTC (open/closed loop)	-	-	-
<b>Drives can control induction (IM) PM, SynRM unless stated</b>	Sensorless vector Scalar, VVVF	● (IM)	● (IM) ● (IM)	● (IM)
<b>Programmability</b>	Parameter programming Adaptable programming IEC61131 programmability	uses dip (ACS55), ● (ACS150) - -	● ● (sequencer) -	● - -
<b>Start-up assistance and help</b>	Aids to commissioning and diagnostics	-	● (assistant panel)	● (assistant panel)
<b>Cold configure</b>	Program the drive whilst still in its box	●	●	●
<b>Removable memory module</b>	No recommissioning time needed	-	-	-
<b>Real-time clock</b>	With assistant control panel	-	●	●
<b>I/O built-in</b>	Analogue input/output Digital input/output Speed feedback (encoder) Motor thermal protection STO (safe torque-off)	1 / 0 3 / 1r (ACS55), 5 / 1r (ACS150) - - -	2 / 1 5 / 1r+1t+(3r) ○ ○ configurable ●	2 / 1 5 / 1r+1t+(3r) - ○ configurable -
( ) = via add on expansion module				
<b>+24V live control panel + comms</b>	External 24V supply can be connected	-	○ (MPOW)	-
<b>Fieldbuses</b>	Modbus embedded Fieldbus interface (popular networks) Drive-to-drive link BACnet	- - - -	○ ○ - -	● - - -
<b>Remote monitoring</b>	Report info and status remotely	-	■ (SREA)	■ (SREA)
<b>Safety options (TUV certified hardware)</b>	Emergency stop (CAT.0, CAT.1) Safe torque-off (SIL2/PL d) Safe torque-off (SIL3/PL e) Dedicated safety module, extended safety	- - - -	- ● - -	- - - -
<b>ATEX</b>	ATEX certified for use with ABB motors	-	● Ex tD and DIP only	-
<b>PC tools</b>	DriveConfig tool (programme in box) DriveWindow Light DriveWindow DriveAP IEC 61131 tool Drive Composer (Entry or Pro)	■ (ACS55), - (ACS150) - - - - -	- ■ - - - -	- ■ - - - -
<b>Industry specific products</b>	HVAC	-	-	-
<b>Products with hardware or software specifically designed for the industry specified</b>	Food and beverage Machinery / OEMs in general Water and wastewater Aggregates	○ ● - -	● ○ (IP66/69) ● ○ ● ○ (IP66/69)	○ ● ○ ●

● = standard ○ = option, internal or fitted ■ = option, external - = not available \* = can be bookcase or flat mounted r = relay output, t = transistor output, c = configurable to be input or output



ABB general purpose drives (ACS580 - p43)	ABB drives for HVAC (ACH580 - p47)	ABB drives for water and wastewater (ACQ580 - p51)	ABB industrial drives (ACS800-11,-14,-31 - p67)	ABB industrial drives cabinet-drive (ACS880-07, 17 -37 - p62)	ABB industrial drives and drive modules (ACS880-01, 04 - p56)
3-ph 380 - 480 V: 0.55 - 500 kW	3-ph 208 - 240 V: 0.75 - 75 kW 3-ph 380 - 480 V: 1.1 - 355 kW	3ph 380 - 480 V: 1.1 - 250 kW	3-ph 400 V: 11 - 1400 kW 3-ph 500 V: 15 - 1700 kW 3-ph 690 V: 37 - 1600 kW	3-ph 400 V: 45 - 1400 kW 3-ph 500 V: 45 - 1600 kW 3-ph 690 V: 45 - 3200 kW	3-ph 230 V: 0.55 - 75 kW 3-ph 400 V: 0.55 - 1400 kW 3-ph 500 V: 0.55 - 1400 kW 3-ph 690 V: 4 - 2200 kW
-	-	-	-	○ (>400 kW) ● (880-17) ● (880-37)	-
● (remove EMC screw)	● (remove EMC screw)	● (remove EMC screw)	● (800-11, 800-14) ● (800-31)	● (remove EMC screw)	● (remove EMC screw)
● (580-01)	-	-	○, ■ (800-04 R7/8)	○	○
● (580-04) ● (580-01)	-	-	-	● (800-37)	-
○ (IP55, 580-01)	○ (IP55)	○ (IP55)	○ (800 -11, -31) IP55	-	○ (-01, IP55)
● (580-01) ● (580-04)	-	-	● (800-14) ● (800-11, -31)	-	● (-04*) ● (-01)
● (variable-speed fan)	● (variable-speed fan)	● (variable-speed fan)	●	● (LC range)	● (Fan variable speed)
○	○	○	○ (800-11/31)	-	○
● (to 22 kW), ■ thereafter	● (to 22 kW), ■ thereafter	● (to 22 kW), ■ thereafter	○	○	○
4 to 12 kHz	4 to 12 kHz	4 to 12 kHz	DTC	DTC	DTC
●	●	●	● (IM)	●	●
●	●	●	● (IM)	●	●
●	●	●	●	●	●
●	●	●	-	● (CODESYS)	● (CODESYS)
●	●	●	-	●	●
2 / 2 6 / 3r+(2r+1t)	2 / 2 6 / 3r+(2r+1t)	2 / 2 6 / 3r+(2r+1t)	3+(2) / 2+(2) 7+(6) / 3+(6r)	2+(3) / 2+(1) extra possible 7+(4) / 3r+(2r) extra possible	2+(3) / 2+(1) extra possible 7+(4) / 3r+(2r) extra possible
○ isolated and configurable	○ isolated and configurable	○ isolated and configurable	○ configurable	○ configurable	○ configurable
○ (via CMOD), ● R6 and above	○ (via CMOD), ● R6 and above	○ (via CMOD), ● R6 and	●	●	●
○	○	○	○	○	○
○	○	○	○	○	○
○	○	○	○	○	○
■ (SREA or NETA))	■ (SREA or NETA))	■ (SREA or NETA))	■ (NETA)	■ (NETA)	■ (NETA or SREA))
● (CAT.0 via STO)	● (CAT.0 via STO)	● (CAT.0 via STO)	-	● (CAT.0 via STO), ○ (CAT.1)	● (CAT.0 via STO), ○ (CAT.1)
●	●	●	■	●	●
●	●	●	-	○	○
●	●	●	●	●	●
-	-	-	■ (NPCU req.)	-	-
-	-	-	■ (RDCO req.)	-	-
-	-	-	■ (RDCO req.)	■ Automation Builder	■ Automation Builder
○	○ (offices)	-	-	-	-
○	-	-	xx ○	xx ○	xx ○
-	○ (offices)	●	xx ○	-	-
●	○ (offices)	-	xx ○	xx ○	xx ○

All ABB drives are CE marked  
 Other global approvals such as UL, cUL, CSA, C-Tick, GOST-R also applicable  
 xx = ACS800 and ACS880 can be loaded with industry specific code, like crane, winder, winch, spinning etc ++ = A wide range of encoder interfaces to suit high performance applications  
 Drives and controls, motors and mechanical power transmission catalogue 29

# Low voltage AC drives

## ABB micro drives

0.18 kW to 2.2 kW, ACS55

Motor control method - scalar

200/240 V, 1-phase supply, 3-phase output, 0.18 kW - 2.2 kW

100/120 V, 1-phase supply, 3-phase output, 0.18 kW - 0.37 kW

What is an ABB micro drive, ACS55?

The ABB micro drive meets the requirements of OEMs, machinery builders and panel builders. It is a component that is purchased, together with other components, from a distributor. ABB micro drive is so small and simple that users of contactors and softstarters can switch to the benefits of variable-speed control. The ACS55 is a simple drive, programmed by switches. Extended programming is possible via a PC if required, as is programming without power.

### Highlights

- Quick and easy installation - less than five minutes
- User interface via three rotary switches and a further eight on/off function DIP switches located on panel front
- Can be programmed via DriveConfig if needed to access extended functions (useful to OEMs)
- Compact size and narrow shape
- Ideal drive for DIN-rail mounting
- Two mounting orientations
- 110 V single phase - input gives 240V, 3-phase output
- IP20 as standard
- Potentiometer option
- Integral EMC filter for 1st environment (EN61800-3), unrestricted distribution (C1)
- Optimised switching frequency for low noise (up to 16 kHz silent motor)



Where can it be used?

- Washing machines
- Dishwashers
- Mixers
- Treadmills
- Pizza ovens
- Car washing machines
- Vacuum cleaners
- Rotating billboards
- Sliding doors
- Electric gates
- Dryers

Feature	Advantage	Benefit
No programming is required	Inverter parameter settings with DIP switches and potentiometers. Extended programming is possible via DriveConfig if needed	Faster set up Easier configuration Easy -to-use drive for new users
Compact size and narrow shape	Up to 0.37 kW, 45 mm width; 2.2 kW, 67.5 mm width	Less space required for installation
Removable mounting clip	Removable clip allows DIN-rail and wall-mounting from back and side of the unit	Flexible and easy mounting, book case or flat
DriveConfig kit	Fast and safe configuration of an unpowered drive	Simple programming for high volume OEMs - programming in the box, no mains power needed
EMC	First environment. C1 EMC filters as standard ('E' model)	Low EMC emissions
Automatic switching frequency	Increases switching frequency automatically when drive temperature is decreased	Provides lowest possible noise without derating the drive
110-240 V AC, single-phase supplies	Output always capable of full 240 V, 3-phase, regardless of supply voltage	Can easily replace single-phase cap start motors
RoHS compliance	Compliance achieved during 2007	Environmentally friendly drives

# Low voltage AC drives

## ABB micro drives

ACS55 – Ratings, types, voltages, prices and dimensions

### Dimensions and weights

Frame size	H1 mm	H2 mm	W mm	D mm	Weight Kg
A	170	146.5	45	128	0.65
B	170	146.5	67.5	128	0.70
C	194	171	70	159	1.1
D	226	203	70	159	1.1

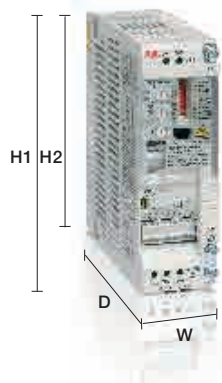

### 200/240 V, 1-phase supply, 3-phase output

Nominal kW	Input current A	Output current A	Max output A	Frame	Fuse A Type gG	Heat dissipation W	Cooling requirements m³/h	Type	Price £
With EMC filter									
0.18	4.4	1.4	2.1	A	10	21	*Nat Vent	ACS55-01E-01A4-2	£98
0.37	6.9	2.2	3.3	A	16	32	*Nat Vent	ACS55-01E-02A2-2	£108
0.75	10.8	4.3	6.5	B	16	51	*Nat Vent	ACS55-01E-04A3-2	£129
1.5	18.2	7.6	11.4	D	25	74	26	ACS55-01E-07A6-2	£179
2.2	22	9.8	14.7	D	32	103	26	ACS55-01E-09A8-2	£209
Without EMC filter									
0.18	4.4	1.4	2.1	A	10	21	*Nat Vent	ACS55-01N-01A4-2	£93
0.37	6.9	2.2	3.3	A	16	32	*Nat Vent	ACS55-01N-02A2-2	£102
0.75	10.8	4.3	6.5	B	16	51	*Nat Vent	ACS55-01N-04A3-2	£120
1.5	18.2	7.6	11.4	C	25	74	26	ACS55-01N-07A6-2	£167
2.2	22	9.8	14.7	C	32	103	26	ACS55-01N-09A8-2	£196

\* Ensure minimum installation space is provided, see User's Manual for details

### 100/120 V, 1-phase supply, 3-phase output

Nominal kW	Input current A	Output current A	Max output A	Frame	Fuse A Type gG	Heat dissipation W	Cooling requirements m³/h	Type	Price £
With EMC filter									
0.18	6.4	1.4	2.1	A	10	24	*Nat Vent	ACS55-01E-01A4-1	£107
0.37	9.5	2.2	3.3	A	16	35	*Nat Vent	ACS55-01E-02A2-1	£119
Without EMC filter									
0.18	6.4	1.4	2.1	A	10	24	*Nat Vent	ACS55-01N-01A4-1	£103
0.37	9.5	2.2	3.3	A	16	35	*Nat Vent	ACS55-01N-02A2-1	£112

\* Ensure minimum installation space is provided, see User's Manual for details



### Options and interfaces

#### Potentiometer

Potentiometer with two switches: start/stop and forward/reverse direction. No external power source is needed for the potentiometer, connects directly to drive I/O.



#### DriveConfig programming with no power

To increase the number of applications possible with the ACS55, the DriveConfig kit can be used to access an extended parameter set. It is still possible to programme in the usual way, if these extended features are not required. DriveConfig also allows programming in the box without power.

# Low voltage AC drives

## ABB micro drives

0.37 kW to 4 kW, ACS150

Motor control method - scalar

200/240 V, 1-phase supply, 0.37 kW - 2.2 kW

200/240 V, 3-phase supply, 0.37 kW - 2.2 kW

380/480 V, 3-phase supply, 0.37 kW - 4 kW

What is an ABB micro drive, ACS150?

The ABB micro drive meets the requirements of OEMs, machinery builders and panel builders. It is a component that is purchased, together with other components, from a logistical distributor. ABB micro drives are designed to encourage users of contactors and softstarters to move to the benefits of variable-speed control. The ACS150 extends the capability of the ACS55 (page 30), by adding an extended range of power frames and programmability. The ACS150 can solve more difficult tasks like PID functionality. To retain the simplicity of an ABB micro drive, the ACS150 does not have a serial communications interface or extended options but does have a fixed keypad and speed control potentiometer.

### Highlights

- PID controller built-in
- DC hold stop ensures stationary motor shaft
- IR compensation improves starting torque for heavy loads
- Parameter lock prevents tampering by unauthorised staff
- DIN rail or screw mounting as standard
- IP20 enclosure
- Fixed basic control panel
- Two-year warranty
- Flashdrop - parameter programming whilst drive still in its box - excellent for OEMs
- Protected against wiring errors: shows fault if power cable is inadvertently connected to motor terminals
- Automatic noise reduction
- Optional short or long parameter mode for standard or advanced users
- Unified height across the power range simplifies cabinet design



Where can it be used?

ACS150 can be used to control less demanding components in any machine, fans or pumps or anywhere where a fixed speed motor needs to go to variable-speed control. The functionality of the drive is designed to compliment the ABB machinery drives and ABB motion control drives.

Feature	Advantage	Benefit
FlashDrop*	Faster and easier drive set-up and commissioning for volume manufacturing. Programming in the box	No need for high voltage safe programming areas Parameters can be hidden for clarity Programme the drive during machine production build-up
Fixed interface	Simple drive with comfortable and robust interface Easy to navigate parameter structure	Integrated control panel with clear LCD, backlight and buttons for editing and control
Fixed potentiometer	Intuitive speed setting	Integrated potentiometer. Settings shown on the control panel
Programmable functions	Useful control functions like PID, accelerating rates and start/stop modes included	Take control of the motor and reduce cost in the installation
Built-in EMC filter	No need for external filtering	2nd environment built-in filter. Complying with IEC 61800-3 as standard
Built-in brake chopper	Reduced cost, saved space and simple wiring	100 percent braking capability
Flexible installation	Optimum layout and efficient cabinet space usage	Screw, DIN-rail, sideways and side-by-side mounting Unified height and depth
Drive protection	Latest solutions to protect the drive and offer troublefree use and the highest quality	The drive protects itself when power is connected to the motor terminals. I/O protected against short-circuit. Coated boards included as standard
Brand labelling	Drive logo, control panel logo, manuals and box can be printed with machine builders logo and name	Drives and packaging badged to your design
RoHS compliance	Compliance achieved during 2007	Environmentally friendly drives

\* For details of FlashDrop, see user interfaces in ABB machinery drive section (page 38)



# Low voltage AC drives

## ABB micro drives

ACS150 – Ratings, types, voltages and prices

### 200/240 V, 1-phase supply voltage

Nominal kW	Nominal output current A	Max output A	Frame	Fuse A Type gG	Heat dissipation W	Cooling requirements m³/h	Type	List Price £
0.37	2.4	4.2	R0	10	25	+Nat Vent	ACS150-01E-02A4-2	£105
0.75	4.7	8.2	R1	16	46	24	ACS150-01E-04A7-2	£123
1.1	6.7	11.7	R1	20	71	24	ACS150-01E-06A7-2	£155
1.5	7.5	13.1	R2	25	73	21	ACS150-01E-07A5-2	£174
2.2	9.8	17.2	R2	35	96	21	ACS150-01E-09A8-2	£208

+ Ensure enough space around the unit - refer to the User's Manual for details

### 200/240 V, 3-phase supply voltage

3-phase, 240 V is available for customers supplying the North American market. Please enquire for details.

### 380/480 V, 3-phase supply voltage

Nominal kW	Nominal output current A	Max output A	Frame	Fuse A Type gG	Heat dissipation W	Cooling requirements m³/h	Type	List Price £
0.37	1.2	2.1	R0	10	11	+Nat Vent	ACS150-03E-01A2-4	£167
0.55	1.9	3.3	R0	10	16	+Nat Vent	ACS150-03E-01A9-4	£177
0.75	2.4	4.2	R1	10	21	13	ACS150-03E-02A4-4	£193
1.1	3.3	5.8	R1	10	31	13	ACS150-03E-03A3-4	£212
1.5	4.1	7.2	R1	16	40	13	ACS150-03E-04A1-4	£231
2.2	5.6	9.8	R1	16	61	19	ACS150-03E-05A6-4	£331
3	7.3	12.8	R1	16	74	24	ACS150-03E-07A3-4	£398
4	8.8	15.4	R1	20	94	24	ACS150-03E-08A8-4	£453

+ Ensure enough space around the unit - refer to the User's Manual for details

The drive can be fitted with the NEMA 1 kit for easy wall-mounting and convenient protection, see user interfaces in ABB machinery drive section, page 38.



# Low voltage AC drives

## ABB micro drives

ACS150 – Dimensions, I/O and options

### Dimensions and weights

#### Cabinet-mounted drives, wall mounted drives

Frame size	IP20 (UL open)						NEMA 1				
	H1	H2	H3	W	D	Weight	H4	H5	W	D	Weight
	mm	mm	mm	mm	mm	Kg	mm	mm	mm	mm	Kg
R0	169	202	239	70	142	1.1	257	280	70	142	1.5
R1	169	202	239	70	142	1.3	257	280	70	142	1.5
R2	169	202	239	105	142	1.5	257	282	105	142	1.5

H1 = Height without fastenings and clamping plate  
 H2 = Height with fastenings but without clamping plate  
 H3 = Height with fastenings and clamping plate  
 H4 = Height with fastenings and NEMA 1 connection box  
 H5 = Height with fastenings, NEMA 1 connection box and hood  
 W = Width  
 D = Depth

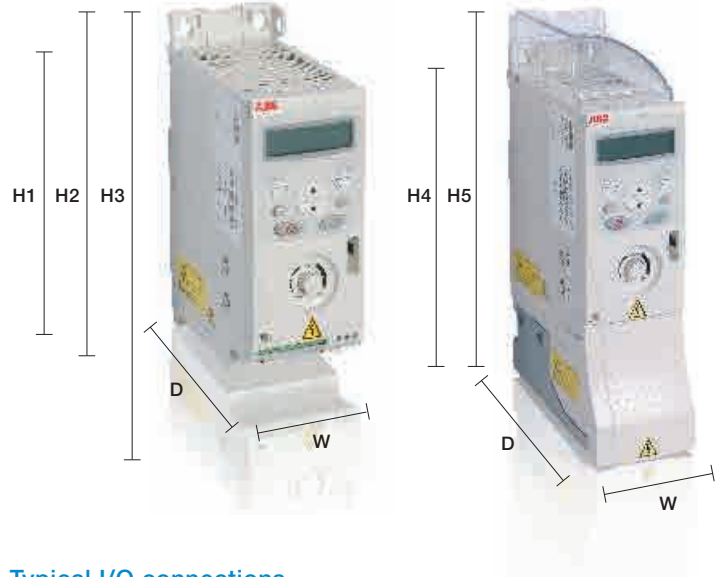

### Options available

- Input and output chokes
- Brake chopper resistors (all drives in the ACS150 range have integral chopper)
- First environment EMC filters - footprint style
- Low leakage EMC filters < 30 mA leakage
- FlashDrop - programming without power
- NEMA kit allows installations to be neater and provides mechanical support for glanded cables

### Typical I/O connections

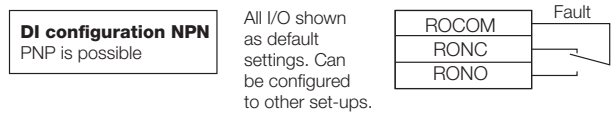
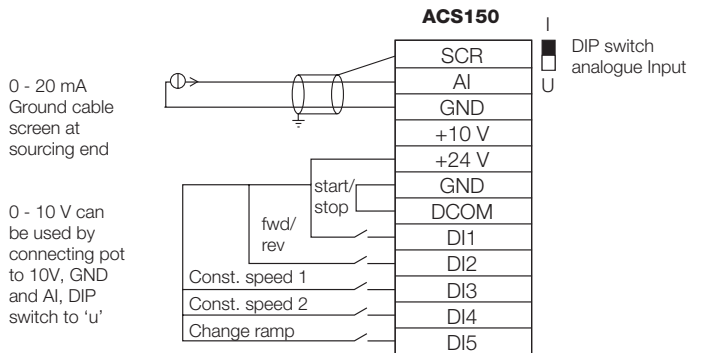

### User interfaces

The ACS150 has a simple user interface, consisting of I/O connections and a fixed programming keypad. An integrated speed control potentiometer is also provided.

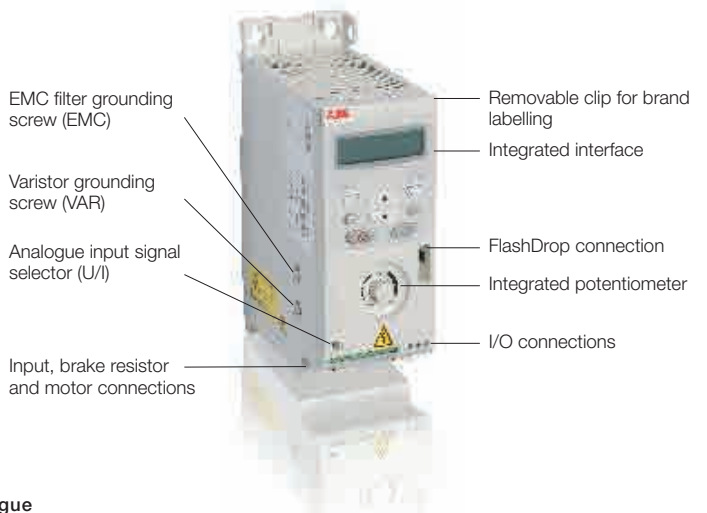

# Low voltage AC drives

## ABB machinery drive

0.37 kW to 22 kW, ACS355

Motor control method - scalar, vector (open and closed loop)

200/240 V, 1-phase supply, 0.37 kW - 2.2 kW

200/240 V, 3-phase supply, 0.37 kW - 11 kW

380/480 V, 3-phase supply, 0.37 kW - 22 kW

What is an ABB machinery drive?

ABB machinery drives are designed for the machine building sector. In serial type manufacturing the consumed time per unit is critical. The drive is designed to be optimal in terms of installation, setting parameters, available machinery features and commissioning. The basic product is user-friendly, yet provides high intelligence. The drive offers diverse functionality to cater for the most demanding needs. The drive is also equipped with a dual-channel safe torque-off interface to SIL3/PL e.

### Highlights

- FlashDrop - parameter programming with drive still in its box - excellent for OEMs
- Sequence programming designed for food and beverage and materials handling applications - Eight-steps included
- Unified height and depth across the power range simplifies cabinet design
- Protected against wiring errors: shows fault if power cable is inadvertently connected to motor terminals
- Automatic noise reduction
- Own branding possible for large users



Where can it be used?

ABB machinery drives are designed to meet the requirements of an extensive range of machinery applications. The drive is ideal for food and beverage, material handling, textile, printing, rubber and plastics and woodworking applications. The higher IP66 class variant meets all of the relevant hygiene requirements for the food and beverage industry.

Feature	Advantage	Benefit
FlashDrop*	Faster and easier drive set-up and commissioning for volume manufacturing. Programming with no power	Fast, safe and troublefree method to set up and commission without powering up the drive - patented
Safe torque-off	Built-in compliance to new machinery directive	SIL3/PL e certified dual channel input - TÜV approved
Sequence programming	Application specific 8-state programming with comprehensive triggering conditions, 16 conditions with option code	Logic programming included as standard. Reduces the need for external PLC
Common DC link	Connection to existing DC power sources (patented)	Easy integration into high performance machines
User interfaces	Wide range, including Assistant panel	Cost efficient approach - meets requirements of OEM
Fieldbus	Extensive range of industrial fieldbus option modules available	Connectability to all of the most popular fieldbuses
24 V 'live keypad' operation	Connect 24 V to the drive via the MPOW option	Keep fieldbus, control card and I/O healthy while able to remove the main supply - safer maintenance
Built-in EMC filter	2nd environment filter complying with IEC 61800-3 as standard	No extra space, parts, time or cost required
Built-in brake chopper	100 percent braking capability	Reduces cost, saves space and simplifies wiring
Drive protection	Latest solutions to protect the drive and offer troublefree use and the highest quality	The drive protects itself when power is connected to the motor terminals. I/O protected against short-circuit. Coated boards included as standard
IP66/69k enclosure option	Makes drive suitable for hose down applications	Meets food hygiene standards in a wall-mounted enclosure
Brand labelling	Drive logo, control panel logo, manuals and box can be printed with machine builders logo and name	Drives and packaging badged to your design
RoHS compliance	Compliance achieved during 2007	Environmentally friendly drives

\* For details of FlashDrop, see user interfaces in ABB machinery drive section, page 38

# Low voltage AC drives

## ABB machinery drive

ACS355 - Ratings, types, voltages and prices

### 200/240 V, 1-phase supply voltage

Nominal	Output current	Max output	Frame	Fuse A	Heat dissipation	Cooling requirements	Type (code shown is IP20)	IP20 list price without control panel*	IP66 list price with control panel**
kW	A	A		Type gG	W	m <sup>3</sup> /h			
0.37	2.4	4.2	R0	10	48	*Nat Vent	ACS355-01E-02A4-2	£117	n/a
0.75	4.7	8.2	R1	16	72	24	ACS355-01E-04A7-2	£146	n/a
1.1	6.7	11.7	R1	20	97	24	ACS355-01E-06A7-2	£172	n/a
1.5	7.5	13.1	R2	25	101	21	ACS355-01E-07A5-2	£188	n/a
2.2	9.8	17.2	R2	35	124	21	ACS355-01E-09A8-2	£230	n/a

\* Ensure enough space around the unit - refer to the User's Manual for details

\* Note: IP20 drives require a keypad for parameter alteration, it can then be removed if required

\*\* Note: IP66 drives are always delivered with the Assistant keypad

### 200/240 V, 3-phase supply voltage

3-phase, 240 V is also available for customers supplying the North American market. Please enquire for details.

### 380/480 V, 3-phase supply voltage

Nominal	Output current	Max output	Frame	Fuse A	Heat dissipation	Cooling requirements	Type (code shown is IP20)	IP20 list price without control panel*	IP66 list price with control panel**
kW	A	A		Type gG	W	m <sup>3</sup> /h			
0.37	1.2	2.1	R0	10	35	*Nat Vent	ACS355-03E-01A2-4	£199	£420
0.55	1.9	3.3	R0	10	40	*Nat Vent	ACS355-03E-01A9-4	£209	£423
0.75	2.4	4.2	R1	10	50	13	ACS355-03E-02A4-4	£229	£438
1.1	3.3	5.8	R1	10	60	13	ACS355-03E-03A3-4	£260	£487
1.5	4.1	7.2	R1	16	69	13	ACS355-03E-04A1-4	£315	£553
2.2	5.6	9.8	R1	16	90	19	ACS355-03E-05A6-4	£366	£630
3	7.3	12.8	R1	16	107	24	ACS355-03E-07A3-4	£477	£816
4	8.8	15.4	R1	20	127	24	ACS355-03E-08A8-4	£543	£927
5.5	12.5	21.9	R3	25	161	52	ACS355-03E-12A5-4	£629	£1,096
7.5	15.6	27.3	R3	30	204	52	ACS355-03E-15A6-4	£816	£1,299
11	23.1	40.4	R3	50	301	71	ACS355-03E-23A1-4	£997	n/a
15	31.0	54.3	R4	80	408	96	ACS355-03E-31A0-4	£1,277	n/a
18.5	38.0	66.5	R4	100	498	96	ACS355-03E-38A0-4	£1,516	n/a
22	44.0	77.0	R4	100	588	96	ACS355-03E-44A0-4	£1,853	n/a

\* Ensure enough space around the unit - refer to the User's Manual for details

\* Note: IP20 drives require a keypad for parameter alteration, it can then be removed if required

\*\* Note: IP66 drives are always delivered with the Assistant keypad

### Control panel

Control panel	Type	Price
		£
Assistant control panel	ACS-CP-A	£94†
Basic keypad	ACS-CP-C	£27

† Price of control panel only when purchased with drive

Panel mounting kit and user interface descriptions, see page 38

# Low voltage AC drives

## ABB machinery drive

ACS355 – Dimensions, I/O and options

### Dimensions and weights

IP20 UL Open								NEMA 1/UL Type 1						IP66/67/UL Type 4x			
Frame	H1	H2	H3	W	D1	D2	Weight	H4	H5	W	D1	D2	Weight	H	W	D1	Weight
size	mm	mm	mm	mm	mm	mm	Kg	mm	mm	mm	mm	mm	Kg	mm	mm	mm	Kg
R0	169	202	239	70	161	187	1.2	257	280	70	169	187	1.6	-	-	-	-
R1	169	202	239	70	161	187	1.2	257	280	70	169	187	1.6	305	195	281	7.7
R2	169	202	239	105	165	191	1.5	257	282	105	169	191	1.9	-	-	-	-
R3	169	202	236	169	169	195	2.5	260	299	169	177	195	3.1	436	246	277	13
R4	181	202	244	260	169	195	4.4	270	320	260	177	195	5.0	-	-	-	-

H = Height  
 H1= Height without fastenings and clamping plate  
 H2 = Height with fastenings but without clamping plate  
 H3 = Height with fastenings and clamping plate  
 H4 = Height with fastenings and NEMA 1 connection box  
 H5 = Height with fastenings, NEMA 1 connection box and hood  
 W = Width  
 D1 = Standard depth  
 D2 = Depth with MREL or MTAC option

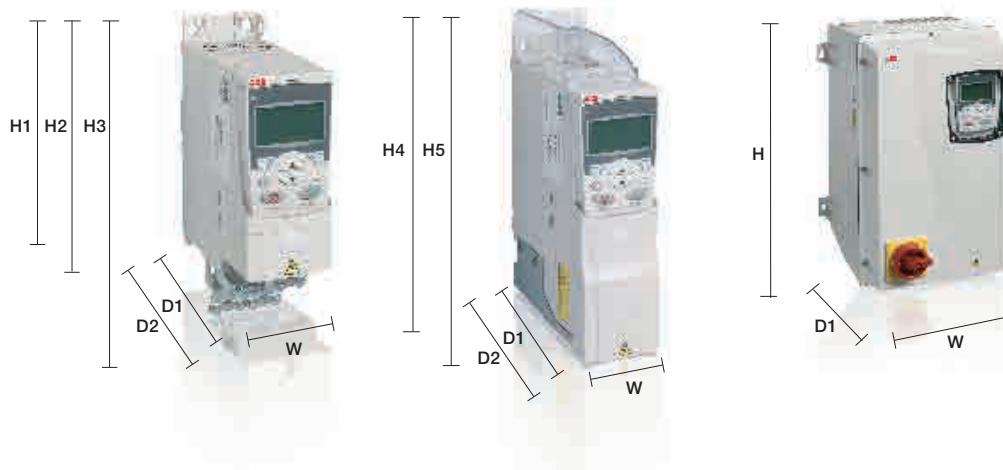

### STO connections

The ACS355 has a dual channel STO (safe torque-off) input as standard, certified to BS EN 62061 and BS EN 13849-1

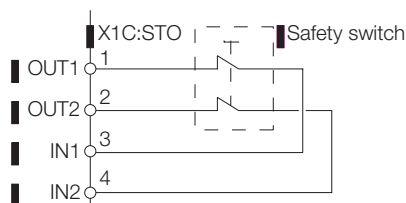

### Options available

- Input and output chokes
- Brake chopper resistors (all drives in the ACS355 range have integral chopper)
- First environment EMC filters - footprint style
- Low leakage EMC filters < 30 mA leakage
- FlashDrop, programming in the box without power
- Fieldbus modules
- NEMA kit allows installations to be neater and provides mechanical support for glanded cables
- An extensive range of user interfaces is available - please see following pages
- IP66 pressure relief valves

### Typical control connections

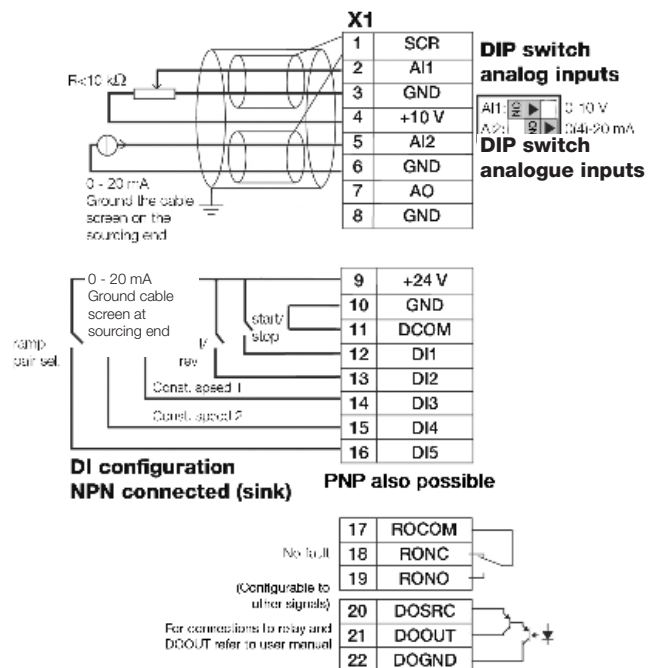

# Low voltage AC drives

## ABB machinery drive

ACS355 – User interfaces

### Assistant control panel (+J400)

Features a multilingual alphanumeric display for easy drive programming. The control panel has various assistants and a built-in help function to guide the user. It includes a real-time clock, which is used during fault logging and in controlling the drive, such as start/stop. The control panel can be used for copying parameters for backup or for downloading to another drive. A large graphical display and soft keys make it extremely easy to navigate.



### Basic control panel (+J404)

Features a single line numeric display. The panel can be used to control the drive, set the parameter values or copy them from one drive to another, or view changes.



### Panel cover

The panel cover protects the drive when no control panel is used. The ABB machinery drive is delivered with a panel cover as standard. In addition, there are two alternative control panels available as options, see above.



### NEMA 1 kit

The NEMA 1 kit is a convenient cover which is added to the drive and enables easy wall-mounting. It includes a connection box for cable gland or conduit tube installation and a hood for protection against dirt and dust.



### Panel mounting kits, IP54 and IP66

The panel mounting kits enable mounting of control panels onto cabinet doors. These kits include a 3 m extension cable, a gasket, mounting screws and a mounting template - two versions are now available, IP54 and IP66. The IP66 has an additional keypad membrane cover.

Note: IP66 cover is not suitable for outdoor use.



### Relay extension module (+L511)

Add an additional three relays to the ACS355 to allow greater use of the drives programme. Fits behind the keypad.



### Potentiometer (+J402)

Potentiometer with two switches: start/stop and forward/reverse direction. No external power source is needed for the potentiometer. Fits to the drive I/O.



### FlashDrop

Programme the drive whilst still in the box, with no power. Perfect for OEMs and machine builders. FlashDrop is a powerful palm-sized tool for fast and easy parameter selecting and setting. It gives the possibility to hide selected parameters to protect the machine. The tool stores 20 parameter sets, which can be moved between a PC and a drive. Safe programming during machine building production for unskilled staff.



### Fieldbus interfaces

Extensive range of plug-in fieldbus interfaces, allowing connection to Profibus, DeviceNet, CanOpen, Modbus RTU and Ethernet and many others.



### 24V “live keypad” options

There are two ways of powering the fieldbus modules, so that they operate when the main power is removed.

FEPA - maintains power to the fieldbus module only.

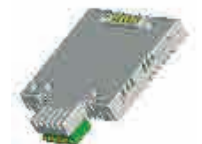

MPOW (+G406) - powers the fieldbus module, the control card, the drive I/O and the drive keypad, generating the functionality commonly known as ‘live keypad’ operation.



### DriveWindow Light PC tool

The tool is a parameterisation and commissioning tool used to set-up and commission the drive. Monitoring and diagnostic facilities are included, as well as a local control panel. Wizards are included to guide the user through the most commonly performed tasks.

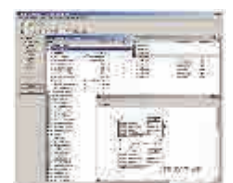

4

# Low voltage AC drives

## ABB general purpose drive for fans and pumps

0.37 kW to 22 kW, ACS310

Motor control method – scalar

200/240 V, 1-phase supply, 0.37 kW - 2.2 kW

200/240 V, 3-phase supply, 0.37 kW - 11 kW

380/480 V, 3-phase supply, 0.37 kW - 22 kW

What is an ABB general purpose drive for fans and pumps?

A dedicated fan and pump controller, designed for squared-torque applications such as booster, submersible and irrigation pumps and centrifugal fans.

The drive benefits pump and fan applications with features including built-in PID controllers and PFC (pump and fan control). The drives also have pre-programmed protection functions such as pipe cleaning (anti-jam) and duty standby functionality, including soft pipe filling to reduce leaks.

These features, combined with pre-programmed application macros, an intuitive user interface, and several assistant screens, speed up the installation, parameter setting and commissioning of the drive.

### Highlights

- Pump, soft pump and fan control (PFC and SPFC), for multi-pump and soft fill control
- Pipe cleaning (anti-jam) and pipe fill functions
- Multiple PID set points, allowing for automatic duty/assist/standby schemes to be implemented
- Energy efficiency counters, real-time clock
- Energy optimiser – optimises the motor control for the application to run with minimum energy requirements
- Load analyser for optimised dimensioning of the drive, motor and process
- Embedded Modbus RS-485 fieldbus interface
- FlashDrop tool for fast parameter setting, without mains power



For more details, please refer to Technical Catalogue 3AUA0000051082

Where can it be used?

The ABB general purpose drive's software features are ideal for solving the challenges and issues surrounding pumping in general, and those of water and wastewater in particular.

The drive is designed to compliment the features offered by the industry specific products for water and wastewater (see page 51).

Feature	Advantage	Benefit
Pump and fan control (PFC) feature to control pumps and fans in parallel	One drive controls several pumps or fans and eliminates the need for an external programmable logic controller Interlock function enables one motor to be disengaged from the mains supply while others continue operating in parallel	Saves cost of additional drives and external PLC Longer life for pump or fan system while reducing maintenance time and costs. Maintenance can be carried out safely without stopping the process
Soft pump and fan control feature (SPFC)	Reduces unwanted pressure peaks in pumps and pipelines when an auxiliary motor is started or main pump started	Reduces maintenance costs and leaks typically seen in DOL starting. Longer life for pump or fan system. Ideal for irrigation systems
Pump protection functions	Pre-programmed features like: Pipe cleaning (anti-jamming), inlet/outlet pressure supervision and detection of under or overload for preventive maintenance	Reduces maintenance costs Smoother processes: improved and optimised system Longer life for pump and fan system, reduced maintenance costs
Energy monitoring and optimising features	Drive monitors the saved energy compared to equivalent DOL operation Drive controls the motor voltage dependant on the load	Energy savings presented in local currency and CO <sub>2</sub> Consumed energy optimised across the speed and load range
Full output current at 50°C ambient	Drive can be operated in ambient temperatures up to 50°C without de-rating the output current	Optimised drive dimensioning for wide temperature range
Unified height and depth	Optimum installation layout, as all drive frames are the same height – only the width changes	Space savings. Easier to lay the cabinet back panel out
Best-in-class user interfaces	Assistant and Basic keypads with intuitive operation. Short and long menus, Assistants and wizards for ease of use	Users are supported as they program the drive, can tailor the open menu views to suite there customer needs
FlashDrop*	Faster and easier drive set up and commissioning for volume manufacturing	Fast, safe and troublefree method to set up and commission without powering up the drive - patented
RoHS compliance	Compliance achieved during 2007	Environmentally friendly drives

\* For details of FlashDrop, see user interfaces (page 42)

# Low voltage AC drives

## ABB general purpose drive for fans and pumps

ACS310 – Ratings, types, voltages and prices

### 200/240 V, 1-phase supply voltage

Nominal kW	Nominal output current A	Max output A	Frame	Fuse A Type gG	Heat dissipation W	Cooling requirements m <sup>3</sup> /h	Type	IP20 list price without control panel*
0.37	2.4	4.0	R0	10	48	+Nat Vent	ACS310-01E-02A4-2	£116
0.75	4.7	7.9	R1	16	72	24	ACS310-01E-04A7-2	£132
1.1	6.7	11.4	R1	20	97	24	ACS310-01E-06A7-2	£154
1.5	7.5	12.6	R2	25	101	21	ACS310-01E-07A5-2	£171
2.2	9.8	16.5	R2	35	124	21	ACS310-01E-09A8-2	£207

+ Ensure enough space around the unit - refer to the User's Manual for details

\* Drives require a control panel for parameter alteration, it can then be removed if required  
For 50°C ratings contact ABB

### 200/240 V, 3-phase supply voltage

3-phase, 240 V is available for customers supplying the North American market. Please enquire for details.

### 380/480 V, 3-phase supply voltage

Nominal kW	Nominal output current A	Max output A	Frame	Fuse A Type gG	Heat dissipation W	Cooling requirements m <sup>3</sup> /h	Type	IP20 list price without control panel*
0.37	1.3	2.1	R0	10	35	+Nat Vent	ACS310-03E-01A3-4	£180
0.55	2.1	3.3	R0	10	40	+Nat Vent	ACS310-03E-02A1-4	£189
0.75	2.6	4.2	R1	10	50	13	ACS310-03E-02A6-4	£207
1.1	3.6	5.8	R1	10	60	13	ACS310-03E-03A6-4	£230
1.5	4.5	7.2	R1	15	69	13	ACS310-03E-04A5-4	£300
2.2	6.2	9.8	R1	15	90	19	ACS310-03E-06A2-4	£331
3	8	12.8	R1	20	107	24	ACS310-03E-08A0-4	£425
4	9.7	15.4	R1	25	127	24	ACS310-03E-09A7-4	£482
5.5	13.8	21.9	R3	30	161	52	ACS310-03E-13A8-4	£560
7.5	17.2	27.3	R3	35	204	52	ACS310-03E-17A2-4	£738
11	25.4	40.4	R3	50	301	71	ACS310-03E-25A4-4	£900
15	34.1	54.3	R4	80	408	96	ACS310-03E-34A1-4	£1,157
18.5	41.8	66.5	R4	100	498	96	ACS310-03E-41A8-4	£1,349
22	48.4	77.0	R4	100	588	96	ACS310-03E-48A4-4	£1,648

+ Ensure enough space around the unit - refer to the User's Manual for details

\* Drives require a control panel for parameter alteration, it can then be removed if required  
For 50°C ratings contact ABB

### Control panel

Control panel	Type	Price £
Assistant control panel	ACS-CP-A	£94**
Basic keypad	ACS-CP-C	£27

\*\* Price of control panel only when purchased with drive  
Panel mounting kit and user interface descriptions, see page 42



# Low voltage AC drives

## ABB ACS310 general purpose drive for fans and pumps

ACS310 – Dimensions, I/O and options

### Dimensions and weights

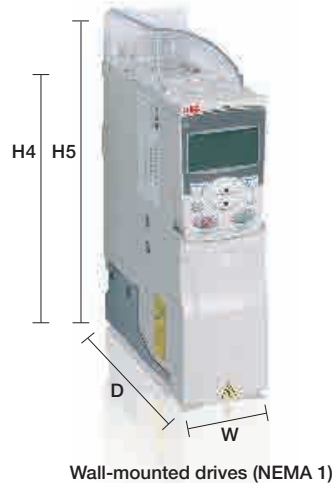
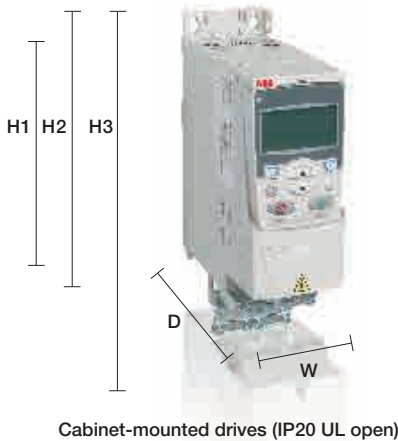

Frame size	IP20 UL open						NEMA 1/UL Type 1				
	H1 mm	H2 mm	H3 mm	W mm	D mm	Weight Kg	H4 mm	H5 mm	W mm	D mm	Weight Kg
R0	169	202	239	70	161	1.1	257	280	70	169	1.5
R1	169	202	239	70	161	1.3	257	280	70	169	1.7
R2	169	202	239	105	165	1.5	257	282	105	169	1.9
R3	169	202	236	169	169	2.9	260	299	169	177	3.5
R4	181	202	244	260	169	4.4	270	320	260	177	5.0

H1 = Height without fastenings and clamping plate  
 H2 = Height with fastenings but without clamping plate  
 H3 = Height with fastenings and clamping plate  
 H4 = Height with fastenings and NEMA 1 connection box  
 H5 = Height with fastenings, NEMA 1 connection box and hood  
 W = Width  
 D = Depth

### Options available

- Input and output chokes
- ACS310 has no braking options
- First environment EMC filters - footprint style
- Low leakage EMC filters < 30 mA leakage
- FlashDrop
- NEMA kit allows installations to be neater and provides mechanical support for glanded cables
- An extensive range of user interfaces is available - please see following pages

### Typical control connections

- All I/O are programmable for other configurations

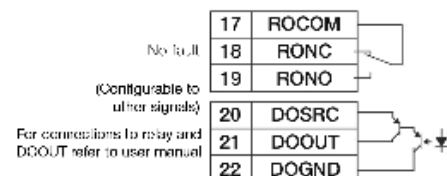
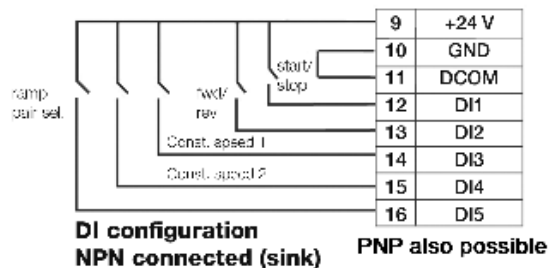
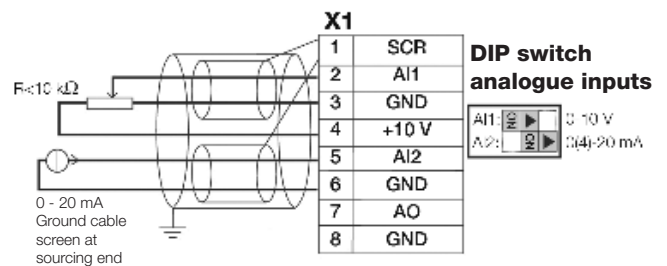

# Low voltage AC drives

## ABB general purpose drive for fans and pumps

ACS310 – User interfaces

### Assistant control panel (+J400)

Features a multilingual alphanumeric display for easy drive programming. The control panel has various assistants and a built-in help function to guide the user. It includes a real-time clock, which is used during fault logging and in controlling the drive, such as start/stop. The control panel can be used for copying parameters for backup or for downloading to another drive. A large graphical display and softkeys make it extremely easy to navigate.



### Basic control panel (+J404)

Features a single line numeric display. The panel can be used to control the drive, set the parameter values or copy them from one drive to another.



### Panel cover

The panel cover protects the drive's connection when no control panel is used. The ABB general purpose drive is delivered with a panel cover as standard, thereby providing a cost effective package. In addition, there are two alternative control panels available as options, see above.



### NEMA 1 kit

The NEMA 1 kit is a convenient cover which is added to the drive and enables easy wall-mounting. It includes a connection box for cable gland or conduit tube installation and a hood for protection against dirt and dust.



### Panel mounting kit, IP54 and IP66

The panel mounting kit enables mounting of control panels on cabinet doors. These kits include a 3 m extension cable, a gasket, mounting screws and a mounting template - two versions are now available, IP54 and IP66. The IP66 has an additional keypad membrane cover.



Note: IP66 cover is not suitable for outdoor use.

### Relay extension module (+L511)

Add an additional three relays to the ACS310 to allow greater use of the PFC program. Fits behind the keypad.



### FlashDrop

Programme the drive whilst still in the box, with no power. Perfect for OEMs and machine builders. FlashDrop is a powerful palm-sized tool for fast and easy parameter selecting and setting. It gives the possibility to hide selected parameters to protect the machine. The tool stores 20 parameter sets, which can be moved between a PC and a drive. Safe programming during machine building production for unskilled staff.



### Fieldbus communications

ACS310 has no industrial fieldbus interfaces, but it does have an RS485 Modbus communications link built-in. This link can be used to communicate to industrial HMIs or remote monitoring devices or to a fieldbus via a suitable gateway.

### DriveWindow Light PC tool

This tool is a parameterisation and commissioning tool used to set-up and commission the drive. Monitoring and diagnostic facilities are included, as well as a local control panel. Wizards are included to guide the user through the most commonly performed tasks.



# Low voltage AC drives

## ABB general purpose drive

0.55 kW to 500 kW, ACS580

Motor control method – scalar or vector control (open or closed loop)

380 - 480 V, 3-phase supply, 0.55 kW to 500 kW

### What is an ABB general purpose drive?

The ACS580 is stocked and delivered by ABB's authorised value provider network, and handles a very wide range of applications. It is a highly useable drive incorporating ABB's most intuitive keypad functionality. The "primary settings" guide the user much like a smart phone. The drive retains the swinging choke harmonic suppression technology, which has been updated to permanent magnet technology. The drive includes built-in machinery safety functionality with safe torque-off (STO) to SIL 3 PL e as standard, and has more frames to optimise the commercial and power offering.

### Highlights

- Improved internal options including external 24 V support
- Integral EMC filter for 1st and 2nd environment as standard
- Assistant control panel with improved primary settings menu and backups-smartphone useability
- Wide power range in wall-mounted IP21 and IP55 variants
- Extended power range with ACS580-04 and ACS580-07 to 500 kW
- Patented permanent magnet swinging choke for superior harmonic reduction, even at reduced motor loads
- Safe torque-off (STO) as standard, SIL 3 PL e
- Flexible fieldbus system with built-in Modbus and numerous internally mountable fieldbus adapters
- SynRM, permanent magnet (PM) and induction motor (IM) control with improved motor platform



For more details, please refer to Technical Catalogue 3AUA0000145061

### Where can it be used?

The ABB general purpose drive is ideal in those situations where there is a need for simplicity to install, commission and use and where reasonable amounts of flexibility and functionality are required. The addition of STO, 24 V support and improved fieldbus support and wider powers, extends the applications.

Feature	Advantage	Benefit
Intuitive modern keypad	High contrast, high definition display giving intuitive access to the drive parameters. Built-in "Help" button, giving programming hints. Real-time clock, allows timed tracing of faults and setting of parameters to activate functions at various times of day. Changed parameters menu also included, so you can see your edits	Easy commissioning, programming, maintenance and fault finding, making the drive easy to own and use across all activities. Allows drive cloning for easy set up of multiple drives
Primary settings menu	Assisted set-up for all of the drives common settings. Intuitive and context sensitive makes navigation easier for the user, like a smartphone	Even easier to configure the drive to the application. Next level of VSD usability
Text editing capabilities	Rename drive variables or warning messages	Tailor the drive to "speak" in the language of the application
Adaptive programming	Drive contains a freely programmable environment allowing changes and adaptations to the drive parameters. Easy to use and flexible	The drive can easily be flexed to meet the needs of the application, without external devices, existing controls, timers, relays etc
Improved backups	Keypad can store backups with a time stamp, or automatic backups can be taken. Backups can be viewed before download, or partial downloads can be performed	Easy to manage installed base and speeds up commissioning. Auto backup means you never forget
Integrated safety. STO as standard SIL3 PL e	TÜV approved STO is on board the drive. Makes it easy to generate safety systems without the need for external contactors	Minimise installation time and space. Shorter design times using TÜV approved interface
Energy monitoring and optimising features	Drive controls the motor voltage dependant on the load. Drive monitors the saved energy compared to equivalent DOL operation	Consumed energy optimised across the speed and load range. Energy savings presented in local currency and tonnes of CO <sub>2</sub>
24 V operation	Power the drive control card, I/O and fieldbus from an external 24 V. Frames R0 to R5 require a CMOD; standard in R6 and above	Safer diagnostics and maintenance activities can be undertaken without the need for mains voltages
Cold configuration - Programming without mains power whilst in the box	Quicker parameter programming for OEM users. Drive can be programmed with a PC interface that injects the parameters directly into the drive whilst it is still in the box	Quicker, cheaper manufacturing for OEM's. Easier spares handling in store without the need to power on the drive

# Low voltage AC drives

## ABB general purpose drive

ACS580 – Variants, ratings voltages and prices

4



### Wall-mounted single drive Series ACS580-01

- 0.55 kW to 250 kW, (380 - 480 V)
- Largest power for wall-mount drive on market
- Coated boards as standard
- Variable-speed cooling fans
- TÜV approved safe torque-off (STO) to SIL 3 PL e standard
- IP21 as standard, IP55 as option
- IP55 variant similar footprint to IP21 variant
- Brake chopper standard to R3 frame, option thereafter
- Optional UK cable box for SWA cables
- EMC filter for C3 category according to EN 61800-3 (2004) standard
- Internal fieldbus options
- Optional relay expansion, PTC and 115 V/240 V DI's

### Cabinet built single drives Series ACS580-07

- 250kW to 500kW
- Contains the 580-04 module described below, so adopts all of its features
- Optimised list of options covering IP rating, cable entry and door furniture, to ensure a fast and efficient build and delivery time schedule
- New cabinet designs containing the ACS580-01 module expected in 2017



### Cabinet mounted single drive Series ACS580-04

- 250 kW to 500 kW
- Most compact floor standing module
- Coated boards as standard
- Variable-speed redundant cooling fans
- TÜV approved safe torque-off (STO) to SIL 3 PL e
- IP00 module, mounted on wheels
- Brake chopper optional
- EMC, fieldbus and relay expansion as per ACS580-01

### 380 – 480 V, 3-phase supply voltage (ratings shown are for 415 V)

No-overload (nominal) use		Light-duty use		Heavy-duty use		Max output A	Frame	Fuse A	Heat dissipation	Cooling requirements	Type (+J400 + H358 to order keypad & SWA gland plate)	Price IP21	Price IP55 (+B056)
P <sub>N</sub> kW	I <sub>N</sub> A	P <sub>Ld</sub> kW	I <sub>Ld</sub> A	P <sub>hd</sub> kW	I <sub>hd</sub> A			Type gG	W	m <sup>3</sup> /h		£	£
0.75	2.6	0.75	2.5	0.55	1.8	3.2	R0	4	45	34	ACS580-01-02A6-4	£466	£547
1.1	3.3	1.1	3.1	0.75	2.6	4.7	R0	6	55	34	ACS580-01-03A3-4	£490	£582
1.5	4	1.5	3.8	1.1	3.3	5.9	R0	6	66	34	ACS580-01-04A0-4	£587	£661
2.2	5.6	2.2	5.3	1.5	4	7.2	R0	10	84	34	ACS580-01-05A6-4	£644	£732
3	7.2	3	6.8	2.2	5.6	10.1	R1	10	106	50	ACS580-01-07A2-4	£703	£781
4	9.4	4	8.9	3	7.2	13	R1	16	133	50	ACS580-01-09A4-4	£790	£918
5.5	12.6	5.5	12	4	9.4	14.1	R1	16	174	50	ACS580-01-12A6-4	£938	£1,031
7.5	17	7.5	16.2	5.5	12.6	22.7	R2	25	228	128	ACS580-01-017A-4	£1,073	£1,248
11	25	11	23.8	7.5	17	30.6	R2	32	322	128	ACS580-01-025A-4	£1,286	£1,456
15	32	15	30.4	11	24.6	44.3	R3	40	430	116	ACS580-01-032A-4	£1,571	£1,753
18.5	38	18.5	36.1	15	31.6	56.9	R3	50	525	116	ACS580-01-038A-4	£1,976	£2,178
22	45	22	42.8	18.5	37.7	67.9	R3	63	619	116	ACS580-01-045A-4	£2,369	£2,553
30	62	30	58	22	45	76	R4	80	835	134	ACS580-01-062A-4	£2,966	£3,123
37	73	37	68	30	61	104	R4	100	1024	134	ACS580-01-073A-4	£3,287	£3,462
45	88	45	82.7	37	72	122	R5	100	1240	139	ACS580-01-088A-4	£4,084	£4,302
55	106	55	100	45	87	148	R5	125	1510	139	ACS580-01-106A-4	£4,236	£4,460
75	145	75	138	55	105	178	R6	160	1476	435	ACS580-01-145A-4	£4,762	£5,063
90	189	90	161	75	145	247	R7	250	1976	450	ACS580-01-169A-4	£6,142	£6,643
110	206	110	196	90	169	287	R7	315	2346	550	ACS580-01-206A-4	£7,907	£8,442
132	246	132	234	110	206	350	R8	355	3336	550	ACS580-01-246A-4	£9,641	£10,174
160	293	160	278	132	246	418	R8	425	3936	1150	ACS580-01-293A-4	£11,465	£12,001
200	363	200	345	160	293	498	R9	500	4836	1150	ACS580-01-363A-4	£13,918	£14,341
250	430	200	400	200	363	617	R9	630	6036	1150	ACS580-01-430A-4	£17,020	£17,631

For 440 to 480 V data see the User's Manual, document code: 3AUA0000076333

For ACS580-04 variant, please contact ABB or your local authorised value provider (see page 8 for details)

# Low voltage AC drives

## ABB general purpose drive

ACS580-01 – Dimensions and options

### Dimensions and weights, wall-mounted drives

IP21				
Frame size	Height mm	Width mm	Depth mm	Weight kg
R0	303	125	210	4.5
R1	303	125	223	4.6
R2	394	125	227	7.5
R3	454	203	228	14.9
R4	600	203	258	19
R5	732	203	283	23
R6	727	252	369	45
R7	880	284	370	55
R8	965	300	393	70

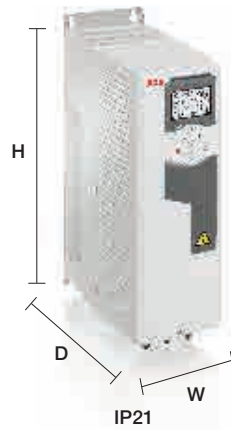

IP55				
Frame size	Height mm	Width mm	Depth mm	Weight kg
R0	303	125	222	5.1
R1	303	125	233	5.1
R2	394	125	239	8.0
R3	454	203	237	15.4
R4	600	203	265	20
R5	732	203	320	29
R6	726	252	380	45.5
R7	880	284	381	55.5
R8	965	300	452	72



### Options for ACS580-01

ACS580-01 is a wall mounted drive, so all options fit inside:

- IP55 variant
- Internal fieldbus options
- Optional additional industrial fieldbus
- Optional relay expansion
- Optional isolated PTC option
- Optional 115/230 V digital inputs
- UK gland box to accommodate SWA cable
- Brake chopper (up to frame R3 fitted as standard)

Apart from IP55, the above also applies to ACS580-04 and ACS580-07.

All ABB general purpose drives use the same common options and user interfaces. These are detailed on page 46. They are also part of the “all compatible family” so keypad interfaces, common PC tools, parameter structures and programming methods are all common, even across other drive ranges.

### Cold configuration adapter – CCA-01

ACS580 drives can be programmed without the need for mains power or without taking the drive out of the box using the CCA-01. This specifically allows rapid programming for OEM without the need for safe areas in production.



### Typical I/O connections for ACS580

These connections are shown as examples only. Please refer to the User's Manual – macro section, for more detailed information and for different I/O configurations.

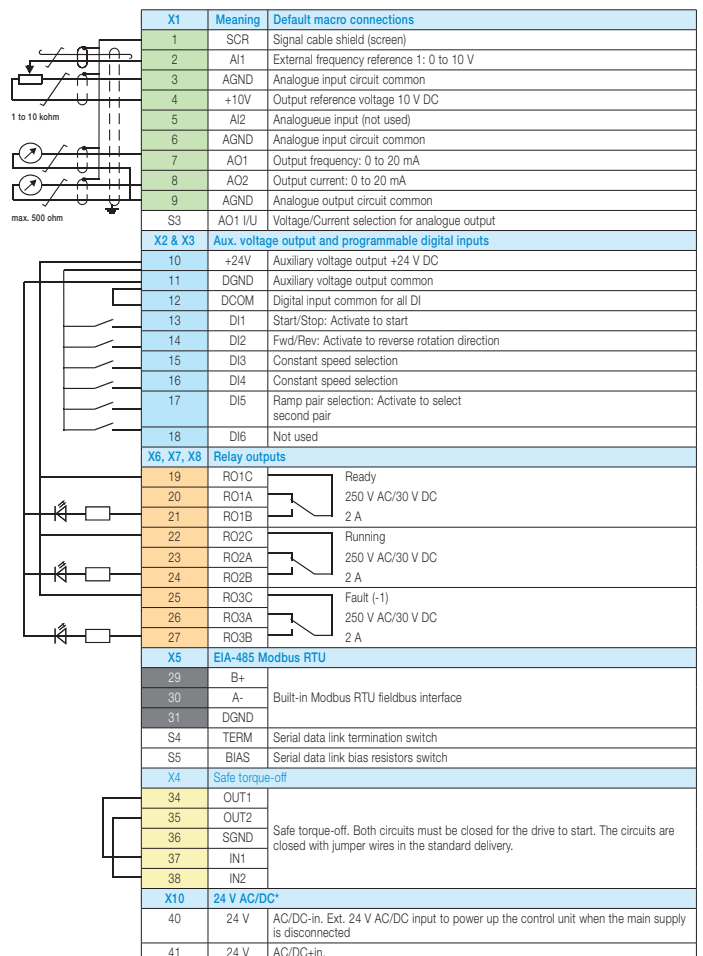

\*Standard on R6 frames and above and is optional on smaller frames (requires a CMOD)

# Low voltage AC drives

## ABB general purpose drive

ACS580 – Common user interfaces

### Control panel

State-of-the-art, high resolution keypad brings a new level of usability to the drives marketplace. The ACS580 uses the keypad platform from the new “all compatible” range of drives from ABB. The main difference, is that the ACS580 includes a “primary settings” menu, a guided set-up procedure similar to that of a smart phone, making it very easy to commission.

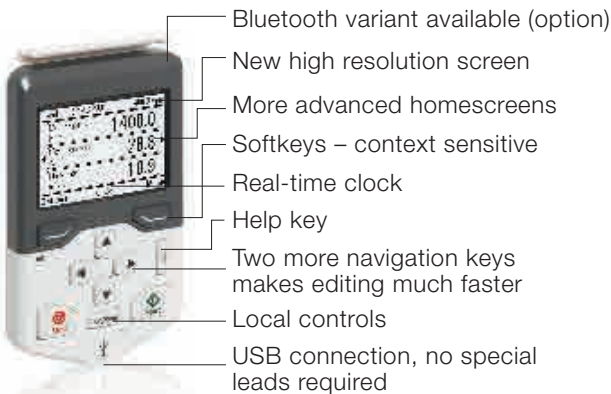

See page 65 for further keypad info

### Bluetooth keypad and DriveTune app

Using a special Bluetooth enabled keypad, ABB offers connection to a mobile phone using an app called DriveTune. There are versions of the app for IOS and Android operating systems.



### Fieldbus (various Plus codes)

The ACS580 supports an extensive list of fieldbus modules for connectivity to industrial networks. These modules are common with other drives within the ABB drives range. Modbus embedded as standard.



### I/O extension and external 24 V (+L501)

The CMOD-01 offer additional two relay outputs (changeover) and one digital output, as well as giving a place to connect external 24 V (AC or DC).



### Panel/keypad bus adapter - CDPI-01(+K450)

The ACS580 can be connected onto a panel bus, where 32 drives can be daisy chained using a simple CAT5 cable. The chain would have one keypad mounted on the cabinet door, communicating to the other drives via the CDPI module, which fits where the keypad normally connects on the drive.



### Interface

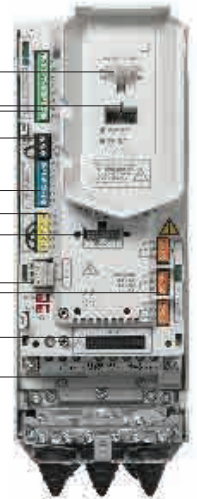
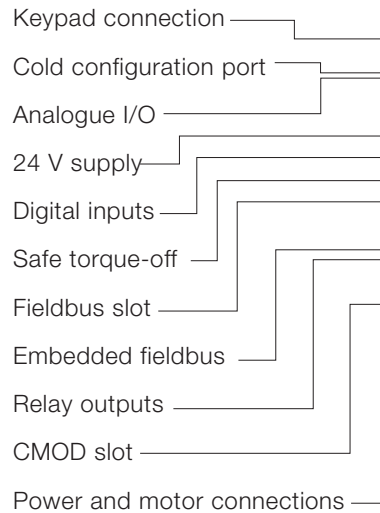

### Isolated PTC input and external 24 V (+L523 or L537)

The CMOD-02 offers an isolated PTC interface, as well as giving a place to connect external 24 V (AC or DC). The CPTC-02 offers isolated PTC with ATEX certification.



### High voltage I/O extension (+L512)

The CHDI-01 offers an additional six high voltage (115/230 V) digital inputs and two relay outputs (changeover); allows high voltage connection without interposing relays.

### Drive Composer PC tool

Drive Composer is the new PC tool for the ACS580 family. The PC tool comes in two variants – the “Entry” level is a free of charge point-to-point tool and allows simple parameter editing and storage, as well as monitoring and commissioning support, while the “Pro” level has all of this as well as animated control diagrams and extended commissioning, monitoring and diagnostic support, as well as the ability to program the safety functions. The Pro tool allows the user to connect to multiple drives either over “panel bus” where the keypad port is used, or ever Ethernet.



### Door mounting kit, DPMP-EXT (IP65)

The keypad can be mounted onto a panel door using a two part kit. The kit includes a CDPI which is mounted onto the drive, then the DPMP-02 (pictured) is mounted onto the door and a CAT5 cable is used to connect between the two. When keypad is installed the assembly is IP65.



# Low voltage AC drives

## ABB drive for HVAC

0.55 kW to 250 kW, ACH580

Motor control method - scalar, vector speed (open and closed loop)

380/480 V, 3-phase supply, 0.55 kW - 250 kW

### What is an ABB HVAC drive?

ACH580 is the new dedicated low voltage AC drive for heating, ventilation & air-conditioning (HVAC) applications. The drives are designed to meet - straight out of the box - the HVAC market requirements including harmonics and EMC standards and for easy integration with building management systems. HVAC features such as override functionality are enhanced to further make this drive an industry specialist. The new platform is able to accurately and properly control induction, permanent magnet and SynRM motors. With improved built-in PID control, native BACnet communication, timers, real-time clock and a calendar, ABB HVAC drives provide flexible solutions for a wide range of HVAC needs.

### Where can it be used?

ABB HVAC drives make maintaining a buildings comfort zone easy, quick and energy efficient. The drives control the speed of pump, fan and refrigeration compressor motors used in air handling units, cooling towers, chillers and other HVAC applications. They help reduce the HVAC system's energy consumption by up to 70 percent, and quite often have payback times of less than a year. These highly reliable drives with built-in BACnet easily integrate into building management systems.



### Highlights

- Built-in BACnet
- Accurate and efficient control of induction, permanent magnet and SynRM motors
- New energy monitoring features record energy, CO<sub>2</sub> and money saved (compared to equivalent DOL)
- Wide power range in wall-mounted IP21 and IP55 variants
- Intelligent HVAC control panel
- Assistant control panel with improved primary settings menu and backups, smartphone useability
- STO SIL3, PL e

Feature	Advantage	Benefit
Intuitive modern keypad	High contrast, high definition display giving intuitive access to the drive parameters. Built-in "Help" button, giving programming hints. Real-time clock, allows timed tracing of faults and setting of parameters to activate functions at various times of day	Easy commissioning, programming, maintenance and fault finding, making the drive easy to own and use across all activities
Primary settings menu	Assisted set-up for all of the drives common settings. Intuitive and context sensitive makes navigation easier for the user, like a smartphone	Even easier to configure the drive to the application. Next level of VSD usability
Swinging choke, improved	Patented by ABB Reduces the drives' harmonic signature, especially on partial loads. Improved with permanent magnet technology	Reduces part load harmonics by up to 25 percent, in comparison with traditional chokes. Variable air volume (VAV) systems run on partial loads at least 95 percent of the time
EMC (manufacturer's statement available)	Integrated category C2 (1st environment) filters to BS EN 61800-3	EMC filters suitable for 400 V network connection built-into the drive as standard will save panel space, avoid additional wiring, earthing and assembly costs
Advanced serial communications	HVAC protocols built-in as standard. BACnet, Modbus RTU embedded. Fieldbus adapters allow connection of: BACnet IP, Profibus-DP, CANopen, DeviceNet, Modbus/TCP, ControlNet, Ethernet	Can connect to any building management system (BMS), native BACnet as standard, Ethernet based BACnet as an option
Real-time clock	Easily set up at time of installation and protected by its own battery back-up. The time allows the drive to timestamp events and operate functions at set times, thus removing the need for external devices	Can be used together with timer functions of the drive to trigger various events (via relays or outputs) within the application software such as time / speed profile, allowing the drive to be a stand alone unit without the need for BMS input
System diagnostics	Diagnostic assistant, on-board fault history with real-time of when fault occurred, covering voltage, current, DC link level etc	Instant fault tracking and date stamping, gives status of drive to enable rapid drive diagnostics
Energy efficiency counters	Works out energy savings of the application in kWh and MWh; the cost of the energy saved in a local currency; and the carbon dioxide (CO <sub>2</sub> ) emissions equivalent of the energy saved	Can assist with electricity billing in accordance with Part L2 Building Regulations. Allows verification of energy savings before making investments in capital equipment

# Low voltage AC drives

## ABB drive for HVAC

ACH580 – Variants, ratings voltages and prices

The drive is programmed by the most intuitive and user friendly keypad ABB has produced and incorporates a “primary settings” menu that guides the user through the most common settings. The new PC tool is designed to incorporate all of the latest functionality that new operating systems bring, including a free of charge entry level version and a chargeable Pro version.

The drive retains the same swinging choke harmonic suppression technology, which has been updated to permanent magnet technology, making the package lighter. The IP rating has improved to IP55. Improvements are made to terminal sizes and fieldbus offerings, as well as being powered by an external 24 V.

Motor control has been vastly updated. The drive can control, induction, permanent magnet (PM) and SynRM motors. It can accurately catch spinning leads and ride through power dips.

The drive includes built-in machinery safety functionality with safe torque-off (STO) to SIL 3 PL e as standard. There are more frame sizes, extending the power range to 250 kW in a wall-mounted format and the IP55 variant is significantly smaller, occupying almost the same space as the IP21 equivalent.



For more details, please refer to Technical Catalogue 3AUA0000186691

### Wall-mounted single drive Series ACH580-01

- Wall-mounted or cabinet, frame sizes R1-R9
- Two variants, IP21 and IP55
- Built-in EMC filter (1st & 2nd environment)
- HVAC software, easy to configure
- Built-in BACnet and Modbus interfaces
- Cable connection box with SWA glanding
- Control of IM, PM and SynRM motors
- HVAC assistant control panel, NEW design
- Built-in patented swinging choke, improved
- Sensorless vector control, scalar control
- CCA-01 compatible, programming in the box
- RoHS compliant
- New rules for outdoor mounting available

### 380 – 480 V, 3-phase supply voltage (ratings shown are for 415 V)

No-overload (nominal) use		Light-duty use		Heavy-duty use		Max output A	Frame	Fuse A	Heat dissipation	Cooling requirements	Type (+J400 + H358 to order keypad & SWA gland plate)	Price IP21	Price IP55 (+B056)
$P_N$ kW	$I_N$ A	$P_{Ld}$ kW	$I_{Ld}$ A	$P_{hd}$ kW	$I_{hd}$ A			Type gG	W	m <sup>3</sup> /h			
0.75	2.6	0.75	2.5	0.55	1.8	3.2	R0	4	45	34	ACH580-01-02A6-4	£433	£520
1.1	3.3	1.1	3.1	0.75	2.6	4.7	R0	6	55	34	ACH580-01-03A3-4	£466	£531
1.5	4	1.5	3.8	1.1	3.3	5.9	R0	6	66	34	ACH580-01-04A0-4	£531	£606
2.2	5.6	2.2	5.3	1.5	4	7.2	R0	10	84	34	ACH580-01-05A6-4	£563	£682
3	7.2	3	6.8	2.2	5.6	10.1	R1	10	106	50	ACH580-01-07A2-4	£617	£736
4	9.4	4	8.9	3	7.2	13	R1	16	133	50	ACH580-01-09A4-4	£693	£855
5.5	12.6	5.5	12	4	9.4	14.1	R1	16	174	50	ACH580-01-12A6-4	£812	£920
7.5	17	7.5	16.2	5.5	12.6	22.7	R2	25	228	128	ACH580-01-017A-4	£952	£1,007
11	25	11	23.8	7.5	17	30.6	R2	32	322	128	ACH580-01-025A-4	£1,180	£1,331
15	32	15	30.4	11	24.6	44.3	R3	40	430	116	ACH580-01-032A-4	£1,515	£1,688
18.5	38	18.5	36.1	15	31.6	56.9	R3	50	525	116	ACH580-01-038A-4	£1,721	£1,894
22	45	22	42.8	18.5	37.7	67.9	R3	63	619	116	ACH580-01-045A-4	£1,969	£2,250
30	62	30	58	22	44.6	76	R4	80	835	134	ACH580-01-062A-4	£2,348	£2,694
37	73	37	68	30	61	104	R4	100	1024	134	ACH580-01-073A-4	£2,661	£3,018
45	88	45	82.7	37	72	122	R5	100	1240	139	ACH580-01-088A-4	£3,364	£3,699
55	106	55	100	45	87	148	R5	125	1510	139	ACH580-01-106A-4	£4,543	£5,268
75	145	75	138	55	105	178	R6	160	1476	435	ACH580-01-145A-4	£5,646	£6,598
90	189	90	161	75	145	247	R7	250	1976	450	ACH580-01-169A-4	£6,836	£7,755
110	206	110	196	90	169	287	R7	315	2346	550	ACH580-01-206A-4	£7,744	£8,556
132	246	132	234	110	206	350	R8	355	3336	550	ACH580-01-246A-4	£9,258	£10,188
160	293	160	278	132	246	418	R8	425	3936	1150	ACH580-01-293A-4	£12,139	£13,387
200	363	200	345	160	293	498	R9	500	4836	1150	ACH580-01-363A-4	£15,371	£16,188
250	430	200	400	200	363	617	R9	630	6036	1150	ACH580-01-430A-4	£18,899	£19,903

For 440 to 480 V data see the User's Manual, document code: 3AUA0000076333



# Low voltage AC drives

## ABB drive for HVAC

ACH580-01 – Dimensions and options

### Dimensions and weights, wall-mounted drives

IP21				
Frame size	Height mm	Width mm	Depth mm	Weight kg
R0	303	125	210	4.5
R1	303	125	223	4.6
R2	394	125	227	7.5
R3	454	203	228	14.9
R4	600	203	258	19
R5	732	203	283	23
R6	727	252	369	45
R7	880	284	370	55
R8	965	300	393	70
R9	955	380	418	98



IP55				
Frame size	Height mm	Width mm	Depth mm	Weight kg
R0	303	125	222	5.1
R1	303	125	233	5.1
R2	394	125	239	8.0
R3	454	203	237	15.4
R4	600	203	265	20
R5	732	203	320	29
R6	726	252	380	45.5
R7	880	284	381	55.5
R8	965	300	452	72
R9	955	380	477	100



### Options for ACH580-01

ACH580-01 is a wall mounted drive, so all of the options fit inside:

- IP55 variant
- Internal fieldbus options
- Optional additional industrial fieldbus
- Optional relay expansion
- Optional isolated PTC option
- Optional 115/230 V digital inputs
- UK gland box to accommodate SWA cable
- Brake chopper (up to frame R3 fitted as standard)

All ABB HVAC drives use the same common options and user interfaces. These are detailed on page 50. They are also part of the “all compatible family” so keypad interfaces, common PC tools, parameter structures and programming methods are all common.

### Cold configuration adapter – CCA-01

ACH580 drives can be programmed without the need for mains power or without taking the drive out of the box using the CCA-01. This specifically allows rapid programming for OEM without the need for safe areas in production.



### Typical I/O connections for ACH580

These connections are shown as examples only. Please refer to the User's Manual – macro section, for more detailed information and for different I/O configurations.

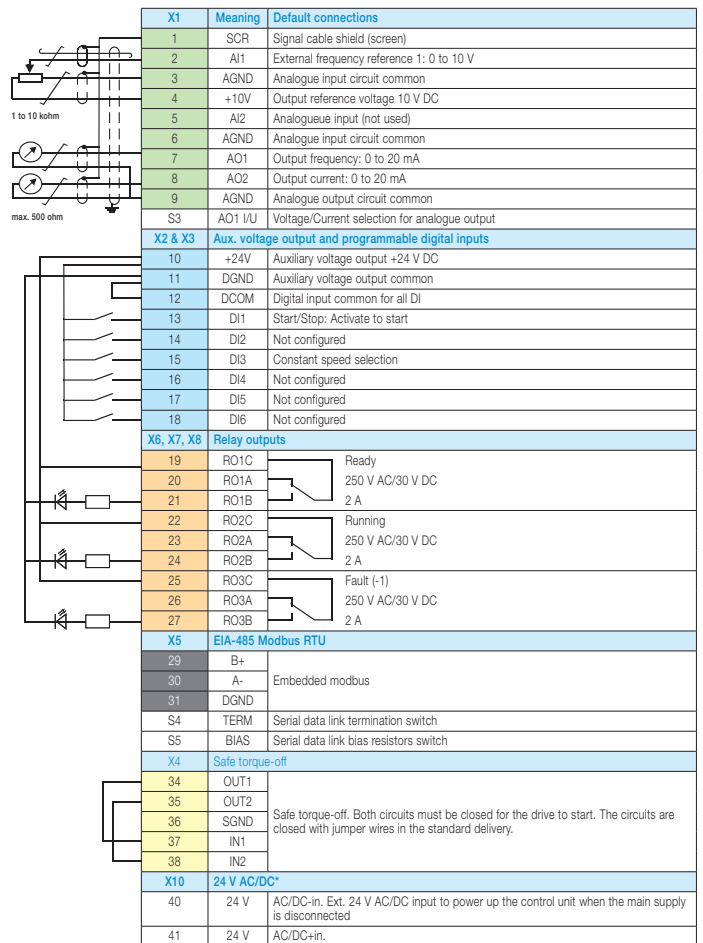

\*Standard on R6 frames and above and is optional on smaller frames (requires a CMOD)

# Low voltage AC drives

## ABB drive for HVAC

ACH580 – Common user interfaces

### Control panel

State-of-the-art high resolution keypad brings a new level of usability to the drives marketplace. The ACH580 uses a HVAC specific keypad with hand/off/auto buttons. The ACH580 includes a “primary settings” menu that is suited to HVAC users, a guided set-up procedure similar to that of a smart phone.

4

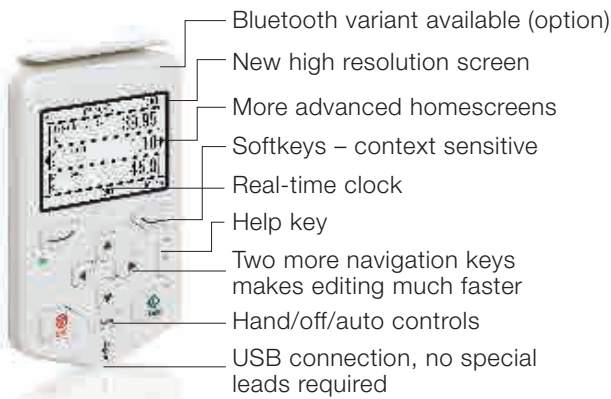

### Bluetooth keypad and DriveTune app

Using a special Bluetooth enabled keypad, ABB can offer connection to the mobile phone using an app called DriveTune. There are versions of the app for IOS and Android operating systems.



### I/O extension and external 24 V (+L501)

The CMOD-01 offer additional two relay outputs (changeover) and one digital output, as well as giving a place to connect external 24 V (AC or DC).



### Fieldbus (various Plus codes)

The ACH580 supports an extensive list of fieldbus modules including BACnet IP, for connectivity to industrial networks. These modules are common with other drives within the ABB drives range.



### Panel/keypad bus adapter - CDPI-01(+K450)

The ACH580 can be connected onto a panel bus, where 32 drives can be daisy chained using a simple CAT5 cable. The chain would have one keypad mounted on the cabinet door, communicating to the other drives via the CDPI module, which fits where the keypad normally connects on the drive.



### Interface

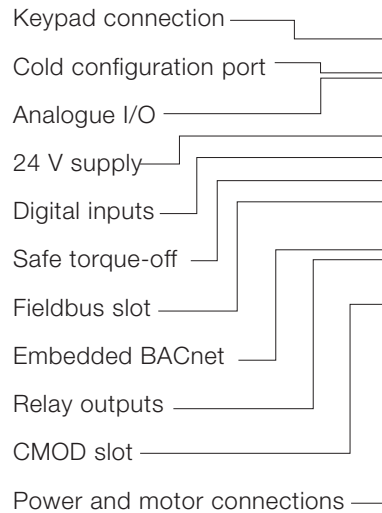

### Isolated PTC input and external 24 V (+L523)

The CMOD-02 offers an isolated PTC interface, as well as giving a place to connect external 24 V (AC or DC)



### High voltage I/O extension (+L512)

The CHDI-01 offers an additional six high voltage (115/230 V) digital inputs and two relay outputs (changeover); allows high voltage connection without interposing relays.

### Drive Composer PC tool

Drive Composer is the new PC tool for the ACH580 family. The PC tool comes in two variants – the “Entry” level is a free of charge point-to-point tool and allows simple parameter editing and storage, as well as monitoring and commissioning support, while the “Pro” level has all of this as well as animated control diagrams and extended commissioning, monitoring and diagnostic support, as well as the ability to program the safety functions. The Pro tool allows the user to connect to multiple drives either over “panel bus” where the keypad port is used, or over Ethernet.



### Door mounting kit, DPMP-EXT (IP65)

The keypad can be mounted onto a panel door using a two part kit. The kit includes a CDPI which is mounted onto the drive, then the DPMP-02 (pictured) is mounted onto the door and a CAT5 cable is used to connect between the two. When keypad is installed the assembly is IP65.



# Low voltage AC drives

## ABB drive for water and wastewater

0.75 kW to 250 kW, ACQ580

Motor control method – Scalar, vector speed and torque (open and closed loop)

380-480 V, 3-phase supply, 0.75 kW - 250 kW

What is the next generation ABB drive for water and wastewater?

This new industry-specific drive is part of the ABB all compatible platform, and allows smooth control of induction, permanent magnet and SynRM motors. The modules feature tailor-made pump control functions for single and multipump systems that ensure smooth, disturbance-free operation, maximised energy efficiency and reduced downtime.

### Highlights

- Intelligent solution for controlling pump performance
- Remote monitoring and diagnostics
- Pump cleaning/de-ragging algorithms
- Full multipump software including auto charge
- Easy and cost-effective cabinet assembly
- Improved internal options, including external 24 V support
- Assistant control panel with intelligent primary settings menu and backups
- SynRM, permanent magnet and induction motor control with improved motor platform



For further information, see Technical Catalogue 3AUA0000194172

Where can it be used?

The drive can be used for any of the variable-speed applications contained within the water and wastewater industry, to optimise the system and to save energy. Wall or cabinet assembly, the drives are easily mounted side-by-side. Highly intuitive primary settings menus allows the drive to be configured like a smart phone and coupled with intelligent start-up assistant ensures that drive commissioning is straightforward. The functions needed for most pumping systems can be easily implemented using the primary settings applications. Starting up a pumping system and optimising its performance is now even easier.

Feature	Advantage	Benefit
Pump cleaning or de-ragging	Used in wastewater pumping stations to prevent pump and pipe clogging and expensive maintenance activities	Triggers against different commands e.g on each pump start; on monitoring if the pump is becoming blocked; in response to a digital input or PLC command
Multi-pump control	Optimal control of applications where several parallel pumps are operated together and the required flow rate is variable	Maintains stable process conditions optimising the speed and number of the pumps needed without over-riding controller
Pump priority	Optimal control of applications where the consumption rate varies based on demand	Operate higher capacity pumps during daytime and smaller units at night. This allows pumps to be operated closer to their best efficiency point
Quick ramps	Drive has special high speed ramps to quickly accelerate bore hole pumps and submersible pumps to operating speed	Allows the pump to operate properly, ensuring the bearings operate properly and reduces turbidity during start-up
Safe torque-off	TUV certified safely to SIL3	Remove the contactor from MCC builds, saving cost
Intuitive modern keypad	High contrast, high definition display giving intuitive access to the drive parameters. Built-in "Help" button, giving programming hints. Real-time clock, allows timed tracing of faults and setting of parameters to activate functions at various times of day. Changed parameters menu also included, so you can see your edits	Easy commissioning, programming, maintenance and fault finding, making the drive easy to own and use across all activities. Cloning drives is easy with parameter copying facilities
Primary setting menu	Assisted set-up for all of the drives common settings. Intuitive and context sensitive makes navigation easier for the user	Even easier to configure the drive to the application
Text editing capabilities	Rename drive variables or warning messages	Tailor the drive to "speak" in the language of the application
Improved backups	Keypad can store backups with a time stamp, or automatic backups can be taken. Backups can be viewed before download, or partial downloads can be performed	Easy to manage installed base and speeds up commissioning. Auto backup means you never forget
Modern PC tools	Entry level (FOC) and Pro level PC tools are available for commissioning, tuning, parameter management and monitoring	Keep copies of the parameters for back-up. Use the PC tools to optimise the application
Fieldbus gateways	Built-in Modbus using RS 485. Extensive optional plug-in fieldbus modules also available	Reduced cost, full access to industrial networks for monitoring and control
Energy monitoring and optimising features	Drive controls the motor voltage dependant on the load. Drive monitors the saved energy compared to equivalent DOL operation	Consumed energy optimised across the speed and load range. Energy savings presented in local currency and tonnes of CO <sub>2</sub>
24V operation	Power the drive control card, I/O and fieldbus from an external 24V	Safer diagnostics and maintenance activities can be undertaken without the need for mains voltages

# Low voltage AC drives

## ABB drive for water and wastewater

ACQ580 – Variants, ratings voltages and prices

The drive features, specific to water and wastewater applications, are programmed by the most intuitive and user friendly keypad ABB has produced and incorporates an intelligent “primary settings” menu that guides the user through the most common settings.

The drive includes a built in swinging choke harmonic suppression technology as standard, which uses permanent magnet technology, making the package lighter. The drive can control induction, permanent magnet (PM) and SynRM motors. It can accurately catch spinning leads and ride through power dips.

There are more frame sizes, extending the power range to 250 kW in a wall-mounted format and the IP55 variant is extremely compact occupying almost the same space as the IP21 equivalent.

The new PC tool is designed to incorporate all of the latest functionality that new operating systems bring, including a free of charge entry level version and a chargeable Pro version.



For more details, please refer to Technical Catalogue 3AXD5000035866A

### Wall-mounted single drive Series ACQ580-01

- Wall-mounted or cabinet, frame sizes R1-R9
- Two variants, IP21 and IP55
- Built-in EMC filter (1st environment)
- Water and wastewater software, easy to configure
- Multipump control of pump system
- Built-in Modbus interface
- Cable connection box with SWA glanding
- Control of IM, PM and SynRM motors
- Assistant control panel, NEW design
- Built-in patented swinging choke
- Sensorless vector control, scalar control
- RoHS compliant
- Safe torque off to SIL3 PLe as standard

### 380 – 480 V, 3-phase supply voltage (ratings shown are for 415 V)

No-overload (nominal) use		Light-duty use		Heavy-duty use		Max output A	Frame	Fuse A		Heat dissipation	Cooling requirements	Type (+J400 + H358 to order keypad & SWA gland plate)	Price IP21	Price IP55 (+B056)
P <sub>N</sub> kW	I <sub>N</sub> A	P <sub>Ld</sub> kW	I <sub>Ld</sub> A	P <sub>hd</sub> kW	I <sub>hd</sub> A			Type gG	W					
0.75	2.6	0.75	2.5	0.55	1.8	3.2	R0	4	45	34	34	ACQ580-01-02A6-4		
1.1	3.3	1.1	3.1	0.75	2.6	4.7	R0	6	55	34	34	ACQ580-01-03A3-4		
1.5	4	1.5	3.8	1.1	3.3	5.9	R0	6	66	34	34	ACQ580-01-04A0-4		
2.2	5.6	2.2	5.3	1.5	4	7.2	R0	10	84	34	34	ACQ580-01-05A6-4		
3	7.2	3	6.8	2.2	5.6	10.1	R1	10	106	50	50	ACQ580-01-07A2-4		
4	9.4	4	8.9	3	7.2	13	R1	16	133	50	50	ACQ580-01-09A4-4		
5.5	12.6	5.5	12	4	9.4	14.1	R1	16	174	50	50	ACQ580-01-12A6-4		
7.5	17	7.5	16.2	5.5	12.6	22.7	R2	25	228	128	128	ACQ580-01-017A-4	For prices on industry specific products please contact ABB's water and wastewater team	For prices on industry specific products please contact ABB's water and wastewater team
11	25	11	23.8	7.5	17	30.6	R2	32	322	128	128	ACQ580-01-025A-4		
15	32	15	30.4	11	24.6	44.3	R3	40	430	116	116	ACQ580-01-032A-4		
18.5	38	18.5	36.1	15	31.6	56.9	R3	50	525	116	116	ACQ580-01-038A-4		
22	45	22	42.8	18.5	37.7	67.9	R3	63	619	116	116	ACQ580-01-045A-4		
30	62	30	58	22	44.6	76	R4	80	835	134	134	ACQ580-01-062A-4		
37	73	37	68	30	61	104	R4	100	1024	134	134	ACQ580-01-073A-4		
45	88	45	82.7	37	72	122	R5	100	1240	139	139	ACQ580-01-088A-4		
55	106	55	100	45	87	148	R5	125	1510	139	139	ACQ580-01-106A-4		
75	145	75	138	55	105	178	R6	160	1476	435	435	ACQ580-01-145A-4		
90	189	90	161	75	145	247	R7	250	1976	450	450	ACQ580-01-169A-4		
110	206	110	196	90	169	287	R7	315	2346	550	550	ACQ580-01-206A-4		
132	246	132	234	110	206	350	R8	355	3336	550	550	ACQ580-01-246A-4		
160	293	160	278	132	246	418	R8	425	3936	1150	1150	ACQ580-01-293A-4		
200	363	200	345	160	293	498	R9	500	4836	1150	1150	ACQ580-01-363A-4		
250	430	200	400	200	363	617	R9	630	6036	1150	1150	ACQ580-01-430A-4		

For 440 to 480 V data see the User's Manual, document code: 3AXD5000035866A

# Low voltage AC drives

## ABB drive for water and wastewater

ACQ580-01 – Dimensions and options

### Dimensions and weights, wall-mounted drives

IP21				
Frame size	Height mm	Width mm	Depth mm	Weight kg
R0	303	125	210	4.5
R1	303	125	223	4.6
R2	394	125	227	7.5
R3	454	203	228	14.9
R4	600	203	258	19
R5	732	203	283	23
R6	727	252	369	45
R7	880	284	370	55
R8	965	300	393	70
R9	955	380	418	98



IP21

IP55				
Frame size	Height mm	Width mm	Depth mm	Weight kg
R0	303	125	222	5.1
R1	303	125	233	5.1
R2	394	125	239	8.0
R3	454	203	237	15.4
R4	600	203	265	20
R5	732	203	320	29
R6	726	252	380	45.5
R7	880	284	381	55.5
R8	965	300	452	72
R9	955	380	477	100



IP55

### Options for ACQ580-01

ACQ580-01 is a wall mounted drive, so all of the options fit inside:

- IP55 variant
- Internal fieldbus options
- Optional additional industrial fieldbus
- Optional relay expansion (CMOD-01)
- Optional isolated PTC option (CMOD-02)
- Optional 115/230 V digital inputs (CHDI-01)
- UK gland box to accommodate SWA cable
- Brake chopper (up to frame R3 fitted as standard)

All ABB water and wastewater drives use the same common options and user interfaces. These are detailed on page 54. They are also part of the “all compatible family” so keypad interfaces, PC tools, parameter structures and programming methods are all common.

### Cold configuration adapter – CCA-01

ACH580 drives can be programmed without the need for mains power or without taking the drive out of the box using the CCA-01. This specifically allows rapid programming for OEM without the need for safe areas in production.



### Typical I/O connections for ACQ580

These connections are shown as examples only. Please refer to the User's Manual for more detailed information and for different I/O configurations.

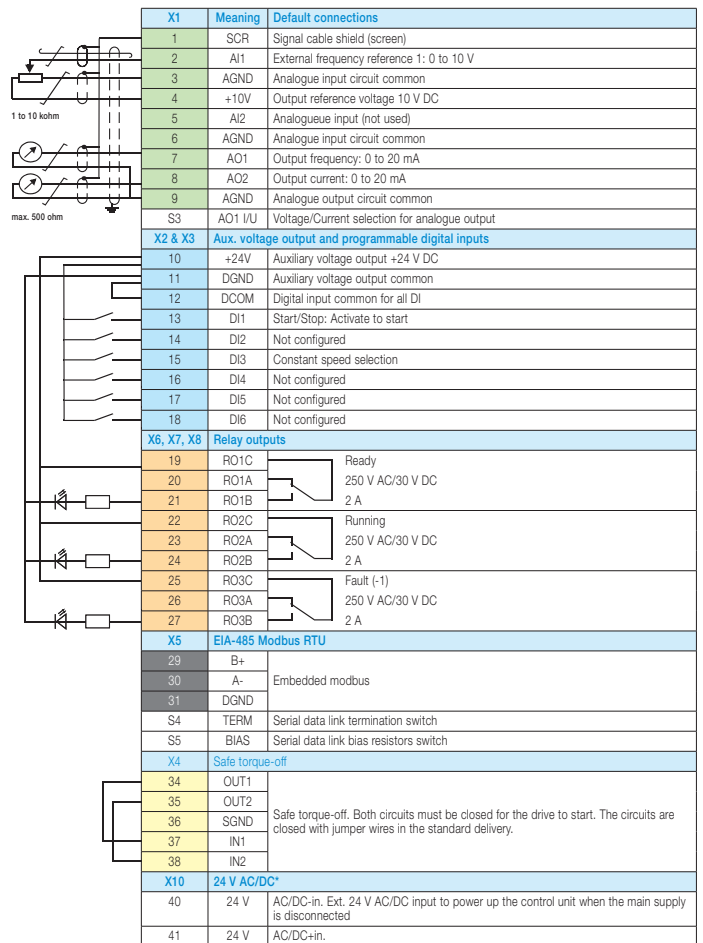

\*Standard on R6 frames and above and is optional on smaller frames (requires a CMOD)

# Low voltage AC drives

## ABB drive for water and wastewater

ACQ580 – Common user interfaces

### Control panel

State-of-the-art high resolution keypad brings a new level of usability to the drives marketplace. The ACQ580 uses a specific keypad with hand/off/auto buttons. The ACQ580 includes a “primary settings” menu that is suited to water and wastewater industry users, a guided set-up procedure similar to that of a smart phone.

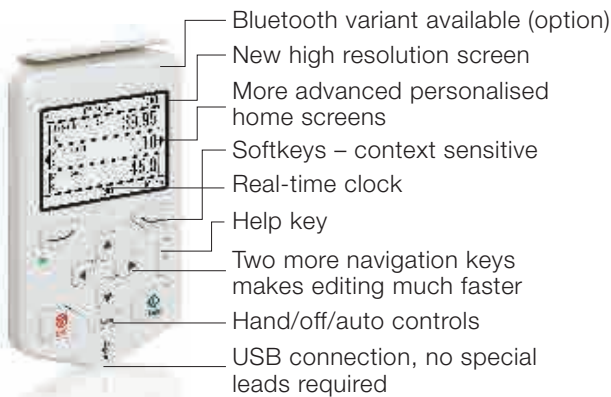

### Bluetooth keypad and DriveTune app

Using a special Bluetooth enabled keypad, ABB can offer connection to the mobile phone using an app called DriveTune. There are versions of the app for IOS and Android operating systems.



### I/O extension and external 24 V (+L501)

The CMOD-01 offer additional two relay outputs (changeover) and one digital output, as well as giving a place to connect external 24 V (AC or DC).



### Fieldbus (various and codes)

The ACQ580 supports an extensive list of fieldbus modules including Profibus, Ethernet IP and Devicenet for connectivity to industrial networks. These modules are common with other drives within the ABB drives range.



### Panel/keypad bus adapter - CDPI-01(+K450)

The ACQ580 can be connected onto a panel bus, where 32 drives can be daisy chained using a simple CAT5 cable. The chain would have one keypad mounted on the cabinet door, communicating to the other drives via the CDPI module, which fits where the keypad normally connects on the drive.



### Interface

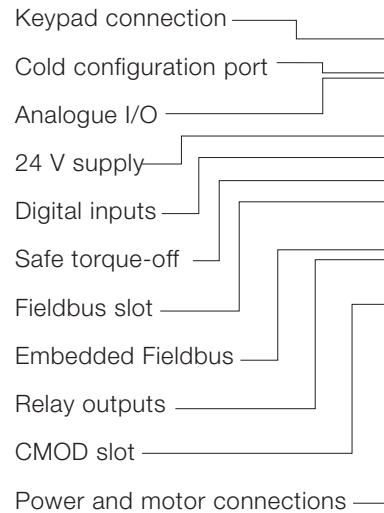

### Isolated PTC input and external 24 V (+L523)

The CMOD-02 offers an isolated PTC interface, as well as giving a place to connect external 24 V (AC or DC)



### High voltage I/O extension (+L512)

The CHDI-01 offers an additional six high voltage (115/230 V) digital inputs and two relay outputs (changeover); allows high voltage connection without interposing relays.

### Drive Composer PC tool

Drive Composer is the new PC tool for the ACQ580 family. The PC tool comes in two variants – the “Entry” level is a free of charge point-to-point tool and allows simple parameter editing and storage, as well as monitoring and commissioning support, while the “Pro” level has all of this as well as animated control diagrams and extended commissioning, monitoring and diagnostic support, as well as the ability to program the safety functions. The Pro tool allows the user to connect to multiple drives either over “panel bus” where the keypad port is used, or over Ethernet.



### Door mounting kit, DPMP-EXT, (IP65)

The keypad can be mounted onto a panel door using a two part kit. The kit includes a CDPI-01 which is mounted onto the drive, then the DPMP-02 (pictured) is mounted onto the door and a CAT5 cable is used to connect between the two. When keypad is installed the assembly is IP65.



# Low voltage AC drives

## ABB drive for water and wastewater



0.37 kW to 500 kW, ACQ810

Motor control method – DTC

200/480 V, 3-phase supply, 0.37 kW - 500 kW

### What is an ABB drive for water and wastewater?

This industry-specific drive is designed for all of the applications commonly used in the water and wastewater industry. The modules feature tailor-made pump control functions for single and multi-pump systems. These functions ensure smooth, disturbance-free operation of water and wastewater processes, maximising energy efficiency while reducing unnecessary downtime. The drives' pump-specific functions decrease the life cycle cost of the pumping system, helping to save time and money. The power range is extended with the introduction of the G1 and G2 frame sizes.

### Highlights

- Optimal pump control for various applications
- Intelligent solution for controlling pump performance
- Remote monitoring and diagnostics
- Pump auto change
- Full multipump software functionality
- Flow measurement feature suitable, ideal for leak detection
- Anti-jam pump cleaning algorithms
- Easy and cost-effective cabinet assembly



For further information, see Technical Catalogue 3AUA0000055685

### Where can it be used?

The ABB industry-specific drive module can be used for the variable-speed applications contained within the water and wastewater industry, to optimise the system and to save energy. The modules are designed for cabinet assembly and are easily mounted side-by-side. Intelligent start-up assistant ensures that drive commissioning is straightforward. The functions needed for most pumping systems can be easily implemented with the pre-programmed macros. Starting up a pumping system and optimising its performance is extremely easy.

Feature	Advantage	Benefit
Direct torque control	Premium motor control platform	Lower losses, improved energy saving
Soft pipe filling	Provides a pump with a smooth build-up of flow and pressure in pipes	This avoids pressure peaks and reduces the stresses on weak or ageing water mains when demand changes
Pump cleaning or anti-jam	Used in wastewater pumping stations to prevent pump and pipe clogging and expensive maintenance activities	The function can be set to trigger against different commands e.g on each pump start; on monitoring if the pump is becoming blocked; in response to a digital input or PLC command. If the pump cleaning function runs too often, an alarm is raised. Benefits: reduced downtime, increased efficiency
Flow calculation	The drive has a flow meter routine that very accurately determines the flow rate within a process	Avoids the need for costly external flow meters and is suitable for applications where the flow data is not needed for invoicing purposes
Level control	Used to effectively control the filling or emptying of water or wastewater storage tanks	Fast-ramp starting creates a flush effect to keep pipes clear. Users can define the "efficiency speed" based on the pumps best efficiency point
Multi-pump control	Optimal control of applications where several parallel pumps are operated together and the required flow rate is variable	Maintains stable process conditions optimising the speed and number of the pumps needed without over-riding controller
Pump priority	Optimal control of applications where the consumption rate varies based on demand	Operate higher capacity pumps during daytime and smaller units at night. This allows pumps to be operated closer to their best efficiency point
Pump specific protection features	The protection functions indicate if the pre-defined process conditions change	Underload and overload functions are pre-defined across the speed range at five distinct points. Belt breaks or dry sumps can be detected
Safe torque-off	TUV certified safely to SIL3	Remove the contactor from MCC builds, saving cost

# Low voltage AC drives

## ABB industrial drive



0.55 kW to 5600 kW, ACS880

Motor control method – DTC or scalar

208 / 240 V, 3-phase supply, powers dependent on range

380 / 415 V, 3-phase supply, powers dependent on range

380 / 500 V, 3-phase supply, powers dependent on range

525 / 690 V, 3-phase supply, powers dependent on range

What is the ABB industrial drive?

The ACS880 is a build to order, custom configurable drive encompassing a wide power range with a choice of rectifiers and build formats, the most comprehensive industrial drive on the market. The ACS880 contains a new harmonised parameter set, taking its features from all of the best functions within the existing ABB drive's family. The drive is programmed by ABB's most intuitive and user-friendly keypad yet. A new PC tool incorporates all of the latest functionality including a free-of-charge entry level version and a professional level version. The drive also contains the latest 4th generation DTC motor control core, making the drive all-compatible with any motor available on the market including asynchronous (induction), permanent magnet and synchronous reluctance (SynRM) motors.

Where can it be used?

The ABB industrial drive is targeted at demanding industrial applications offering constant torque and torque at zero speed. Suitable applications include cranes, winders, hoists, extruders, heavy conveyors and crushers. Applications with high breakaway torque, like rubber mixers and high precision applications like paper machines and engine dynamometers are easily handled by the drive.

The ACS880 is a system drive that is fully scaleable and can be tailored to any application, allowing architecture to be either centralised (traditional PLC approach) or de-centralised, by operating the safety and the application programmes inside the drive, which saves installation and cabling costs.

### Highlights

- Built-to-order and customisable
- Wide power range and choice of rectifiers, modules, cabinets or multidrives
- Marine certified
- Built-in safety functionality to IEC 62061 and ISO 13849-1
- Removable memory unit providing zero re-commissioning
- Adaptive programming as standard, full IEC61131 (CODESYS) as an option
- Common user and process interface with fieldbus
- Common software tools for sizing and commissioning
- Innovative hardware variants including modular and cabinet installation kits
- Energy efficiency counters and energy optimiser
- Load analyser for optimised dimensioning of the drive, motor and process





# Low voltage AC drives

## ABB industrial drive

Feature	Advantage	Benefit
Fully customisable built-to-order	Drive can be ordered and built to the exact requirements of the customer. Wall mount, cabinet built, module kits, multidrives, all formats available. The formats can include 6- and 12-pulse, regenerative or ultra low harmonic rectifiers. Global certifications	The drive can arrive in exactly the format required by the application; including HW variants, built-in safety and PLC programme all in one package
Direct torque control (DTC)	Full torque at zero speed without encoder Accurate speed and torque control	Consistently excellent performance ensures that drive is not the limiting factor in the process
Control all motor types	Induction motor, permanent magnet motor and SynRM control all possible with the same drive	High quality control allows simpler selection and easy upgrades in the future
Intuitive modern keypad	High contrast, high definition display giving intuitive access to the drive parameters	Easy commissioning, programming, maintenance and fault finding
Start-up assistant	Guides user through all essential settings without going to parameter list	Easy set-up of parameters, your own language, on-line information system always available
Removable memory unit	Programme, parameter edits, motor calibrations and fault histories stored in the removable memory unit	Zero re-commissioning in case of drive failure, just move the memory unit, very short MTTT
Safe torque-off (STO)	Standard feature always in the drive. SIL3 PLc, TÜV approved	Convenient safety built-in. ATEX approved for hazardous areas
Adaptive programming	Drive contains a freely programmable environment allowing changes and adaptations to the drive parameters. Easy to use and flexible	The drive can easily be flexed to meet the needs of the application, without external devices, existing controls, timers, relays etc
IEC61131 programming (CODESYS)	Familiar PLC programming on the drive de-centralise the application, import from other devices	Decide to have distributed or central control of your process. Program can copy from PLC to drive using same tool
Integrated, patented, TÜV approved safety module option	No need to use external programmable safety hardware for drive specific functions. The module carries out drive specific safety functionality more efficiently than external programmable devices, as they are designed to work directly with the drive. Patented safety monitoring functions allow the drive to undertake speed related safety functions with no additional speed feedback devices needed	Minimise installation time and space. Shorter design times using TÜV approved module. Drive specific safety functions save time and money as they are built-in, and do not require additional speed monitoring devices to operate
Modern PC tools; DriveComposer	Entry level free-of-charge and Pro level PC tools are available for commissioning, tuning, parameter management and monitoring	Keep copies of the parameters for back-up. Use the PC tools to optimise the application
Fieldbus gateway I/O extension modules	Snap-on module that is easily mounted inside drive Additional I/O can be added to the drive	Access to all major automation platforms Easy addition of extra I/O to allow the drive to control the application properly
Speed feedback modules	A large array or high performance speed feedback devices can be interfaced to the drive via these modules	Higher performances can be achieved or position control can be undertaken
Energy monitoring and optimising features	Drive controls the motor voltage dependant on the load. Drive monitors the saved energy compared to equivalent DOL operation	Consumed energy optimised across the speed and load range. Energy savings presented in local currency and tonnes of CO <sub>2</sub>
Drive-to-drive link	Built-in industrial control link	Built-in ability to undertake master-follower applications with no extra hardware
ATEX approved packages	ATEX 2014/34/EU type tested motor/drive packages from one supplier. ATEX STO and ATEX PTC connections	Easy selection of fully approved ATEX drive and motor packages, easier to satisfy ATEX rules with a more cost effective offering
Specific firmware for applications	Crane, winch, winder etc. ABB designed and verified firmware sets ready made and documented	Quick realisation of complex applications using ABB expertise, faster and cheaper engineering



# Low voltage AC drives ABB industrial drive



ACS880-01 - Variants, ratings, types, voltages and prices

## Wall-mounted single drive

- 0.55 kW to 250 kW, (208 - 690 V)
- Largest power wall-mounted drive on market
- Coated boards as standard
- TÜV approved safe torque-off (STO) to SIL 3 PL e standard
- IP21 as standard, IP55 as option
- IP55 variant same footprint as IP21 variant
- Brake chopper standard to R4 frame, option thereafter
- Wide range of built-in options
- EMC filter for C3 category according to EN 61800-3 (2004) standard (category C2 optional)
- Optional UK cable box for SWA cables
- Optional internal fieldbus
- Optional safety module for extended safety functionality
- Optional I/O expansion
- Optional IEC61131 programming (CODESYS), full system capability



For further information, see Technical Catalogue 3AUA0000098111

## 380 to 415 V, 3-phase supply voltage. The power ratings are valid at nominal voltage (400 V)

No-overload (nominal) use		Light-duty use		Heavy-duty use		Max output A	Frame	Fuse A	Heat dissipation	Cooling requirements	Type (+ E200, + R700 + H358 to order EMC & SWA gland plate)	Price IP21	Price IP55 (+B056)
P <sub>n</sub> kW	I <sub>n</sub> A	P <sub>Ld</sub> kW	I <sub>Ld</sub> A	P <sub>hd</sub> kW	I <sub>hd</sub> A								
0.75	2.4	0.75	2.3	0.55	1.8	3.1	R1	4	30	44	ACS880-01-02A4-3	£909	£947
1.1	3.3	1.1	3.1	0.75	2.4	4.1	R1	6	40	44	ACS880-01-03A3-3	£951	£991
1.5	4.0	1.5	3.8	1.1	3.3	5.6	R1	6	52	44	ACS880-01-04A0-3	£983	£1,024
2.2	5.6	2.2	5.3	1.5	4.0	6.8	R1	10	73	44	ACS880-01-05A6-3	£1,121	£1,165
3	8	3	6.8	2.2	5.6	9.5	R1	10	94	44	ACS880-01-07A2-3	£1,185	£1,232
4	10	4	8.9	3	7.2	12.2	R1	16	122	44	ACS880-01-09A4-3	£1,323	£1,374
5.5	12.9	5.5	12	4	9.4	16	R1	16	172	44	ACS880-01-12A6-3	£1,577	£1,632
7.5	17	7.5	16	5.5	12.6	21	R2	25	232	88	ACS880-01-017A-3	£1,671	£1,732
11	25	11	24	7.5	17	29	R2	32	337	88	ACS880-01-025A-3	£2,127	£2,200
15	32	15	30	11	25	42	R3	40	457	134	ACS880-01-032A-3	£2,434	£2,518
18.5	38	18.5	36	15	32	54	R3	50	562	134	ACS880-01-038A-3	£2,604	£2,699
22	45	22	43	19	38	64	R4	63	667	200	ACS880-01-045A-3	£2,960	£3,072
30	61	30	58	22	45	76	R4	80	907	200	ACS880-01-061A-3	£3,501	£3,634
37	72	37	68	30	61	104	R5	100	1117	280	ACS880-01-072A-3	£3,950	£4,105
45	87	45	83	37	72	122	R5	100	1120	280	ACS880-01-087A-3	£4,787	£4,964
55	105	55	100	45	87	148	R6	125	1295	435	ACS880-01-105A-3	£5,106	£5,304
75	145	75	138	55	105	178	R6	160	1440	435	ACS880-01-145A-3	£5,657	£5,886
90	169	90	161	75	145	247	R7	^ 315	1940	450	ACS880-01-169A-3	£7,452	£7,744
110	206	110	196	90	169	287	R7	^ 315	2310	450	ACS880-01-206A-3	£8,662	£9,023
132	246	132	234	110	206	350	R8	^ 350	3300	550	ACS880-01-246A-3	£10,583	£11,047
160	293	160	278	132	246*	418	R8	^ 400	3900	550	ACS880-01-293A-3	£12,238	£12,784
200	363	200	345	160	293	498	R9	^ 550	4800	1150	ACS880-01-363A-3	£15,108	£15,771
250	430	250	400	200	363**	545	R9	^ 630	6000	1150	ACS880-01-430A-3	£18,385	£19,131

\*130% overload, \*\*125% overload

† For fuse selection, refer to the hardware manual. Weak networks may require aR fuses

^ These fuses are aR fuses, ABB does not recommend gG fuses on these larger drives

Note: Current rating match IE3 motor nameplates

Note: Prices include keypad, EMC filter and SWA gland plates and full manuals

# Low voltage AC drives

## ABB industrial drive

ACS880-01 – Dimensions and options



### Drive dimensions and weights wall mounted drives

Frame size	Height <sup>1</sup> IP21 mm	Depth <sup>2</sup> IP21 mm	Width mm	Depth mm	Weight kg
R1	405	370	155	226	6
R2	405	370	155	249	8
R3	471	420	172	261	10
R4	573	490	203	274	18.5
R5	730	596	203	274	23
R6	726	569	251	357	45
R7	880	600	284	365	55
R8	963	681	300	386	70
R9	955	680	380	413	98

H1 - Height with cable entry box  
H2 - Height without cable entry box  
Width and depth with cable entry box



4

Frame size	Height <sup>1</sup> IP55 mm	Width mm	Depth mm	Weight kg
R1	450	162	295	6
R2	450	162	315	8
R3	525	180	327	10
R4	576	203	344	18.5
R5	730	203	344	23
R6	726	251	421	45
R7	880	284	423	55
R8	963	300	452	72
R9	955	380	477	100

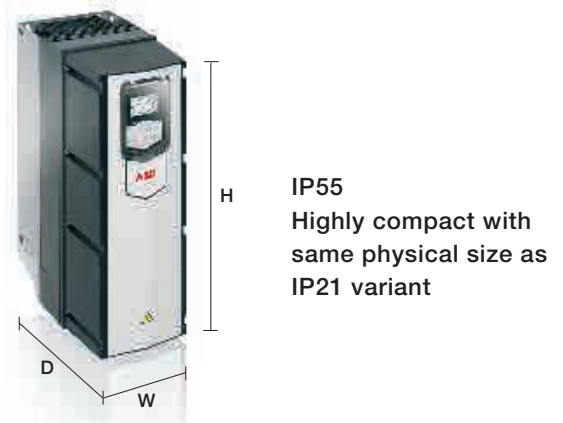

### Options

ACS880-01 is a wall-mounted drive, so all of the options fit inside:

- IP55 variant
- Can be ordered without covers for cabinet installation
- Extensive range of expansion I/O options
- Extensive range of motor feedback devices
- Extensive range of fieldbus options
- IEC61131 (CODESYS) environment
- Built-in safety option module, TÜV approved
- UK gland box to accommodate SWA cable
- Different levels of EMC compliance
- Extended warranty
- ATEX compliant options

All ABB industrial drives use the same common options and user interfaces. These are detailed on page 65.

- The IP55 variant is designed to occupy the same physical space as the IP21 unit, thus minimising wall space required to support this module.
- The drive has three slots for I/O and fieldbus expansion and one drive-to-drive serial communication link.

- I/O modules can be chosen from analogue expansion, digital expansion, encoder and resolver feedback options
- Fieldbus modules can be connected to any slot and all of the major industrial fieldbus modules are available. The drive also supports two fieldbus modules at a time, so can control via a traditional industrial fieldbus, but data gather via an Ethernet based protocol
- Remote monitoring modules can be employed to monitor the drive over the web
- The safety module occupies a separate dedicated connection point ensuring safety integrity
- The drive is operated and commissioned either from a keypad or from a PC tool. The PC tool used with ACS880 is Drive Composer
- 32 drives can be connected onto a panelbus. The panelbus can be used to communicate to many drives, either using the keypad or the composer Pro tool
- 156K of IEC61131 environment is available

### User interfaces

Please refer to page 65 for details of the ACS880 common user interfaces.

# Low voltage AC drives

## ABB industrial drive



ACS880-04- Variants, ratings, types, voltages and prices

### Single drive modules

- 200 kW to 1400 kW, (380 - 690 V)
- Highest power density from a module on the market, extremely compact power module
- Wheeled module supplied with extendable ramp
- Coated boards as standard
- Speed controlled redundant fan cooling arrangement
- TÜV approved safe torque-off (STO) to SIL 3 PL e standard
- Plastic IP20 shrouds supplied which can be substituted for a pair of IP20 cabling panels which allow the module to be removed from the cabinet without disturbing wiring
- Brake chopper optional
- Wide range of cabinet installation options, including instructions for Rittal cabinet installation
- EMC filter for C3 category according to EN 61800-3 (2004)
- Optional common-mode filter
- Optional fieldbus modules, safety module, I/O expansion
- Optional fan kits and cabinet installation kits



For more information – see Technical Catalogue 3AUA0000115038

The following table details the R10 and R11 frames (pictured above).

If you require information on the higher power modules (D8T and R8i), or the extended power range (-XT) please contact ABB.

### 380 to 415 V, 3-phase supply voltage. The power ratings are valid at nominal voltage (400 V)

No-overload (nominal) use		Light-duty use		Heavy-duty use		Max output A	Frame	Fuse A	Heat dissipation	Cooling requirements	Type (+ E210 + E208 + J410 + R700 to order filters, cable boxes and keypad door mounting)	Price IP20
P <sub>N</sub> kW	I <sub>N</sub> A	P <sub>Ld</sub> kW	I <sub>Ld</sub> A	P <sub>hd</sub> kW	I <sub>hd</sub> A							
250	505	250	485	200	361	560	R10	800	5602	1200	ACS880-04-505A-3	£16,893
315	585	315	575	250	429	680	R10	1000	6409	1200	ACS880-04-585A-3	£19,955
355	650	355	634	250	477	730	R10	1000	8122	1200	ACS880-04-650A-3	£22,308
400	725	400	715	315	566	850	R11	1250	8764	1200	ACS880-04-725A-3	£24,500
450	820	450	810	355	625	1020	R11	1600	9862	1200	ACS880-04-820A-3	£26,245
500	880	500	865	400	725	1100	R11	1600	10578	1420	ACS880-04-880A-3	£27,988

\* For fuse selection refer to the hardware manual, weak networks may require a different rating

Price shown is complete with keypad door mounting kit, cabling panels, EMC filter, CMF filter and manuals

Note: Currents match IE3 motor ratings



IP20 shrouds as standard

The ACS880-04 can be supplied in two major variant variants. The standard variant comes complete with IP20 shrouds (plastic) a telescopic ramp, separate control unit and keypad. The customer power cabling is taken directly to the module and would need to be disconnected to allow module removal.

The second variant comes complete with cable panels (option + H381) which fit inside the cabinet. The customer power cabling is attached to these panels, which allows the module to be removed without disconnecting the customer cabling.

In both cases the module is withdrawn down the ramp which is provided.

There is a wide range of other control card and keypad mounting options to allow the unit to integrate into a cabinet. The manual gives extensive instructions for Rittal cabinet installation, including a list of Rittal parts required.



+ H381 cabling panel option

# Low voltage AC drives

## ABB industrial drive

ACS880-04 – Dimensions and options



### Dimensions and weights for drives modules

#### Basic module dimensions (no shrouds or panels)

Frame size	Height (H1) mm	Height (H2) (no pedestal) mm	Width (W1) mm	Depth mm	Weight kg
R10	1462 (1541)	1337	350	506	161
R11	1662 (1741)	1537	350	506	199

Numbers in brackets to top of shroud

#### Module dimensions including the cable panels +H381

Frame size	Height (H3) mm	Height (H4) (no pedestal) mm	Width (W2) mm	Depth mm	Weight kg
R10	1591	1466	329	506	161
R11	1741	1616	329	506	199

### Options

ACS880-04 is a cabinet mounted drive, so the options are designed to complement cabinet installation:

- Cabling is arranged to come in at the top and motor out at the bottom
- Standard offering comes with plastic IP20 shrouds for input and output, and motor terminals are supplied “full sized” allowing for parallel motor cables. The standard configuration is supplied with a separate control unit and keypad
- Option +H370 requests “full sized” terminals on the input power connections, allowing for parallel mains cables
- Option +H381 request full cable panels, which bolt onto the side of the module and onto the side of the cabinet wall (replaces the standard IP20 shrouds and fixed full size cable terminals)
- Option +H356 request DC terminals
- Option +P905 request the control unit to be fitted to the power module
- Option +J414 integrates the control panel onto the front of the power module
- Option +J410 includes a keypad door mounting kit with the module
- EMC filters and common mode filters can be included
- Shrouds, keypads and wheeled pedestal can be removed if required
- Fan kits and cabinet assembly kits are also available
- ATEX compliant options
- Extended power range by paralleling modules (-XT)

All ACS880 drives use the same common options and user interfaces. These are detailed on page 65.

- The drive has three slots for I/O and fieldbus expansion and one drive-to-drive serial communication link
- I/O modules can be chosen from analogue expansion, digital expansion, encoder and resolver feedback options

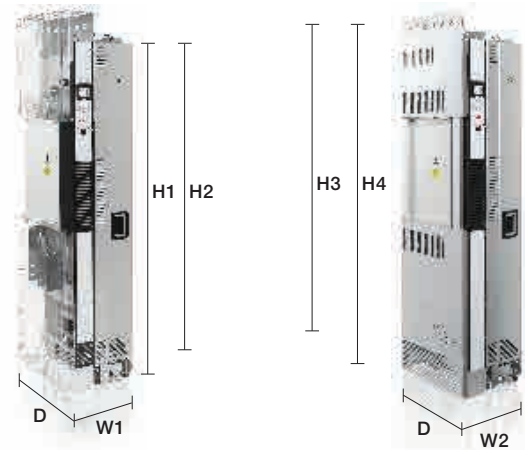

Module showing plastic shrouds fixed

Module showing cabling panels

- Fieldbus modules can be connected to any slot and all of the major industrial fieldbus modules are available. The drive also supports two fieldbus modules at a time, so can control via a traditional industrial fieldbus, but data gather via an Ethernet based protocol
- Remote monitoring modules can also be employed to monitor the drive over the internet
- The safety module occupies a separate dedicated connection point ensuring safety integrity
- The drive is operated and commissioned either from a keypad or from a PC tool. The PC tool used with ACS880 is Drive Composer
- 32 drives can be connected onto a panelbus. The panelbus can be used to communicate to many drives using the keypad or the Composer Pro PC tool

### User interfaces

The ACS880-04 can be supplied with a keypad door mounting arrangement, which requires a single rectangular hole for the cabinet door.



Please refer to page 65 for details of the other ACS880 common user interfaces.

# Low voltage AC drives

## ABB industrial drive



ACS880-07 – Variants, ratings, types, voltages and prices

### Cabinet-built single drive

- 45 kW to 2,800 kW, (380 - 690 V)
- IP21 as standard, IP42 and IP54 as options
- 250 kW based on a single module including rectifier and inverter
- Coated boards as standard
- TÜV approved safe torque-off (STO) to SIL 3 PL e standard
- TÜV approved emergency stopping options
- Extremely compact, internal swinging gate for control options minimises cabinet size, but ensures easy access
- Internal customer wiring is redesigned to give easier access, with pluggable connectors included
- Drive module can be extracted using a set of maintenance rails
- Factory-built cabinet with EMC and thermally type-tested for trouble-free operation
- Extensive range of standard options, that are increased to incorporate the most popular engineered options ordered with the ACS800 range
- Optional UK cable for SWA cables
- Optional motor thermistor and PTC connections
- Internal fieldbus options
- Optional safety module
- Optional I/O modules
- ATEX compliant options



For further information, see Technical Catalogue 3AUA0000098111

### 380 to 415 V, 3-phase supply voltage. The power ratings are valid at nominal voltage (400 V)

No-overload (nominal) use		Light-duty use		Heavy-duty use		Max output A	Frame	Fuse A	Heat dissipation	Cooling requirements	Type (+ E200, + R700 + H358 to order EMC & SWA gland plate)	Price
P <sub>N</sub> kW	I <sub>N</sub> A	P <sub>Ld</sub> kW	I <sub>Ld</sub> A	P <sub>hd</sub> kW	I <sub>hd</sub> A							
55	105	55	100	45	87	148	R6	160	1795	435	ACS880-07-0105A-3	ABB panels can be ordered with a wide range of standard options. Price on application!
75	145	75	138	55	105	178	R6	250	1940	435	ACS880-07-0145A-3	
90	169	90	161	75	145	247	R7	250	2440	450	ACS880-07-0169A-3	
110	206	110	196	90	169	287	R7	315	2810	450	ACS880-07-0206A-3	
132	246	132	234	110	206	350	R8	400	3800	550	ACS880-07-0246A-3	
160	293	160	278	132	246*	418	R8	500	4400	550	ACS880-07-0293A-3	
200	363	200	345	160	293	498	R9	630	5300	1150	ACS880-07-0363A-3	
250	430	250	428	200	363**	545	R9	700	6500	1150	ACS880-07-0430A-3	

\*130% overload, \*\*125% overload

† For fuse selection, refer to the hardware manual

ABB recommends the use of aR fuses for their cabinet drives, other fuses could be used if their melting curve matches ABB's recommendations

# Low voltage AC drives

## ABB industrial drive

ACS880-07 – Dimensions and options

### Dimensions and weights, for cabinet-built drives

Frame size	Height H1 IP22/42 mm	Height H2 IP54 mm	Width mm	Depth mm	Weight kg
R6	2145	2315	430	673	240
R7	2145	2315	430	673	250
R8	2145	2315	430	673	265
R9	2145	2315	830	698	375

Larger powers use R8i modules, please contact ABB for information.

Note: these are the dimensions of the basic cabinet, dimensions will change with the addition of some options

### Options

ACS880-07 is a cabinet-built drive, so its options fit inside the cabinet. The cabinet drive can be fitted with:

- IP21, IP42, IP54, variants
- Emergency stop variants, TÜV approved
- Motor thermistor relays
- Marine construction
- UL approved components
- Various types of cable markings, cabinet heaters, door furniture and lighting etc.
- Top or bottom cable entry for either motor or power cables
- UK gland plates for SWA cables
- 24 V control inside the cabinet
- Different levels of EMC compliance
- Extended warranty
- Additionally, ABB can accommodate any specialised option or feature by using its in-house application design team
- ATEX compliant options

ACS880-07 comes with options that are fitted to the drive module which is inside the cabinet:

- The drive module has three slots for I/O and fieldbus expansion and one drive-to-drive serial communication link.
- I/O modules can be chosen from analogue expansion, digital expansion, encoder and resolver feedback options
- Fieldbus modules can be connected to any slot and all of the major industrial fieldbus modules are available. The drive also supports two fieldbus modules at a time, so can control, via a traditional industrial fieldbus, but data gathers via an Ethernet-based protocol
- Remote monitoring modules can be employed to monitor the drive over the internet



- The safety module occupies a separate dedicated connection point ensuring safety integrity
- The drive is operated and commissioned either from a keypad or from a PC tool. The PC tool used with ACS880 is Drive Composer
- 32 drives can be connected onto a panelbus. The panelbus can be used to communicate to many drives, either using the keypad or the Composer Pro tool

### User interfaces

Please refer to page 65 for details of the ACS880 common user interfaces

# Low voltage AC drives

## ABB industrial drive

ACS880 – Multidrive



A multidrive is a custom-made system to suit a larger application or a process line. The system contains multiple inverter stages of differing size, supplied from a common DC bus.

ABB can provide a ready-made cabinet, or it can provide system integrators with a comprehensive range of power modules and mechanical kits to build bespoke cabinets for end clients.

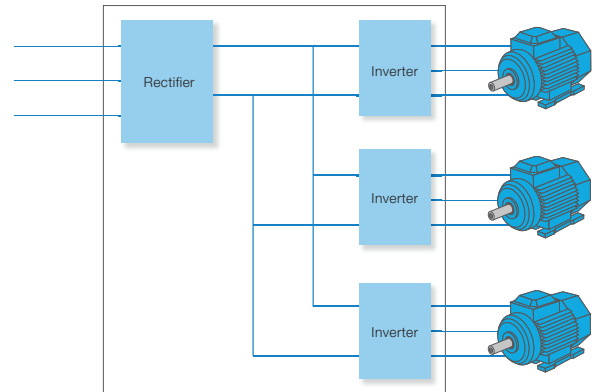

4

### Multidrive cabinets

- 1.5 kW to 5600 kW
- IP21 as standard IP42 as option
- High packing density with 16 inverter units (up to frame size R2i) can be installed into one 1000 mm cabinet
- Diode bridge that is highly reliable with high power density
- Fast connectors for motor cables in the bottom part of the cabinet, making installation easy
- Integrated safety including safe torque-off (STO) as standard with several safety functions as options
- Coated boards as standard
- Braking options
- DC fuse disconnectors, DC fuses or DC fuse switch including charging circuit for inverters
- Cabinet light and heater options
- Highly efficient thermal handling as heat loss of each inverter unit is guided to the back of the cabinet. All cabinets are their own separate compartment
- Long lifetime capacitors and high efficiency cooling fan with speed or on-off control
- TÜV approved emergency stops
- ACS880 user interfaces described later



For further information, see Technical Catalogue 3AUA0000115037

### Multidrive modules

- 1.5 kW to 3200 kW
- A range of IP20 modules and IP00 kits to generate bespoke multidrive systems built-into system integrators own panels
- Modules have no rectifiers, they are inverters only and range in frames from R2i to R8i (i=inverter only)
- Contain internal pre-charge circuits making them easier to integrate
- Selection of rectifiers available to generate DC link for the system. Active IGBT rectifiers and diode modules are available
- New style diode module (DxD) only contains diodes, making it more competitively priced and more reliable
- New RRU modules, regenerative rectifiers, cost efficient regeneration
- Cabinet kits ensure easy integration
- New redundancy configurations for the modules and the fan control for better problem ridethrough



For further information, see Technical Catalogue 3AUA0000115038

- Safe torque-off (STO) as standard with several safety functions as options using the new safety module
- Coated boards as standard



# Low voltage AC drives ABB industrial drive

ACS880 – Common user interfaces



## Control panel/keypad

State-of-the-art high resolution keypad brings a new level of usability to the drives marketplace. The keypad ensures maximum usability and intuitive use. The keypad display is extremely high definition and is visible in any control room. Innovative views, transitions and screen will be very familiar to users of smart phones. The display supports graphics and icons to help the user navigate. The keypad also supports text editing to allow users to re-name fault messages to match plant specific actions. Customer specific start-up images and parameter favourites make the keypad easily tailorable to customers and OEMs alike.



- Bluetooth variant as standard
- High resolution, high contrast display
- Multiple display screens supporting graphs, bar graphs and graphical meters

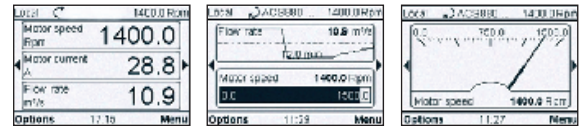

Icon driven menu selections and displays

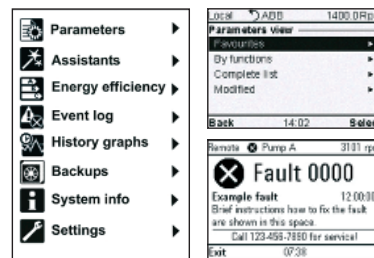

- Real-time clock
- USB connection – no special leads required

## Bluetooth keypad and DriveTune app

Using a special Bluetooth enabled keypad, ABB can offer connection to the mobile phone using an app called DriveTune. There are versions of the app for IOS and Android operating systems.



## Removable memory unit

The memory unit stores the complete parameter and firmware set for the drive. Should a drive need to be replaced, swapping the memory unit to the new drive will transfer a complete drive set-up – absolutely no recommissioning is required. This reduces down time.



## Fieldbus

The ACS880 supports an extensive list of fieldbus modules for connectivity to industrial networks. These modules are common with other drives within the ABB drives range. Two modules can be operated together.



## Expansion for analogue and digital I/O and speed feedback

Additional I/O can be added to the ACS880. This I/O can be addressed by the fieldbus so that the ACS880 can be used as an I/O “nest”, giving connectability from the process to the drive, for example, flow or level transducers. All modern speed feedback devices are supported.



## Safety modules built in, FSO-12, FSO-21 and FSE-31

SIL3 rated TÜV approved safety modules. FSO-12 and FSO-21 offer a wide range of functions from the IEC 61800-5-2 standard. FSE-31 offers a safe encoder interface, and the whole family can communicate over a ProfiSafe network.



## ATEX approves PTC interface FPTC-02

ACS880 has an ATEX certified STO, meaning no “upstream” contactor is required. With the FPTC-02 the motor PTC can be connected directly to the drive (no external relays). The FPTC-02 has a direct connection to the STO (and can connect to the FSO if needed) making a totally integrated ATEX solution.



## Drive Composer PC tool

New PC tool for the ACS880 family come in two variants – the “entry” level is a free of charge point-to-point tool and allows simple parameter editing and storage, as well as monitoring and commissioning support, while the “Pro” level has all of this as well as animated control diagrams and extended commissioning, monitoring and diagnostic support, as well as the ability to program the safety functions. The Pro tool also allows the user to connect to multiple drives either over “panelbus” where the keypad port is used, or over Ethernet.



# Low voltage AC drives

## ABB industrial drive

ACS880 – Variants, ratings, types, voltages and prices

### Typical I/O and control connections

The ABB industrial drive family uses the same keypad and software structure throughout its entire range. There are three control cards that have different physical shapes, but the same interfaces. All I/Os are fully configurable to be whatever function is required. The diagram shows a typical I/O connection.

The ACS880 uses macros to configure its I/O. The macros pre-define the I/O functionality to comply with popular industrial configurations. It is also possible to configure the I/O manually to any function required.



The ACS880-01 control card showing the colour coded terminal strips

XPOW		External power input	
1	+24VI	24 V DC, 2 A	
2	GND		
XAI		Reference voltage and analogue inputs	
1	+VREF	10 V DC, $R_L$ 1 to 10 kohm	
2	-VREF	-10 V DC, $R_L$ 1 to 10 kohm	
3	AGND	Ground	
4	AI1+	<b>Speed reference</b>	
5	AI1-	0(2) to 10 V, $R_{in}$ > 200 kohm	
6	AI2+	By default not in use.	
7	AI2-	0(4) to 20 mA, $R_{in}$ > 100 ohm	
J1	J1	AI1 current/voltage selection jumper	
J2	J2	AI2 current/voltage selection jumper	
XAO		Analogue outputs	
1	AO1	<b>Motor speed rpm</b> 0 to 20 mA, $R_L$ < 500 ohm	
2	AGND		
3	AO2	<b>Motor current</b> 0 to 20 mA, $R_L$ < 500 ohm	
4	AGND		
XD2D		Drive-to-drive link	
1	B	Drive-to-drive link or built-in Modbus	
2	A		
3	BGND		
J3	J3	Drive-to-drive link termination switch	
XRO1, XRO2, XRO3 Relay outputs			
1	NC	<b>Ready</b> 250 V AC/30 V DC 2 A	
2	COM		
3	NO		
1	NC	<b>Running</b> 250 V AC/30 V DC 2 A	
2	COM		
3	NO		
1	NC	<b>Faulted (-1)</b> 250 V AC/30 V DC 2 A	
2	COM		
3	NO		
XD24 Digital interlock			
1	D1IL	By default not in use	
2	+24VD	+24 V DC 200 mA	
3	DICOM	Digital input ground	
4	+24VD	+24 V DC 200 mA	
5	DIOGND	Digital input/output ground	
J6		Ground selection switch	
XDIO Digital input/outputs			
1	DIO1	Output: Ready	
2	DIO2	Output: Running	
XDI Digital inputs			
1	DI1	Stop (0)/Start (1)	
2	DI2	Forward (0)/Reverse (1)	
3	DI3	Reset	
4	DI4	Acceleration and deceleration select	
5	DI5	Constant speed 1 (1=On)	
6	DI6	By default not in use	
XSTO Safe torque-off			
1	OUT1	Safe torque-off. Both circuits must be closed for the drive to start.	
2	SGND		
3	IN1		
4	IN2		
X12	Safety functions module connection		
X13	Control panel connection		
X205	Memory unit connection		

# Low voltage AC drives

## ABB industrial drive - variants



ACS800 – Variants, ratings, types, voltages and prices

### Low harmonic, active rectifier drives

These are a dedicated range of low harmonic drives based on active rectifier technology. No regenerative capability ensures no mistakes on generator supplies, while still retaining a low 2-4 percent total harmonic distortion (THD) signature.

### ACS800-31, wall-mounted

- 5.5 kW to 110 kW (230 - 690 V)
- IP21 as standard
- Single package for easy cabinet installation, reducing installation time and cabinet space

### ACS800-37 and ACS880-37 cabinet-built

- ACS800 power range from 37 kW to 2700 kW (230 to 690 V)
- ACS880 power range from 250 kW to 3200 kW
- IP21 as standard; IP22, IP42, IP54 and IP54 R available as options
- Wheel-out power modules for improved manual handling
- Plug-in power connectors for easy maintenance and redundancy
- Power module redundancy for improved availability
- Factory-built cabinets ensure good installation



For further information, see Technical Catalogue 3AFE68375126

The R5 and R6 modules are detailed below. Please contact ABB if you require higher powers. Also, fully regenerative products are available - ACS800-11 and ACS800-17. Please refer to page 69 for more information.

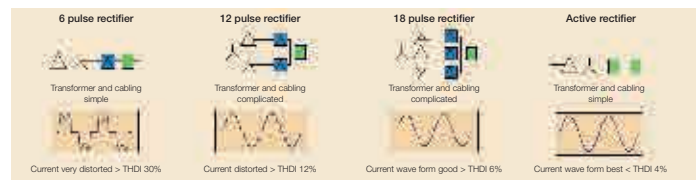

Alternatives in reducing line harmonics

### Low harmonic, wall-mounted drives - ACS800-31

380, 400 or 415 V, 3-phase supply voltage. The power ratings are valid at nominal voltage (400 V)

No-overload use		Light overload		Heavy-duty use		Max output	Frame	Fuse A	Heat dissipation	Cooling requirements	Type (+E200 to order the EMC filter)	IP21 price with keypad
P <sub>cont. max</sub>	I <sub>cont. max</sub>	P <sub>N</sub>	I <sub>N</sub>	P <sub>hd</sub>	I <sub>hd</sub>							
kW	A	kW	A	kW	A	A		†Type gG	W	m³/h		
15	34	15	32	11	26	52	R5	40	550	350	ACS800-31-0016-3	£4,873
18.5	38	18.5	36	15	34	61	R5	40	655	350	ACS800-31-0020-3	£5,501
22	47	22	45	18.5	38	68	R5	50	760	350	ACS800-31-0025-3	£6,264
30	59	30	56	22	45	90	R5	63	1000	350	ACS800-31-0030-3	£7,171
37	72	37	69	30	59	118	R5	80	1210	350	ACS800-31-0040-3	£8,476
45	86	45	83	30	65	137	R5	100	1450	350	ACS800-31-0050-3	£10,094
55	120	55	114	45	88	168	R6	125	1750	405	ACS800-31-0060-3	£11,575
75	150	75	143	55	117	234	R6	160	2350	405	ACS800-31-0070-3	£13,518
90	165	75	157	75	132	264	R6	200	2800	405	ACS800-31-0100-3	£15,661

Other ratings and voltage ranges available, 230 V, 500 V, 690 V. Price on application.

Price includes 2nd environment EMC filter and control panel

Prices for low harmonic cabinet drives ACS800-37 available on application

† For fuse selection, refer to the hardware manual. Weak networks may require aR fuses

# Low voltage AC drives

## ABB industrial drive - other variants



ACS800 & ACS880 – Dimensions and options

### Dimensions and weights, ACS800-31

Frame	H	W	D	Weight
size	mm	mm	mm	Kg
R5	816	265	390	62
R6	970	300	440	100

Height includes cable box, one enclosure, no external items

4

### Options for ACS800-31, wall-mounted

- UK gland box to accommodate SWA cable
- Different levels of EMC compliance
- SIL2 safe torque-off interface (unit mounts outside the drive)
- Coated boards standard
- Extended warranty
- Marine certification mounts and kits

### Options for ACS800-37, cabinet-built

Being a cabinet drive, all of the options available for ACS800-31 are valid as they fit inside the cabinet.

Additionally, the cabinet drive can be fitted with:

- IP21, IP22, IP42, IP54, IP54R variants (no IP55)
- Emergency stop variants
- Motor thermistor relays
- ATEX-approved motor protection
- Marine construction
- UL-approved components
- Various types of cable markings, cabinet heaters, door furniture and lighting etc.
- Sine filter fitted to output (for older motors)
- Top or bottom cable entry for either motor or power cables
- UK gland plates for SWA cables
- 110 V control inside the cabinet
- ABB can accommodate any specialised option or feature, by using its in-house application design team
- SIL2/PL d safe torque-off interface
- Coated boards

### ACS880-37 cabinet-built options and user interfaces

The ACS880-37 is part of the all compatible ACS880 range. It follows the same build format and options as the ACS880-07 (see page 63) and has the same ACS880 user interfaces (see page 65)



Ratings and dimensions for larger variants available on request

### User interfaces

All ACS800s use the same common options and user interfaces, these are detailed on page 71.

- The drive has two slots for I/O and fieldbus expansion and one slot for an optical interface (an additional mother board can also be added – giving three more slots)
- I/O modules can be chosen from analogue expansion, digital expansion, encoder and resolver feedback options
- Fieldbus modules are always fixed to slot one, and all of the major industrial fieldbus modules are available
- The drive can be ordered with specially designed application specific software variants. There are 11 variants available including crane, master follower, winder control, etc. The advantage of selecting these pre-written software variants is that they cover the market requirements. They are tested and certified by ABB and come complete with a User Manual and cabling instructions.

# Low voltage AC drives

## ABB industrial drive - other variants



ACS800 – Variants, ratings, types, voltages and prices

### Regenerative, active rectifier drives

#### ACS 800-11, wall-mounted

- 5.5 kW to 110 kW (230 - 690 V)
- IP21 as standard
- Active rectifier unit
- Single package for easy cabinet installation, reducing installation time and cabinet space

#### ACS800-17 and ACS880-17, cabinet-built

- ACS800, 45 kW to 2500 kW (230 - 690 V)
- ACS880-17, 250 kW to 3200 kW
- IP21 as standard, IP22, IP42, IP54 and IP54 R available as options
- Wheel-out power modules for improved manual handling
- Plug-in power connectors for easy maintenance and redundancy
- Power module redundancy for improved availability
- Factory-built cabinets ensure good installation and compliance with standards
- ATEX approved PTC interfaces and blanket certification with ABB motors



For further information see Technical Catalogue 3AFE 68375126

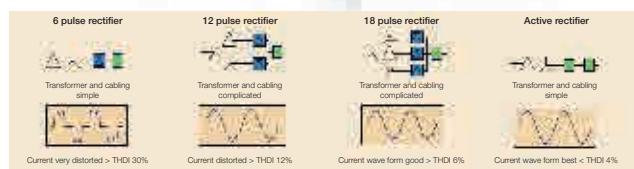

Alternatives in reducing line harmonics

### Regenerative, active rectifier drive modules - low harmonic ACS800-14

- 75 kW to 1700 kW (380 - 690 V)
- IP00 kits
- Assembly kits for Rittal cabinets and generic cabinets
- Separate controllers for galvanic isolation
- Requires a separate +24 V DC supply at 3 A
- Active supply unit can be configured for low harmonic mode (2-4 percent harmonic distortion) or regenerative mode, for better dynamic performance
- Comprehensive installation instructions and CAD drawings



For further information see Technical Catalogue 3AFE 68404592

### Liquid cooled modules

#### ACS800-x04LC

- Extremely compact size, compared to air-cooled
- 98 percent of drive losses transferred to liquid - removes the need for air-conditioned control rooms
- Tested electrical/mechanical kits available - which make different solutions easy to build
- ACAD, PDF and full 3D EPLAN® modelling support
- Pre-designed mounting frames available to reduce design time
- Liquid / liquid-heat exchanger assemblies can be supplied by ABB
- Module features:
  - Diode supply modules include line side chokes
  - Inverter modules include du/dt filters
  - Easy structure, fewer components
  - Inverter units, IGBT supply units and dynamic braking units are based on one common R8i module



For further information see Technical Catalogue 3AFE68404592

# Low voltage AC drives

## ABB industrial drive - other variants

ACS800 – Variants, ratings, types, voltages and prices

### Liquid-cooled drives

#### ACS800 - 17LC and ACS800 - 37LC

- 37 kW to 2700 kW, (380-690 V)
- IP42 as standard, IP54 as option
- ACS800-17LC, fully regenerative, ACS800-37LC, low harmonic
- Provides reliable operation in adverse conditions
- Silent and safe operation without the need for air ventilation or air conditioning, fully enclosed cabinets, smaller than previous generation
- Extensive range of cabinet options, including water pumping and heat exchanger cabinets
- Marine enclosure available
- Parallel modules allow redundant configuration
- Ideal where space is limited, in harsh environments, or at sites that require quieter operation, in applications where cooling water is freely available
- IEC, UL, CSA, Lloyds, DNV, ABS approvals
- ATEX-approved PTC interfaces and blanket certification with ABB motors



For further information see Technical Catalogue 3AFE68375126

# Low voltage AC drives

## Other variants

ACS800 – Common user interfaces

### Control panel

The control panel features a full-text multilingual display. Dedicated keys allow fast access to actual signals, parameters, assistant functions and drive information. The panel can be used for parameter copying and for configuring adaptive programmes, working as a PLC inside the drive. Local motor control and parameter copying is also possible.



### Panel mounting kits

Kits are available that allow mounting on the cabinet door, or in a holder inside the cabinet. The panel can be screwed to the cabinet door, without the need for an additional holder.



### Fieldbus

The ACS800 supports an extensive list of fieldbus modules for connectivity to industrial networks.



### I/O expansion

ACS800 can be fitted with a large range of analogue and digital I/O modules to expand its I/O capability.



### DriveWindow - PC Tool

DriveWindow is a high specification, high speed commissioning, maintenance and monitoring tool for the ACS800 drive range. It operates over an optical fibre link. (Drive requires an RCDO module)

### DriveAP - PC Tool

DriveAP allows access to the ACS800 adaptive, block programming environment.

### Typical I/O and control connections

The ABB industrial drive family uses the same control card, keypad and software structure throughout its entire range. Analogue and digital I/O channels are used for different functions such as control, monitoring and measurement purposes (e.g. motor temperature). In addition, optional I/O extension modules are available providing additional analogue or digital I/O connections.

Below are the standard drive control I/O of the ABB industrial drive with factory macro. For other ACS800 application macros the functions may be different. Please refer to the firmware manual for details.

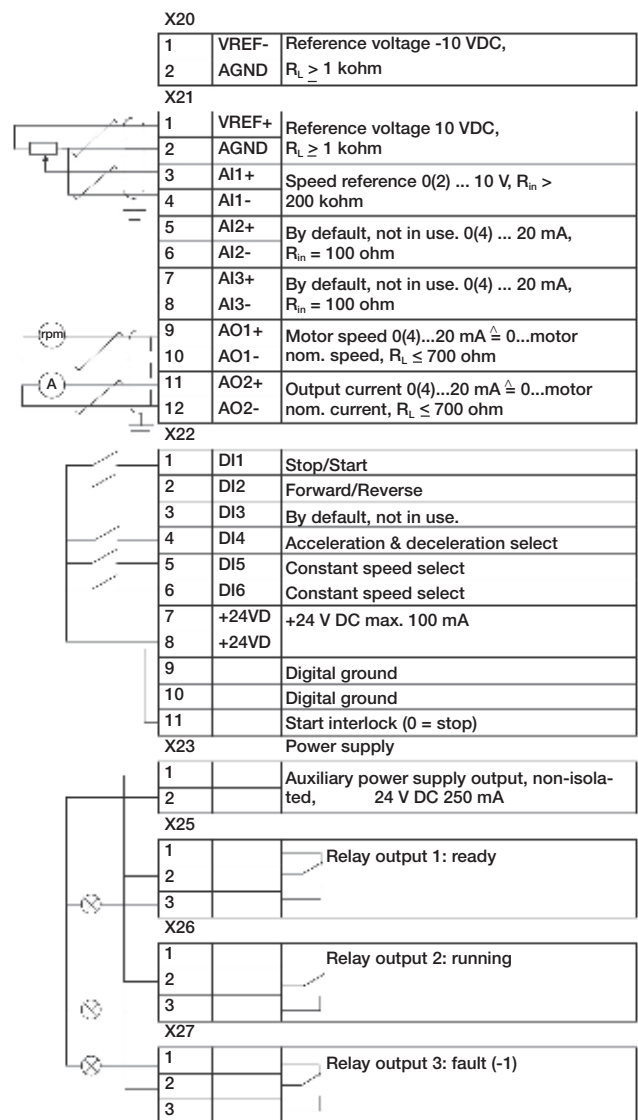

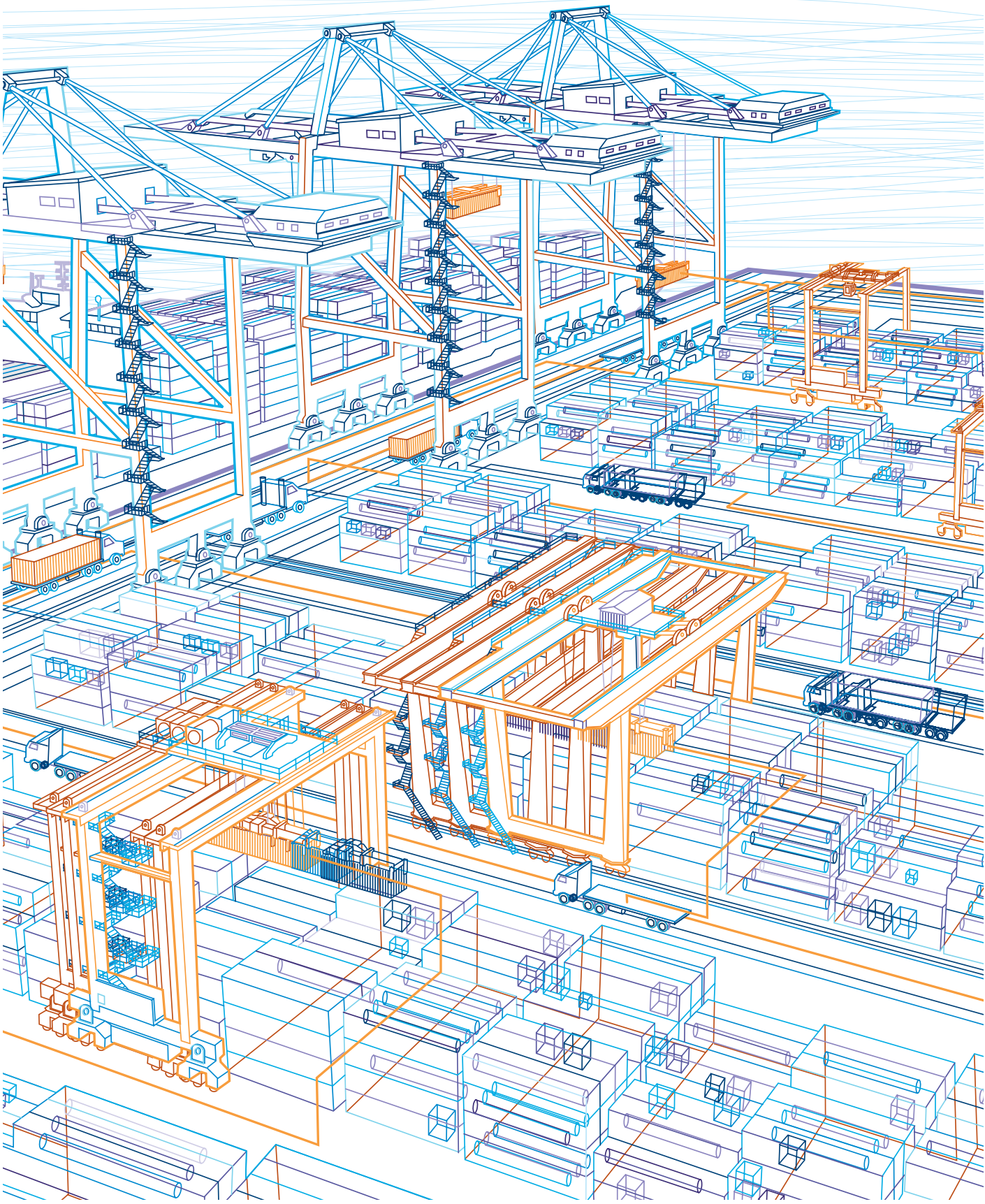



## Other drives, accessories and services

<a href="#">Servo drives</a>	74
<a href="#">Motion controllers</a>	75
<a href="#">ABB machinery drives</a>	76
<a href="#">Medium voltage AC drives</a>	77
<a href="#">DC drives</a>	78
<a href="#">Power quality filters (PQFs)</a>	79
<a href="#">Remote monitoring and support options</a>	80
<a href="#">Software tools</a>	81
<a href="#">Reliability Assessment, service and training</a>	83

# Other drives, accessories and services

## Servo drives

### Analogue, PTO, PowerLink and EtherCAT® options

#### MicroFlex Analogue

- Compact motion control drive for single- and three-phase operation
- $\pm 10$  V analogue speed / torque demand or pulse + direction inputs
- Choice of resolver feedback or incremental encoder / SSI
- Pulse train control inputs compatible to pulse train output (PTO) module FM562 for AC500 and AC500-eCo
- 1 or 3-phase operation 105...250 V AC

#### MicroFlex e100

- Compact motion control drive for single and three-phase operation
- Ethernet PowerLink technology for real-time motion control
- MINT programming for multitasking control of communications, logic, motion and HMI interaction in simple motion applications
- 1 or 3-phase operation 105...250 V AC
- 3, 6 and 9 A rms

#### MicroFlex e150

- Compact motion control drive with embedded safety for single and three-phase operation
- Embedded Ethernet including EtherCAT real-time, EtherNet/IP, and ModbusTCP
- Advanced MINT programming for multitasking control of communications, logic, motion and HMI interaction in high performance motion applications
- 1 or 3-phase operation 105...250 V AC
- 3, 6 and 9 A rms
- IP20 enclosure for cabinet installation (UL open)

#### MotiFlex e180

- EtherCAT®, Modbus/TCP, EtherNet/IP and PowerLink
- DSL combined motor power and feedback in one cable
- Advanced MINT programming for multitasking control of communications, logic, motion and HMI interaction in high performance motion applications
- Three-phase operation 200...480 V AC
- 3.0..55 A rms in four frame sizes
- IP20 enclosure for cabinet installation (UL open)
- Suitable for single drive and multi axis systems

- 3, 6 and 9 A rms
- IP20 enclosure for cabinet installation (UL open)
- Auto-tuning and anti-resonance digital filters
- Suitable for single drive and multi axis systems
- Controls rotary and linear AC servo motors

#### Options

- Space saving footprint EMC filter
- Brake units

For further information, see flyer “ABB motion control drives, MicroFlex brushless AC servo drives”, code: 3AUA0000123110 EN.

- IP20 enclosure for cabinet installation (UL open)
- Suitable for single drive and multi axis systems
- Controls rotary and linear AC servo motors

#### Options

- Space saving footprint EMC filter
- Brake units

For further information, see flyer “ABB motion control products, MicroFlex e100 servo drives”, code: 3AUA0000116018 EN.

- Suitable for single drive and multi axis systems
- Controls rotary and linear AC servo motors
- Safe Torque-Off (STO) feature as standard

#### Options

- MINT Motion programming
- Space-saving footprint EMC filter
- Resolver adapter
- Dual encoder splitter
- Brake units

For further information, see flyer “ABB motion control products, MicroFlex e150 servo drives”, code: 3AUA0000097609 EN.

- Controls rotary and linear AC servo motors
- Safe Torque-Off as standard
- Memory unit for firmware, settings and functionality level

#### Options

- Drive functionality levels (single axis MINT motion)
- Feedback options, resolver, encoder, serial encoders or DSL One cable technology
- Filters, brake resistors and chokes

For further information, see flyer “ABB motion control products, MotiFlex e180 servo drives”, code: 3AUA0000168682.



# Other drives, accessories and services

## Motion controllers

### MINT programmable, analogue, PTO, CANopen and PowerLink

#### NextMove ESB-2

- Compact panel mount motion controller
- Up to 8 axis of coordinated motion
- Stepper and analogue axis control
- CANopen manager for system expansion
- MINT programming for multitasking control of communications, logic, motion and HMI interaction in simple motion applications
- 4 x PTO (stepper) axis
- 3 or 4 x analogue controlled axis with encoder feedback
- Digital and analogue I/O including 4 x high speed registration latches
- Economical and simple to install

- USB, serial and CANopen® provide flexible communications to PLC, distributed I/O and other devices
- Firmware variant allows the controller to operate as a CANopen® DS402 master and control up to 64 axis

#### Options

- RS232 or RS485 serial option
- Differential/single-ended stepper interfaces
- 7 axis or 8 axis variants



Compact motion controller for analogue and stepper control

Number of axis	Serial port	Order code	
		Differential stepper	Single ended stepper
7	RS232 / USB	NSB202-501W	NSB203-501W
7	RS485 / USB	NSB202-502W	
8	RS232 / USB	NSB204-501W	NSB205-501W
8	RS485 / USB	NSB204-502W	

#### NextMove e100 (Ethernet PowerLink, Modbus® TCP and Modbus RTU)

- Compact, high performance motion controller
- Real-time Ethernet PowerLink and Modbus® TCP/IP
- 8 or 16 axis of interpolated motion
- (16 MN + 14 CN) profiled axis = max. 30 Powerlink axis
- 4 stepper axis/3 analogue axis
- CANopen® network manager
- RS232/422 and USB communications
- Advanced multitasking MINT programming
- ActiveX® controls
- Integrated digital/analogue I/O including high speed registration inputs



Compact motion controller with real-time Ethernet PowerLink technology

Number of axis	Order code	
	Differential stepper	Single ended stepper
8	NXE100-1608DBW	NXE100-1608SBW (1)
16	NXE100-1616DBW	

(1) For use with DSMS stepper/driver.

# Other drives, accessories and services

## ABB machinery drives

### ABB machinery drives

ABB machinery drives are designed to suit the needs of OEMs with reasonably complex machinery requirements. The range integrates with the ABB servo drive range, allowing capable and suitably priced drive packages for machinery applications. The range has scalable safety, by way of STO to SIL 3 (PL e) as standard with FSO available on the ACS880. ABB machinery drives feature sequence programming, adaptive programming or IEC 61131 (CODESYS) programming. The drives can be customised for OEMs down to parameter visibility levels to protect the set-up.

### ACS380

- 0.25 kW to 3.0 kW (240 V), 0.37 kW to 11 kW (400 V), wider range by end 2017
- Part of the “all compatible” family
- Same PC tool, keypad and fieldbuses as the other ranges
- Basic and demanding constant torque applications, including brake control
- IP20 optimised for cabinet mounting, built-in keypad
- Highly compact drives with enhanced cooling design
- Built-in Modbus, EMC C2, STO to SIL 3, robust motor control
- Control induction, permanent magnet and SynRM motors
- Two variants, one containing traditional I/O, the other pre-configured for a fieldbus
- Contains sequence programming and adaptive programming. Each sequence is freely programmable

### ACS880-M04

- 0.37 kW to 18.5 kW (240 V), 0.75 kW to 45 kW (400 V)
- Part of the “all compatible” family, and based on the ACS880 control program
- Same PC tool, keypad and fieldbuses as the other ranges
- More demanding constant torque applications, industrial positioning
- IP20 optimised for cabinet mounting
- Built-in Modbus, EMC C2, DTC motor control
- Control induction, PM and SynRM motors
- STO to SIL 3 as standard. Extended machinery safety with FSO module
- Memory module contains all of the settings, zero re-commissioning
- Extensive range of feedback interfaces
- Contains adaptive programming and fulfils IEC 61131 (CODESYS) programming



# Other drives, accessories and services

## Medium voltage AC drives



ABB offers a complete range of medium voltage AC drives for speed and torque control and for the starting of large AC motors. The drives feature an arc-resistant design that protects workforce and goods from electric arcs. Certified functional safety features and an integrated DC grounding switch ensure safety and reliability.

### ACS580MV

- General purpose drive from 200 kW to 6.3 MW
- Air-cooled with integrated input transformer
- Output voltage 6 kV to 11 kV
- New generation of cascaded h-bridge topology allows the use of standard motors
- Optimal network friendliness due to 30-54 pulse configuration

### ACS1000i

- Single drives 315 kW to 2 MW
- Output voltage 2.3 kV to 4.16 kV
- Air-cooled, 24-pulse drive with integrated input transformer
- Retrofit-ready for existing motors, suitable for most MV applications
- Integrated output sine filter for pure sinusoidal voltage and current output
- Offshore cabinet versions available

### ACS1000

- Single drives from 315 kW to 5 MW
- Output voltage 2.3 kV to 4.16 kV
- Air-cooled (315 kW to 2 MW) and water-cooled (2 MW to 5 MW) versions
- Retrofit-ready for existing motors, suitable for most MV applications
- Integrated output sine filter for pure sinusoidal voltage and current output
- Offshore cabinet versions available

### ACS2000

- Single drives, air-cooled from 250 kW to 3.2 MW
- Output voltage 4.16 kV to 6.9 kV
- Active rectifier unit or 24-pulse diode front end for minimal line side harmonics
- Regeneration and power factor correction with active rectifier
- Direct-to-line versions for operation without an input transformer
- Optional integrated input transformer
- Multilevel topology allows the use of standard motors
- Simple drive system integration
- Modular power modules for reduced MTTR
- Sine filter output optional, for retrofit and long cable run applications

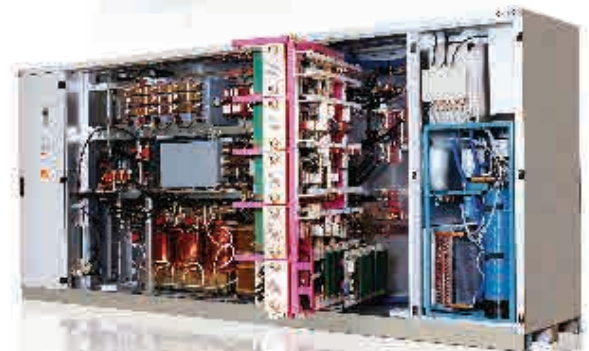

# Other drives, accessories and services

## Medium voltage AC drives and low voltage DC drives



### Medium voltage drives cont...

#### ACS5000

- Single drives from 2 MW to 36 MW
- Air-cooled (2 MW to 7 MW) and water-cooled (5 MW to 36 MW) versions
- Air-cooled version with integrated input transformer (2 MW to 6 MW)
- Output voltage 6 kV to 13.8 kV
- Multilevel topology allows the use of standard motors
- Multilevel fuseless topology results in a drive with unbeatable efficiency, reliability and footprint
- Optimal network friendliness due to 36-pulse configuration



#### ACS6000

- Single or multidrives, water-cooled 5 MW to 36 MW
- Output voltage 2.3 kV to 3.3 kV
- Active rectifier unit available for 4-quadrant operation, reduced harmonics and adjustable power factor
- Line supply unit available for 2-quadrant operation and a constant power factor of 0.96 across entire speed range
- Modular design for optimum configurations, including multidrive and redundant configurations
- Offshore cabinet versions available



#### MEGADRIVE LCI

- 2 MW to 72 MW (higher power on request)
- High power with series connection of thyristors
- N+1 thyristor redundancy possible
- Fuseless design
- Water- and air-cooled converters available
- Line side harmonics: 6-pulse, 12-pulse or 24-pulse
- Motor side harmonics: 6-pulse or 12-pulse
- High converter efficiency
- Proven technology and design
- Complete package solutions including transformers, drives and motors



### ABB general purpose DC drives

#### DCS550

- A digital DC drive targeted at OEMs, such as machine builders
- Range from 20 to 1000 A DC
- 230 V AC - 525 V AC
- Start-up assistants and commissioning wizards
- Extensive range of fieldbus interfaces
- Adaptive program for additional flexibility
- Onboard field controller



# Other drives, accessories and services

## Low voltage DC drives and power quality filters (PQF)

### ABB industrial DC drives and DC heaters DCS800, DCT880

- From 25 to 5200 A
- Commissioning wizard gives easy start-up
- Easy to use - standard macros or user programmability
- Intuitive control panel with 'Help' key, consistent with many of the AC drives
- Adaptive programming for additional flexibility
- Modules can be connected in parallel up to 20,000 A
- Uses ACS800 I/O option modules and fieldbus modules
- I/O is backward compatible with DCS500 and DCS600
- Field converters built-in (up to 25 A)
- The drive can be ordered as an electrical heater control, the DCT880, ideal for all industrial heating



### Power quality filters - overview

- Actively eliminates harmonics in a controlled way
- Filters up to 50th harmonic in accordance with G5/4 requirements. Each harmonic individually programmable
- Redundancy feature allows units to continue when others have shut down
- Active filters - only work when harmonics are present thereby reducing unwanted losses, resulting in greater overall efficiency
- Close loop for better measurement of harmonics - thereby more accurately eliminating the potentially damaging harmonic
- Auto-detection of CT polarity - ensures accurate current distortion readings on network, resulting in easy commissioning
- Stores record trail. Fault and event log - any trip will have a record trail



### PQFM, PQFI

- Available in IP00 back plate or IP21, IP42 cabinets
- New intuitive user interface
- Current ratings, 70 A, 100 A, 130 A, 150 A, 250 A, 450 A, per module. The modules can be connected in parallel to a maximum of eight modules of equal rating

### PQFs

- Small compact unit suitable for wall mounting
- Low ratings available from 30 A, 45 A, 60 A, 70 A, 80 A, 90 A, 100 A, 120 A. The modules can be connected in parallel to a maximum of four modules of equal rating
- Same user interface as the larger units
- Available in IP30



# Other drives, accessories and services

## Remote monitoring and support options

### Remote monitoring overview

Remote monitoring is the reporting of information back to the user, from a remote station or location. Typical remote monitoring information can include:

- Energy consumption and savings
- Motor condition
- Warnings (predictive maintenance), faults and alarms
- Diagnostics
- Monitoring actual values and parameters
- Parameter access is possible, but is not the primary function of remote monitoring



### Monitoring Drives over “1-Wire” networks

#### Drive Composer Pro

Drive Composer Pro is able to communicate to the all compatible drives range over existing ethernet fieldbus networks. This ability to use existing control networks for drive communication is known as “1 wire” tools networks, and clearly reduces installation costs as only 1 communications network is required.

#### Ethernet adapters

The ABB range of drives can be fitted with Ethernet adapters which allow them to communicate on Ethernet networks. The FENA-21 is two-port so removes the need for a switch. Once on a company network the drive can be monitored from anywhere within that company, or if firewall allow, from anywhere on earth. The FENA-21 also contains a web environment.



### Ethernet adapter for ABB industrial drives

#### NETA-21

NETA-21 module provides remote access for ABB drives and connected devices. The module connects to the drive via several different connection possibilities:

- 2 x panel ports (32 drives per port)
- Optical connection (10 drives)
- Ethernet connection (32 drives)
- RS485 Modbus (32 devices)

It can send process data, data logs and event messages independently, without a PLC or a dedicated on-site computer. The module can send either e-mails or SMS text messages to inform the user of the status of the drive(s) connected to it. It has an internal web server for easy configuration and drive access.



### ABB DriveTune wireless App

Drivetune is the smart mobile app enabling wireless communication to ABB low voltage drives. The drive needs to have the Bluetooth enabled keypad fitted. You will be able to start-up your drive and commission with your phone using simple settings and widgets. The appealing dashboard shows intuitively drive status, performance and configuration.



### High speed drive monitoring – remote diagnostics

#### DriveMonitor

DriveMonitor is a service tool which can be fitted to any ABB industrial drive in case of site problems and issues. It uses high speed optical connections to the drives power stages and monitors all of the switching signals sent. In this way complicated system problems can be diagnosed. DriveMonitor can also be used as a system optimisation and recording tool, as its memory buffers can save up to one years worth of performance data.







**Cut the cord.**  
Access the drive without the cord with Bluetooth enabled keypad.



**Lose the Ladder**  
Users won't need to access difficult-to-reach work areas to access information necessary to help them commission and tune a drive.



**Skip the steps**  
The drive will register within 75m (246ft) of the smartphone or tablet.



**Protect your personnel.**  
Users won't need to enter hazardous areas to access information necessary to help them commission and tune a drive.



**Bring Your Own Device**  
No need to learn another device. ABB's DriveTune app will work on your smartphone or tablet.



# Other drives, accessories and services

## Software tools

ABB offers several software tools to facilitate and enhance the use of ABB drives. These tools provide a user-friendly and easy-to-use approach for the selection, commissioning and use of AC drives.

### Integration and programming tools

#### Drive Composer



The Drive Composer PC tool offers fast and harmonised set-up, commissioning and monitoring for the new ABB all compatible drive portfolio. The tool has two variants, a free version called Drive Composer Entry and a professional

level tool which is licensed called Drive Composer Pro. The free version of the tool provides start-up and maintenance programming with monitoring and parameter editing, while the professional version provides additional features such as custom parameter windows, control diagrams for easy parameter editing of the drive's configuration and the ability to programme the built-in safety module. Drive Composer has add-ons for adaptive programming and enables CODESYS programming for more complicated system designs. CODESYS requires Automation Builder.



Drive Composer Pro includes a programming environment called adaptive programming. This allows reasonably complex programs to be generated within the all compatible

drives. The drives contain adaptive programming for free, you only need the tool to access it. Adaptive programming allows logic or mathematics to be performed to enhance the parameter set, using a range of logic functions or arithmetic function blocks. Inside some of the drives the environment is further enhanced by the addition of sequence programming, where the program can be organised into steps that are triggered by certain events. Adaptive programming allows the drive to take the place of relays and PLCs around the drive, removing cost from the project. If adaptive programming is not sufficient, then upgrade to the CODESYS environment using Automation Builder in the drives that support it.

#### DriveManager for SIMATIC

Drive Manager for SIMATIC (DM4S-01) is a plug-in device tool that can be easily installed into the STEP 7 and TIA Portal. It utilises the TCI interface of the SIMATIC PLC to communicate



with the drives connected to PROFIBUS or PROFINET network. Drive Manager for SIMATIC offers features for the setup of ABB low voltage drives used with SIMATIC S7 PLCs

#### Automation Builder



Automation Builder is an integrated software suite for machine builders and system integrators wanting to automate their machines and systems in an integrated and efficient way.

Automation Builder is the successor of the PS501 Control Builder Plus product, incorporating all PLC engineering functionality plus additional engineering features.

#### DriveWindow Light

Available for ACx550, ACS310, ACS355 and ACS800 drives it has the similar functions as DriveWindow but is designed for point-to-point communication, via control panel port.



### Engineering tools

#### DriveSize

For dimensioning drives and motors this PC programme helps select an optimal motor, drive and transformer, which



is especially useful where a straightforward selection from a catalogue is not possible. DriveSize is used to compute network harmonics and to create documents about dimensioning. It contains current versions of ABB's motors and drives catalogues.

It can also be used in conjunction with ABB machinery drives to specify the dimensions of different kinds of linear or rotary movement mechanisms such as lead screws, rack and pinion combinations, belts and pulleys, conveyors, feed rolls and rotating tables.

DriveSize software can be used in Win98, WinNT, Win2000 and WinXP, Windows 7, Windows 8 operating systems.

#### DriveChopper



For dimensioning a braking chopper and resistor.

DriveChopper is a web tool for braking chopper and resistor dimensioning. The programme is created especially for system designers who need a braking unit for a particular drive application.

# Other drives, accessories and services

## Software tools

### DriveUpgrade

For finding an adequate drive to replace an old one. This on-line tool is ideal for finding a replacement to an existing ABB drive that may be coming to the end of its useful life. Simply input some basic information and the modern equivalent drive will be revealed.

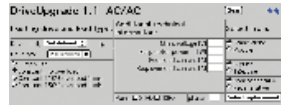

To download, go to: [www.abb.com](http://www.abb.com) > drives > drive PC tools.

### AVP energy toolkit app

Energy, CO<sub>2</sub> and money saved, together with an estimated return on investment, are the outputs of an app designed to show the benefits of using variable-speed drives (VSDs) and electric motors to replace direct-on-line starting.



The app produces an instant mini-report that contains details of a matched ABB motor-drive package and can be forwarded to one of ABB's authorised value providers.

To download the app, visit the Apple App Store on your iPhone or iPad and search AVP energy toolkit.

5

### Energy saving tools

For comparison of energy consumption between different flow control methods in pumps and fans, ABB has developed calculation tools for estimating the energy savings that become available when applying electric speed control to certain flow machines. ABB has smartphone Apps to help also.



ABB have also upgraded their popular Fansave and Pumpsave tools to a more modern platform. Savings for Fans pumps and compressors can now be calculated in a graphical Environment, please visit: <http://new.abb.com/drives/energy-efficiency/energysave-calculator> where links to the Appstore and WEB based tools can be accessed.

### Energy appraisal report web tool

This is a dedicated web tool to allow ABB's authorised value provider to generate energy appraisal reports, helps to save energy on applications.

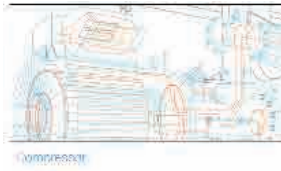
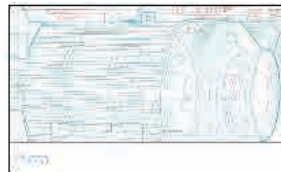
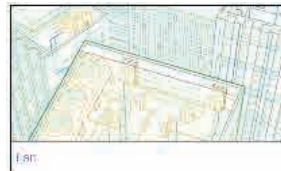
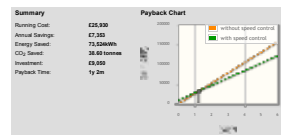

Equipment Required

Type Designation:	ACH500-01-075A-4
Rated Power:	37.000kW
Drive Range:	ABB HVAC drive
Drive Type:	AC variable speed drive (VSD) - 2 poles
EMC Compliance:	EN61800-3, CS (2nd em.) Option of C2 (F5)
Quantity:	2
Price including Installation:	£3,500

# Other drives, accessories and services

## Reliability Assessment, service and training

In the UK, it is estimated that over 80 percent of installed variable-speed drives are not maintained. The Reliability Assessment service helps to highlight this issue by preparing a report at a given site, which shows life cycle phase, maintenance history and recommended maintenance schedule.

### Total cost of ownership

Consider this:



The main challenge facing every motor-driven application is how to minimise the cost of not running. While rapid response to failures is one approach, it would be much easier if the risk of failure was minimised in the first place.

This is where Reliability Assessment service steps in. The cost of maintenance is always less than the cost of failure; therefore a structured maintenance/ replacement scheme drives down the total cost of ownership.

### Reliability Assessment

Maximising profit means that every part of your process is running uninterrupted, without surprises. Predictability saves time, cuts costs and ultimately, keeps your business effective.

With the Reliability Assessment service, you can combine the drives maintenance status with its criticality to the process or application. This provides the know-how to determine exactly where your process stands, now and in the future.

Reliability Assessments work by highlighting the most critical drives so clear priorities for maintenance are set. Service budgeting is optimised as the total plant's maintenance actions can be planned in advance. As a result, fewer unexpected interruptions occur. The ultimate aim: to always maximise reliability of the ABB drives installed base at a site and to manage the entire lifecycle, reducing downtime and production losses.

Taking ownership via some long term planning of maintenance and replacement through Reliability Assessments reduces total cost of ownership since cost of not running is minimised via maximising uptime.

Reliability Assessments are suitable for all drives, no matter what make or stage in their life cycle.

### How it works

#### Drive registration

Before any assessments can be done, every drive needs to be registered. During registration, the drive criticality can also be defined and customer identification and application data will be entered.

#### Getting started

ABB collects and prepares all applicable data on your drives, along with detailed service history and environment of the installation. Together with the insight of on-site professionals, we gather all the crucial data about your technical infrastructure.

#### Focusing on the detail

Details of each drive are analysed including age, location, business impact, effects of operating environment, service history, as well as all additional third party servicing and part replacements.

#### Analysing your maintenance plant

The Reliability Assessment service now combines the variables of each drive to paint a comprehensive picture of your entire technical infrastructure that allows you to define and review your maintenance plan.

#### Getting to know your facts

Finally, ABB provides you with an in-depth report that examines the current and future state of your factory or plant. Getting detailed information helps you plan future investments and maintenance better, with the related schedules, budgeting and execution. It also lets you tackle any imminent future defects in time.

#### ABB University - Professional drives training

Factory certified courses delivered in a bespoke drives training facility by experienced applications and service personnel. With ABB University you can enrol onto either e-learning or classroom based courses. Please call **01785 285939** or visit **[www.abb.co.uk/abbuniversity](http://www.abb.co.uk/abbuniversity)**

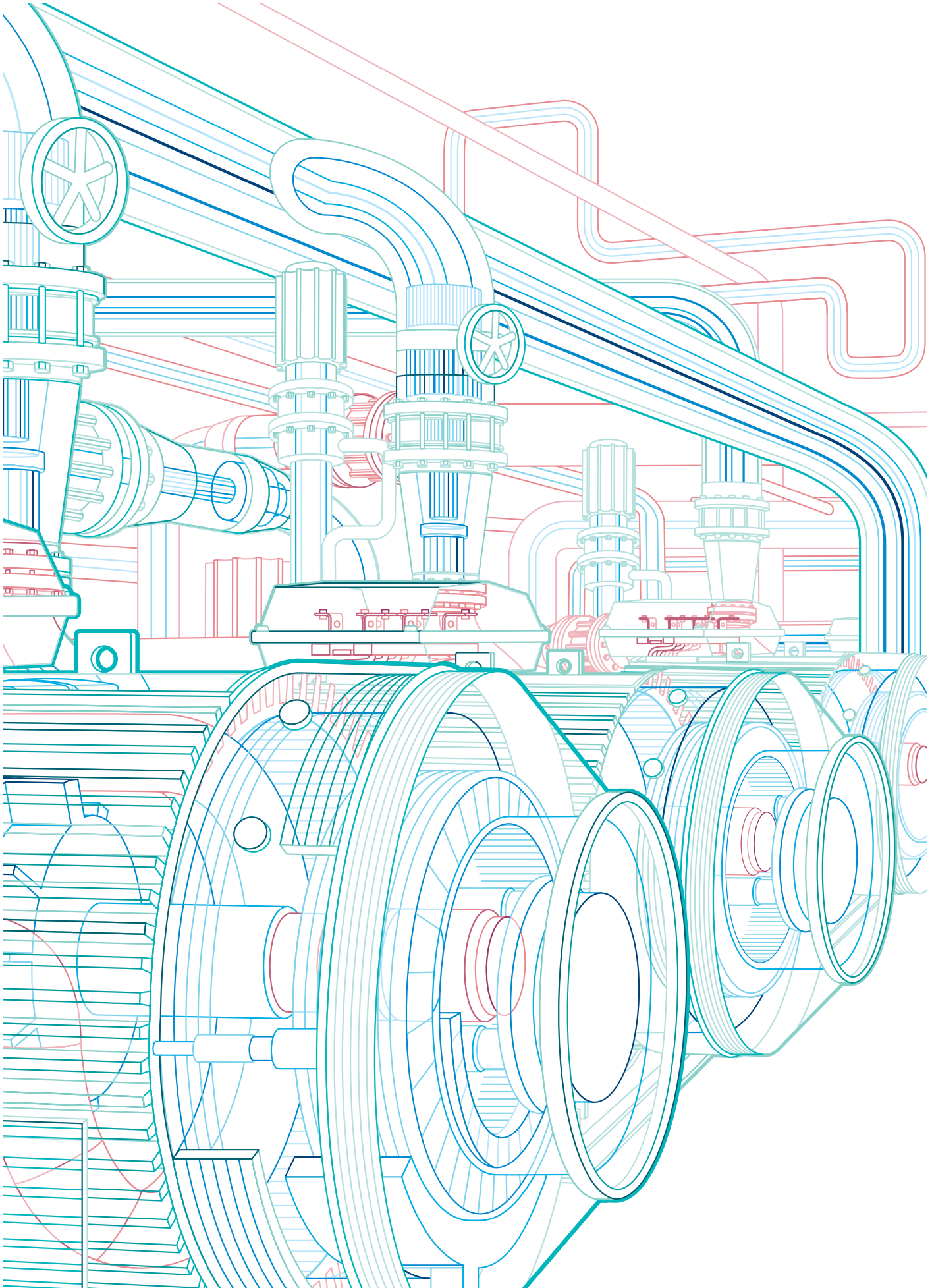

# AC motors

<a href="#">Low voltage AC motors - Sizings and ratings</a>	86
<a href="#">European MEPS for low voltage motors</a>	88
<a href="#">EU 4/2014 - main changes and exclusions</a>	89
<a href="#">Process performance motors</a>	90
<a href="#">General performance motors</a>	94
<a href="#">Explosive atmospheres</a>	96
<a href="#">Flameproof motors</a>	98
<a href="#">Optional extras for low voltage AC motors</a>	100
<a href="#">NEMA motors</a>	102
<a href="#">Central motor stock, Menden, Germany</a>	103
<a href="#">High voltage AC motor range</a>	104

# Low voltage AC motors

## Sizes and ratings

### Sizes 56-450

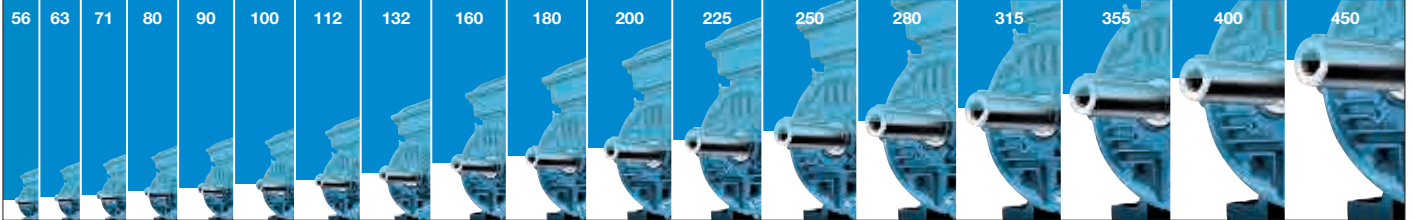

### General performance motors - page 95

56	63	71	80	90	100	112	132	160	180	200	225	250	280	315	355	400	450
IE2 aluminum motors																	
	IE2 cast iron motors																
	IE3 cast iron motors																

### Process performance motors - page 92

56	63	71	80	90	100	112	132	160	180	200	225	250	280	315	355	400	450
IE2 aluminium motors																	
	IE3 aluminium motors																
	IE2 cast iron motors																
	IE3 cast iron motors																
													IE4 cast iron motors				

### Motors for hazardous areas - page 98

56	63	71	80	90	100	112	132	160	180	200	225	250	280	315	355	400	450
		IE2 flameproof motor															
		IE3 flameproof motor															
	IE2 non-sparking motors																
	IE3 non-sparking motors																
	IE2 dust ignition protection motors																
	IE3 dust ignition protection motors																
		Increased safety motors															

### Marine motors

56	63	71	80	90	100	112	132	160	180	200	225	250	280	315	355	400	450
	Process performance motors (aluminium)																
	Process performance motors (cast iron)																
	General performance motors (aluminium, cast iron)																

### Motors for other applications

56	63	71	80	90	100	112	132	160	180	200	225	250	280	315	355	400	450	
	Brake motors																	
		High ambient motors																
	Smoke venting motors																	
Single phase motors								Roller table motors										
														Water-cooled motors				
														Permanent magnet motors				
															Wind turbine generators			
			High dynamic performance motors (HDP)															
		Synchronous reluctance motors (SynRM)																



# AC motors

## European Minimum Energy Performance Standards (EU MEPS)

2014

Regulation  
EU 4/2014  
introduced

2009

EuP Directive  
2005/32/EC  
Eco-design  
formally  
adopted  
EC 640/2009

### Mandatory EuP Directive

Applies to motors:

- rated voltage up to 1000 V
- single-speed, three-phase, 50 Hz
- 2, 4 and 6-pole
- rated output from 0.75 kW - 375 kW
- S1 Duty

Does not apply to motors designed to operate exclusively:

- in potentially explosive atmospheres as defined in ATEX directive 94/9/EC
- brake motors
- ambient air temperature outside the range -30°C to +60°C
- altitudes exceeding 4000m asl
- maximum operating air temperature above 400°C

### Implementation timetable

#### Phase 1

From 16 June, 2012

Motors must meet the IE2 efficiency level

#### Phase 2

From 1 January, 2015

Motors with a rated output of 7.5 kW - 375 kW must meet EITHER the IE3 efficiency level OR the IE2 level if fitted with variable-speed drive

#### Phase 3

From 1 January, 2017

Motors with a rated output of 0.75 kW - 375 kW must meet EITHER the IE3 efficiency level OR the IE2 level if fitted with variable-speed drive

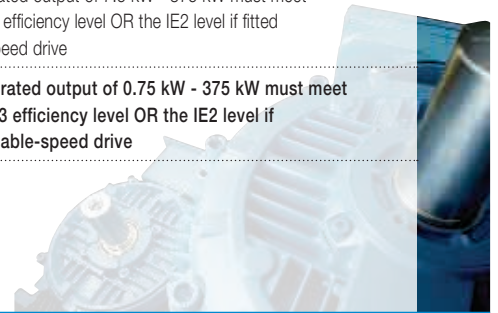

6

2008

IEC 60034-30

### Standard for LV motor efficiency classes

Motors covered by standard include:

- Single-speed, three-phase, 50 and 60 Hz
- 2, 4 or 6-pole
- Rated output from 0.75 kW - 375 kW
- Rated voltage  $U_n$  up to 1000 V
- Duty type S1 (continuous duty) or S3 (intermittent periodic duty) with a rated cyclic duration factor of 80 percent or higher
- Capable of operating direct online 50 and 60 Hz

### Super premium efficiency

IE4

Not yet defined

### Premium efficiency

IE3

Premium

### High efficiency

IE2

Comparable to Eff1

### Standard efficiency

IE1

Comparable to Eff2

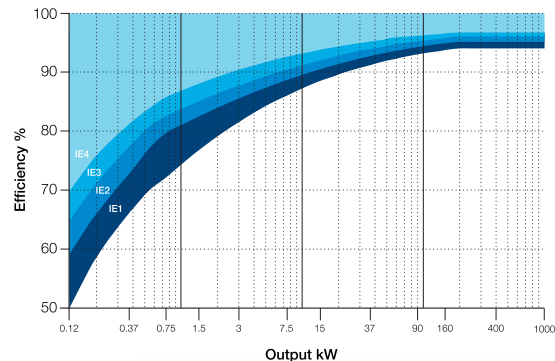

2007

IEC 60034-2-1

### Standard on efficiency measurement methods

Introduces new rules concerning the testing methods to be used for determining losses and efficiency.

The resulting efficiency values differ from those obtained under the previous IEC testing standard IEC 60034-2: 1996

ABB calculates efficiency values according to the indirect method, with additional losses determined from measurement. This is the preferred low uncertainty method outlined in the standard.

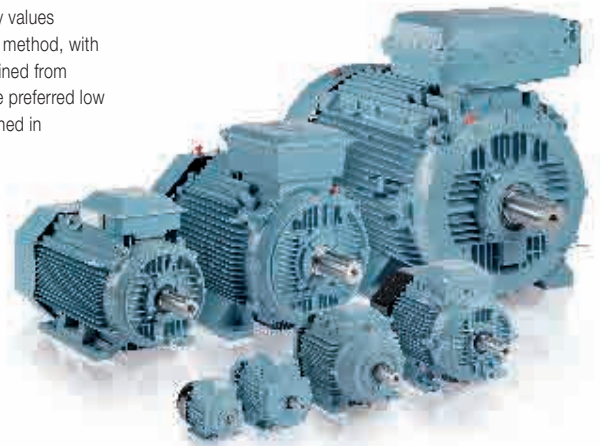



# AC motors

## EU 4/2014 - main changes and exclusions

### Original Regulation EC 640/2009



EU MEPS covers 2-, 4- and 6-pole single speed, three-phase induction motors in a power range of 0.75 kW - 375 kW rated up to 1000 V. It covers all duty types as long as the motors are capable of continuous duty operation.

### Amending Regulation EU 4/2014

The amending regulation came into force in mid-2014 and was intended to close loopholes in the original regulation. The amendment was issued after it became clear that certain manufacturers were intentionally contravening the spirit of EU MEPS.

The amendment did not change the scope of EU MEPS, but instead clarified the original spirit of Regulation EC 640. The main changes are shown below.

The original Regulation excluded the following motors from the scope of EU MEPS:		
motors designed to operate wholly immersed in a liquid	change	specified to operate
motors completely integrated into a product where the motor's energy performance cannot be tested independently from the product		no change
motors specifically designed to operate continuously:	change	specified to operate exclusively
at altitudes exceeding 1000 meters ASL	change	4000 m
outside the ambient air temperature range of -15°C ... +40°C	change	-30°C ... +60°C
where ambient air temperatures are less than -15 °C for any motor or less than 0 °C for a motor with air cooling	change	water cooling
in maximum operating temperatures above 400°C		no change
where the water coolant temperature at the inlet to a product is less than 5°C or exceeds 25°C	change	0°C ... 32°C
in potentially explosive atmospheres as defined in Directive 94/9/EC		no change
brake motors		no change
Requirements for markings on motor rating plates:		
manufacturers must mark efficiency at 100%, 75% and 50% of rated load	change	In the case of small motors (ie, where the rating plate is small) only the efficiency for 100% rated load to be shown

# Low voltage AC motors

## Process performance motors

What is a process performance motor?

Process performance motors are the flagship of ABB's standard low voltage motors. This range provides the most comprehensive, versatile set of motors for the process industries and heavy-duty applications which are dependent on continuous reliability, lowest possible environmental impact and life cycle costs. Their superior ability to perform reliably and efficiently, continuously and even under the most challenging circumstances, ensures that they power their way through the toughest tasks and conditions.

6



Where can it be used?

- End-users in continuous process industries
- Project OEMs
- Demanding industries:
  - pulp and paper
  - metals
  - minerals and mining

Highlights

- All variant codes possible for process industry
- Application knowledge and engineering
- With three years warranty and option to extend to five years
- IE3 and IE4

# Low voltage AC motors

## Process performance cast iron motors

### 80-355, 2, 4 & 6 poles

TEFC low voltage motors, cast iron, IP55, IC 411, single-speed. 400 V 3-phase 50 Hz  
See product catalogues or [www.abb.com/motors&generators](http://www.abb.com/motors&generators) for more information on products.

Output kW	Torque Nm	Current I	Eff*	Frame size	Foot price	Flange price
<b>3000 r/min = 2 poles</b>						
0.37	1.29	0.94	73.8	M3BP 71MC 2	£260	£306
0.55	1.91	1.25	77.8	M3BP 71ME 2	£292	£338
0.75	2.5	1.6	80.7	M3BP 80MC 2	£402	£446
1.1	3.7	2.3	82.7	M3BP 80ME 2	£422	£465
1.5	4.9	2.9	84.2	M3BP 90SLA 2	£444	£491
2.2	7.2	4.2	85.9	M3BP 90LA 2	£552	£597
3	9.9	5.4	87.1	M3BP 100MLA 2	£649	£721
4	13.3	6.9	88.1	M3BP 112ME 2	£834	£936
5.5	18.1	9.8	89.2	M3BP 132SMC 2	£1,010	£1,094
7.5	24.6	13.3	90.1	M3BP 132SME 2	£1,218	£1,329
11	36	18.7	92.1	M3BP 160MLA 2	£1,349	£1,486
15	49	25.4	92.5	M3BP 160MLB 2	£1,603	£1,748
18.5	60	30.8	93.1	M3BP 160MLC 2	£1,957	£2,085
22	71	37.4	93.2	M3BP 180MLA 2	£2,363	£2,472
30	97	51	94.2	M3BP 200MLA 2	£3,033	£3,160
37	119	61.9	94.7	M3BP 200MLB 2	£4,416	£4,597
45	145	76.8	94.9	M3BP 225SMA 2	£5,590	£5,787
55	177	93.6	95.2	M3BP 250SMA 2	£6,630	£6,849
75	240	129	95.5	M3BP 280SMB 2	£8,395	£8,876
90	288	153	95.7	M3BP 280SMC 2	£9,557	£9,847
110	352	189	95.9	M3BP 315SMB 2	£12,589	£13,002
132	422	226	96.1	M3BP 315SMC 2	£13,917	£14,344
160	512	268	96.2	M3BP 315MLA 2	£15,905	£16,336
200	640	334	96.4	M3BP 315MLB 2	£22,142	£24,296
200	640	336	96.4	M3BP 355SMA 2	£22,142	£24,296
250	801	413	96.4	M3BP 315LKB 2	£28,018	£29,390
250	800	415	96.4	M3BP 355SMB 2	£28,018	£29,390
315	1008	533	96.4	M3BP 355SMC 2	£35,266	£36,639
355	1137	595	96.4	M3BP 355MLA 2	£39,775	£41,146

Output kW	Torque Nm	Current I	Eff*	Frame size	Foot price	Flange price
<b>1500 r/min = 4 poles</b>						
0.25	1.69	0.6	73.5	M3BP 71MD 4	£252	£299
0.37	2.5	0.9	77.3	M3BP 71MLE 4	£283	£331
0.55	3.6	1.2	80.8	M3BP 80MLC 4	£378	£425
0.75	4.9	1.7	82.5	M3BP 80MLE 4	£386	£430
1.1	7.3	2.4	84.1	M3BP 90LA 4	£422	£465
1.5	9.9	3.3	85.3	M3BP 90LB 4	£509	£554
2.2	14.5	4.5	86.7	M3BP 100LA 4	£577	£649
3	19.8	6.1	87.7	M3BP 100MLB 4	£656	£735
4	26.3	8.9	88.6	M3BP 112ME 4	£815	£878
5.5	36	11.9	89.6	M3BP 132SMB 4	£1,037	£1,110
7.5	49	15.7	90.4	M3BP 132SME 4	£1,277	£1,350
11	71	20.4	92.2	M3BP 160MLA 4	£1,339	£1,473
15	97	27.8	92.6	M3BP 160MLB 4	£1,667	£1,833
18.5	119	34.9	93.3	M3BP 180MLA 4	£1,978	£2,105
22	142	41.5	93.3	M3BP 180MLB 4	£2,363	£2,453
30	193	54.6	94.4	M3BP 200MLA 4	£3,070	£3,235
37	238	65.4	94.9	M3BP 225SMA 4	£4,091	£4,308
45	290	80.2	95.2	M3BP 225SMB 4	£4,794	£5,030
55	354	97.8	95.4	M3BP 250SMA 4	£5,734	£6,006
75	482	134	95.9	M3BP 280SMB 4	£7,157	£7,587
90	578	161	96	M3BP 280SMC 4	£8,591	£9,040
110	704	194	96.2	M3BP 315SMC 4	£10,600	£11,067
132	846	234	96.3	M3BP 315SMD 4	£12,519	£12,948
160	1025	278	96.5	M3BP 315MLB 4	£14,632	£15,062
200	1282	344	96.6	M3BP 315LKB 4	£20,798	£21,336
200	1281	345	96.6	M3BP 355SMA 4	£20,798	£21,336
250	1602	430	96.6	M3BP 315LKC 4	£24,561	£25,279
250	1601	433	96.6	M3BP 355SMB 4	£24,561	£25,279
315	2019	554	96.6	M3BP 355SMC 4	£32,627	£33,703
355	2274	616	96.6	M3BP 355MLA 4	£34,780	£35,852

Output kW	Torque Nm	Current I	Eff*	Frame size	Foot price	Flange price
<b>1000 r/min = 6 poles</b>						
0.18	1.94	0.57	63.9	M3BP 71ME 6	£271	£318
0.25	2.5	0.82	68.6	M3BP 80MB 6	£331	£386
0.37	3.8	1.06	73.5	M3BP 80MC 6	£381	£427
0.55	5.6	1.52	77.2	M3BP 80ME 6	£385	£428
0.75	7.6	1.8	78.9	M3BP 90SLD 6	£425	£466
1.1	11.1	2.6	81	M3BP 90LF 6	£509	£554
1.5	14.9	3.8	82.5	M3BP 100MLB 6	£632	£699
2.2	21.6	4.5	84.3	M3BP 112MJ 6	£779	£849
3	29.1	6.9	85.6	M3BP 132SMB 6	£1,010	£1,087
4	39	10.7	86.8	M3BP 132SMF 6	£1,145	£1,215
5.5	54	12.3	88	M3BP 132SMJ 6	£1,237	£1,313
7.5	73	15.2	90.8	M3BP 160MLA 6	£1,332	£1,464
11	107	23.5	91.2	M3BP 160MLB 6	£1,940	£2,079
15	146	30.4	92.2	M3BP 180MLA 6	£2,363	£2,528
18.5	178	37.3	92.8	M3BP 200MLA 6	£2,795	£2,981

Output kW	Torque Nm	Current I	Eff*	Frame size	Foot price	Flange price
<b>1000 r/min = 6 poles</b>						
22	212	43	93.3	M3BP 200MLB 6	£3,106	£3,309
30	290	56.8	94.1	M3BP 225SMA 6	£4,834	£5,066
37	357	68	94.4	M3BP 250SMA 6	£5,610	£5,863
45	433	80.9	94.7	M3BP 280SMB 6	£8,145	£8,412
55	531	99.4	95	M3BP 280SMC 6	£8,863	£9,149
75	720	138	95.3	M3BP 315SMC 6	£10,903	£11,354
90	865	170	95.5	M3BP 315SMD 6	£12,820	£13,502
110	1057	202	95.7	M3BP 315MLB 6	£15,583	£16,264
132	1269	243	95.9	M3BP 315LKA 6	£19,186	£20,440
160	1537	293	96.1	M3BP 315LKC 6	£21,873	£23,129
160	1536	294	96.1	M3BP 355SMB 6	£21,873	£23,129
200	1919	367	96.2	M3BP 355SMC 6	£27,249	£28,503
250	2399	456	96.4	M3BP 355MLB 6	£33,703	£34,958
315	3026	576	96.5	M3BP 355LKA 6	£40,514	£41,768
355	3407	668	96.5	M3BP 355LKB 6	£48,223	£49,477

\* Efficiency full load 100%

# Low voltage AC motors

IE3

## Process performance aluminium motors

80-250, 2, 4 & 6 poles

TEFC low voltage motors, aluminium, IP55, IC 411, single-speed. 400 V 3-phase 50 Hz  
See product catalogues or [www.abb.com/motors&generators](http://www.abb.com/motors&generators) for more information on products.

Output kW	Torque Nm	Current I	Eff*	Frame size	Foot price	Flange price
<b>3000 r/min = 2 poles</b>						
0.75	2.5	1.7	80.7	M3AA 80B 2	£241	£278
1.1	3.7	2.4	82.7	M3AA 80C 2	£266	£296
1.5	4.9	3	84.4	M3AA 90L 2	£311	£351
2.2	7.2	4.7	85.9	M3AA 90LB 2	£394	£433
3	9.9	5.4	87.5	M3AA 100LB 2	£467	£513
4	13.3	7.2	88.5	M3AA 112MB 2	£555	£613
5.5	18	9.9	89.2	M3AA 132SB 2	£723	£796
7.5	24.7	13	90.5	M3AA 132SC 2	£900	£970
11	36	18.7	92.1	M3AA 160MLA 2	£1,333	£1,446
15	49	25.4	92.5	M3AA 160MLB 2	£1,732	£1,860
18.5	60	30.8	93.1	M3AA 160MLC 2	£2,078	£2,205
22	71	37.4	93.2	M3AA 180MLA 2	£2,370	£2,533
30	97	51	94.2	M3AA 200MLA 2	£2,990	£3,170
37	119	61.9	93.7	M3AA 200MLB 2	£3,900	£4,118
45	145	76.8	94.9	M3AA 225SMA 2	£5,611	£5,852
55	177	93.6	95.2	M3AA 250SMA 2	£6,564	£6,827
75	241	127	94.7	M3AA 280SMA 2	£8,103	£8,313
90	289	149	95	M3AA 280SMB 2	£9,493	£9,743

Output kW	Torque Nm	Current I	Eff*	Frame size	Foot price	Flange price
<b>1500 r/min = 4 poles</b>						
0.75	5	1.9	82.5	M3AA 80ME 4	£250	£281
1.1	7.3	2.5	84.1	M3AA 90LB 4	£287	£324
1.5	9.9	3.3	85.3	M3AA 90LD 4	£339	£385
2.2	14.4	4.6	86.7	M3AA 100LC 4	£412	£458
3	19.8	5.9	87.9	M3AA 100LD 4	£491	£546
4	26.3	8.6	88.6	M3AA 112MB 4	£583	£638
5.5	36	11	89.6	M3AA 132M 4	£744	£815
7.5	49	15.6	90.6	M3AA 132MA 4	£943	£1,028
11	71	20.4	92.2	M3AA 160MLA 4	£1,360	£1,473
15	97	27.8	92.6	M3AA 160MLB 4	£1,765	£1,876
18.5	119	34.9	93.3	M3AA 180MLA 4	£2,005	£2,168
22	142	41.5	93.3	M3AA 180MLB 4	£2,407	£2,570
30	193	54.6	94.4	M3AA 200MLA 4	£3,098	£3,317
37	238	65.4	94.9	M3AA 225SMA 4	£3,941	£4,218
45	290	80.2	95.2	M3AA 225SMB 4	£4,796	£5,075
55	354	97.8	95.4	M3AA 250SMA 4	£5,730	£5,968
75	483	138	95	M3AA 280SMA 4	£7,347	£7,599

Output kW	Torque Nm	Current I	Eff*	Frame size	Foot price	Flange price
<b>1000 r/min = 6 poles</b>						
0.75	7.7	2.1	78.9	M3AA 90LB 6	£315	£345
1.1	11.3	2.7	81	M3AA 90LD 6	£388	£412
1.5	14.9	3.6	84.7	M3AA 100LC 6	£443	£485
2.2	22	5.9	84.3	M3AA 112MB 6	£555	£592
3	29.5	7.4	85.6	M3AA 132S 6	£693	£741
4	40	8.9	86.8	M3AA 132MA 6	£860	£903
5.5	54	13.3	88.5	M3AA 132MC 6	£1,065	£1,095
7.5	73	15.2	90.8	M3AA 160MLA 6	£1,446	£1,559
11	107	23.5	91.2	M3AA 160MLB 6	£1,969	£2,078
15	145	30.4	92.2	M3AA 180MLA 6	£2,461	£2,625
18.5	178	37.3	92.8	M3AA 200MLA 6	£2,953	£3,171
22	212	43	93.3	M3AA 200MLB 6	£3,482	£3,700
30	290	56.8	94.1	M3AA 225SMA 6	£4,877	£5,115
37	357	68	94.4	M3AA 250SMA 6	£5,796	£6,087
45	434	85.5	93.7	M3AA 280SMA 6	£6,791	£7,040
55	531	105	94.1	M3AA 280SMB 6	£8,306	£8,765

\* Efficiency full load 100%



# Low voltage AC motors

## General performance motors

What is a general performance motor?  
These motors combine convenience and easy handling seamlessly with ABB's engineering expertise, while at the same time providing standard variants and modifications. The motors can be tailored according to the specific needs of OEMs. The high modularity enables adding a wide variety of elements to the robust frame, thus making the overall solution to fit the specific situation and customer need perfectly. As the user only pays for the enhancements needed and used, the motors are free from all unnecessary elements.

### Highlights

- Variant codes which OEM customers need
- One year warranty
- IE3
- 2, 4 & 6 pole

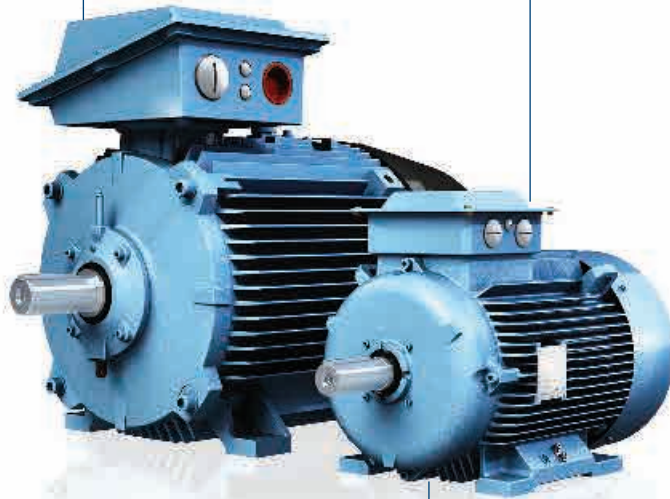

### Where can it be used?

- End-users in various industries
- Tailored serial project OEM
- Pumps
- Fans
- Compressors

# Low voltage AC motors

## General performance cast iron motors

### 132-355, 2, 4 & 6 poles

IE3

TEFC low voltage motors, cast iron, IP55, IC 411, single-speed. 400 V 3-phase 50 Hz  
See product catalogues or [www.abb.com/motors&generators](http://www.abb.com/motors&generators) for more information on products.

Output kW	Torque Nm	Current I	Eff*	Frame size	Foot price	Flange price
<b>3000 r/min = 2 poles</b>						
0.37	1.25	0.87	76.5	M2BAX 71MC 2	£173	£189
0.55	1.87	1.27	78.4	M2BAX 71MB 2	£178	£199
0.75	2.5	1.68	80.7	M2BAX 80MC 2	£235	£256
1.1	3.7	2.3	82.7	M2BAX 80MD 2	£297	£341
1.5	4.9	3.1	84.2	M2BAX 90SB 2	£352	£398
2.2	7.2	4.6	85.9	M2BAX 90SLA 2	£436	£481
3	9.8	5.5	87.1	M2BAX 100LKA 2	£531	£589
4	13.2	7.3	88.1	M2BAX 112MB 2	£627	£688
5.5	17.9	10.8	89.2	M2BAX 132SMA 2	£822	£900
7.5	24.7	13.2	90.1	M2BAX 132SME 2	£1,042	£1,124
11	36	19.1	91.2	M2BAX 160MLA 2	£1,088	£1,190
15	49	26.8	91.9	M2BAX 160MLB 2	£1,385	£1,484
18.5	60	32.1	92.4	M2BAX 160MLC 2	£1,646	£1,745
22	71	38.1	92.7	M2BAX 180MLA 2	£1,940	£2,093
30	97	52.8	93.3	M2BAX 200MLA 2	£2,621	£2,824
37	119	64.1	93.7	M2BAX 200MLB 2	£3,232	£3,435
45	145	79.5	94	M2BAX 225SMA 2	£3,751	£3,985
55	177	94.2	94.3	M2BAX 250SMA 2	£4,543	£4,807
75	241	130	94.7	M2BAX 280SMB 2	£6,807	£7,174
90	289	155	95	M2BAX 280SMC 2	£8,186	£8,554
110	352	192	95.2	M2BAX 315SMB 2	£9,970	£10,595
132	423	230	95.4	M2BAX 315SMC 2	£12,048	£12,674
160	512	278	95.6	M2BAX 315SMD 2	£14,954	£15,579
200	640	343	95.8	M2BAX 315MLA 2	£18,762	£19,387
250	800	423	95.8	M2BAX 355SMA 2	£23,765	£24,868
315	1009	533	95.8	M2BAX 355SMB 2	£29,870	£31,003
355	1136	608	95.8	M2BAX 355SMC 2	£33,475	£34,608

Output kW	Torque Nm	Current I	Eff*	Frame size	Foot price	Flange price
<b>1500 r/min = 4 poles</b>						
0.25	1.66	0.76	73.5	M2BAX 71MB 4	£160	£181
0.37	2.5	1.05	77.3	M2BAX 71MLA 4	£170	£203
0.55	3.6	1.33	80.8	M2BAX 80MC 4	£203	£235
0.75	5	1.87	82.5	M2BAX 80MLA 4	£290	£319
1.1	7.3	2.6	84.1	M2BAX 90SB 4	£364	£402
1.5	10	3.5	85.3	M2BAX 90SLA 4	£436	£474
2.2	14.5	4.7	86.7	M2BAX 100LB 4	£495	£551
3	19.8	6.3	87.7	M2BAX 100LKA 4	£555	£611
4	26.5	8	88.6	M2BAX 112MLA 4	£662	£723
5.5	36	11.5	89.6	M2BAX 132SMA 4	£847	£924
7.5	49	15.4	90.4	M2BAX 132SME 4	£1,087	£1,168
11	71	21.2	91.4	M2BAX 160MLA 4	£1,125	£1,224
15	97	28.7	92.1	M2BAX 160MLB 4	£1,433	£1,533
18.5	119	34.8	92.6	M2BAX 180MLA 4	£1,631	£1,785
22	142	41.7	93	M2BAX 180MLB 4	£1,940	£2,093
30	193	55.1	93.6	M2BAX 200MLA 4	£2,525	£2,726
37	238	68.6	93.9	M2BAX 225SMA 4	£3,085	£3,318
45	290	82.1	94.2	M2BAX 225SMB 4	£3,751	£3,985
55	354	100	94.6	M2BAX 250SMA 4	£4,543	£4,807
75	482	133	95	M2BAX 280SMB 4	£6,585	£6,953
90	579	159	95.2	M2BAX 280SMC 4	£7,689	£8,076
110	705	196	95.4	M2BAX 315SMB 4	£9,547	£10,172
132	847	232	95.6	M2BAX 315SMC 4	£11,515	£12,140
160	1027	284	95.8	M2BAX 315SMD 4	£13,924	£14,549
200	1284	350	96	M2BAX 315MLB 4	£17,676	£18,302
250	1601	437	96	M2BAX 355SMA 4	£22,054	£23,139
315	2017	550	96	M2BAX 355SMB 4	£28,325	£29,458
355	2275	621	96	M2BAX 355SMC 4	£31,930	£33,063

Output kW	Torque Nm	Current I	Eff*	Frame size	Foot price	Flange price
<b>1000 r/min = 6 poles</b>						
0.18	1.85	0.59	63.9	M2BAX 71MB 6	£184	£209
0.25	2.6	0.78	68.6	M2BAX 71MLA 6	£211	£237
0.37	3.8	1.1	73.5	M2BAX 80MC 6	£232	£262
0.55	5.6	1.51	77.2	M2BAX 80MLA 6	£259	£294
0.75	7.5	2.3	78.9	M2BAX 90SLA 6	£272	£306
1.1	11	3.2	81	M2BAX 90LB 6	£320	£359
1.5	15	4	82.5	M2BAX 100LKA 6	£401	£446
2.2	22	5.8	84.3	M2BAX 112MLA 6	£540	£589
3	29.6	7.4	85.6	M2BAX 132SMA 6	£709	£758
4	39	10.2	86.8	M2BAX 132SMB 6	£771	£841
5.5	54	13.5	88	M2BAX 132MLA 6	£1,026	£1,067
7.5	73	15.8	89.1	M2BAX 160MLA 6	£1,162	£1,263
11	108	22.6	90.3	M2BAX 160MLB 6	£1,559	£1,658
15	146	30.1	91.2	M2BAX 180MLA 6	£2,009	£2,161
18.5	179	35.5	91.7	M2BAX 200MLA 6	£2,455	£2,657
22	212	42.5	92.2	M2BAX 200MLB 6	£2,919	£3,121
30	291	55.5	92.9	M2BAX 225SMA 6	£3,847	£4,081
37	357	71.5	93.3	M2BAX 250SMA 6	£4,584	£4,849
45	434	82.6	93.7	M2BAX 280SMB 6	£6,016	£6,402
55	529	98.1	94.1	M2BAX 280SMC 6	£7,358	£7,725
75	721	136	94.6	M2BAX 315SMB 6	£9,860	£10,485
90	865	163	94.9	M2BAX 315SMC 6	£11,845	£12,472
110	1058	201	95.1	M2BAX 315SMD 6	£14,403	£15,028
132	1268	244	95.4	M2BAX 315MLB 6	£17,198	£17,824
160	1540	294	95.6	M2BAX 355SMA 6	£21,263	£22,367
200	1925	368	95.8	M2BAX 355SMB 6	£26,780	£27,913
250	2404	465	95.8	M2BAX 355SMC 6	£32,960	£34,093

\* Efficiency full load 100%

# Low voltage AC motors

## Explosive atmospheres

There are systems in place worldwide to classify explosive atmospheres by zones, according to the risk posed by explosive gas ("G") or dust ("D").



6

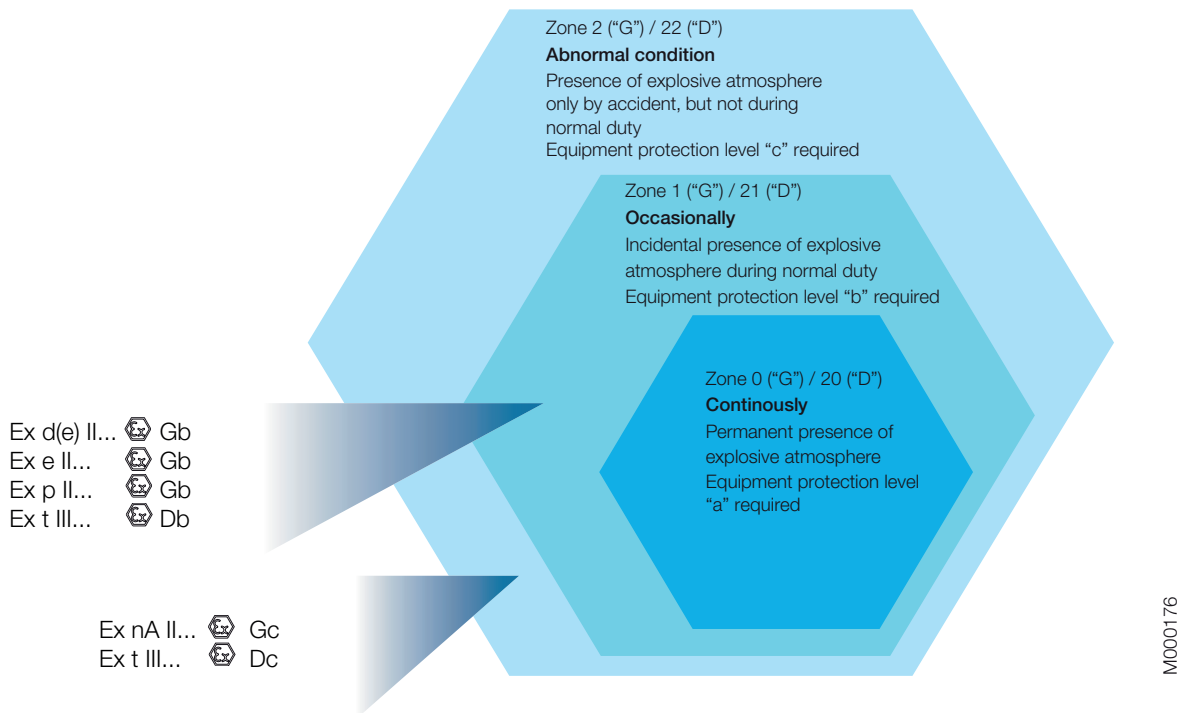

### Classification of explosive atmospheres according to CENELEC and IEC

The following standards define areas according to the presence of gas or dust in the atmosphere:

- IEC/EN 60079-10-1 Gas
- IEC/EN 60079-10-2 Dust

Standard IEC 60079-0 EN 60079-0			Installation Zone acc. to IEC 60079-10-x EN 60079-10-x Zones	Atex Directive 94/9/EC	Main motor Protection Types	
Group	EPL	Protection level		Equipment group	Equipment category	
I (Mines)	Ma	very high	NA	I (Mines)	M1	NA
	Mb	high			M2	
II (Gas)	Ga	very high	0	II (Surface)	1G	NA
	Gb	high	1		2G	Ex d/Ex de, Ex p, Ex e
	Gc	enhanced	2		3G	Ex nA
III (Dust)	Da	very high	20		1D	NA
	Db	high	21		2D	Ex tb IP 65
	Dc	enhanced	22		3D	Ex tc, IP 65/IP 55



# Low voltage AC motors

## Explosive atmospheres

To ensure equipment can be safely used in potentially explosive atmospheres, the explosive atmospheres where the equipment is installed must be known. The temperature class of equipment must be compared with the spontaneous

ignition the equipment of the gas mixtures concerned, and in specific cases the gas group must be known (e.g. flame proof protection).

### Gas classification

Temperature class	Ignition temp. of gas/vapour °C	Max. permitted temp. of equipment °C	Gas examples
T1	>450	450	Hydrogen
T2	>300 <450	300	Ethanol
T3	>200 <300	200	Hydrogen sulfide
T4	>135 <200	135	Diethyl ether
T5	>100 <135	100	-
T6	>85 <100	85	Carbon disulfide

### Gas subdivision

IIA	- 120 gases and vapours, e.g. butane/petroleum/propane
IIB	- 30 gases and vapours, e.g. ethylene/dimethyl ether/coke oven gas
IIC	three gases: hydrogen H <sub>2</sub> /acetylene C <sub>2</sub> H <sub>2</sub> carbon disulfide CS <sub>2</sub>

### Marking of equipment protection for gas according to ATEX

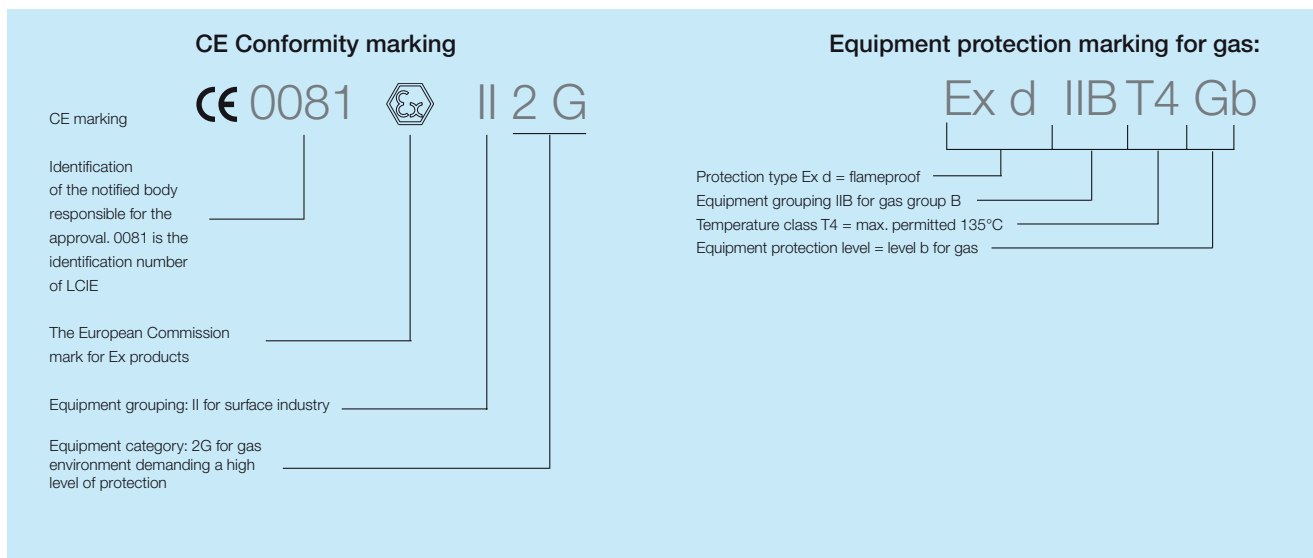

### Marking of equipment protection for gas according to IEC

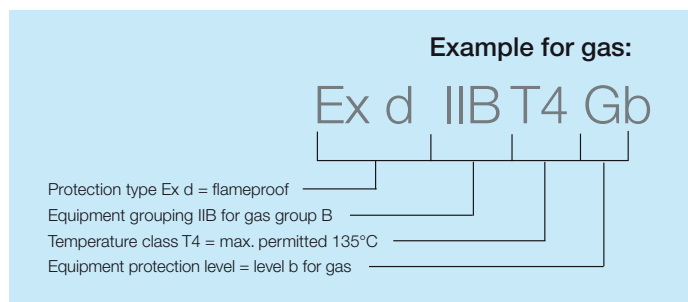

# Low voltage AC motors

## Flameproof motors 80-400, 2 & 4 poles

### Exd/e\* IIB T4

IE2

**ATEX**  
Certified

TEFC low voltage motors, cast iron, IP55, IC 411, single-speed. 400 V 3-phase 50 Hz  
See product catalogues or [www.abb.com/motors&generators](http://www.abb.com/motors&generators) for more information on products.

Output kW	Torque Nm	Current I	Eff <sup>†</sup>	Frame size	Foot price	Flange price
<b>3000 r/min = 2 poles</b>						
0.75	2.5	1.59	80.1	M3JP/KP 80MA 2	£771	£820
1.1	3.7	2.2	81.6	M3JP/KP 80MB 2	£808	£885
1.5	5	3	82	M3JP/KP 90SLA 2	£893	£969
2.2	7.3	4.3	83.7	M3JP/KP 90SLC 2	£1,059	£1,126
3	9.9	5.7	84.6	M3JP/KP 100LA 2	£1,121	£1,197
4	13.2	7.5	86	M3JP/KP 112MB 2	£1,393	£1,485
5.5	18.1	10.3	87	M3JP/KP 132SMB 2	£1,619	£1,701
7.5	24.6	13.5	89.2	M3JP/KP 132SMD 2	£2,062	£2,130
9.2	31	16.7	86.9	M3JP/KP 132SME 2	£2,505	£2,577 HO
11	36	19.9	90.1	M3JP/KP 160MLA 2	£2,385	£2,555
15	49	26.8	91.2	M3JP/KP 160MLB 2	£2,826	£2,946
18.5	60	32.4	91.6	M3JP/KP 160MLC 2	£3,215	£3,302
22	72	38.7	91.2	M3JP/KP 160MLD 2	£3,742	£3,863 HO
22	72	38.7	91.7	M3JP/KP 180MLA 2	£3,982	£4,117
30	97	52.3	92.5	M3JP/KP 180MLB 2	£4,745	£4,882 HO
30	97	53	92.8	M3JP/KP 200MLA 2	£5,069	£5,272
37	120	64.3	92.8	M3JP/KP 180MLC 2	£6,642	£6,896 HO
37	120	64.1	93.6	M3JP/KP 200MLC 2	£6,735	£7,039
45	146	78.8	93.3	M3JP/KP 200MLE 2	£8,585	£8,964 HO
45	145	79.4	93.8	M3JP/KP 225SMB 2	£9,112	£9,451
55	177	96	93.9	M3JP/KP 225SMC 2	£11,254	£11,679 HO
55	177	94.6	94.3	M3JP/KP 250SMA 2	£11,984	£12,426
67	216	120	93.9	M3JP/KP 225SMD 2	£12,730	£13,514 HO
75	241	129	93.8	M3JP/KP 250SMB 2	£15,177	£15,704 HO
75	241	131	94.3	M3JP/KP 280SMA 2	£14,000	£14,416
90	290	154	94.4	M3JP/KP 250SMC 2	£16,979	£18,063 HO
90	289	154	94.6	M3JP/KP 280SMB 2	£16,231	£16,650
110	353	186	95.1	M3JP/KP 280SMC 2	£19,174	£19,524 HO
110	352	196	94.9	M3JP/KP 315SMA 2	£21,444	£22,139
132	423	228	95.1	M3JP/KP 315SMB 2	£26,497	£27,195
160	513	272	95.4	M3JP/KP 315SMC 2	£32,597	£33,297
200	641	335	95.7	M3JP/KP 315MLA 2	£36,083	£36,782
250	800	423	95.7	M3JP/KP 355SMA 2	£44,450	£45,671
315	1009	534	95.7	M3JP/KP 355SMB 2	£54,214	£55,258
355	1136	608	95.7	M3JP/KP 355SMC 2	£58,049	£59,267
400	1281	677	96.9	M3JP/KP 355MLA 2	£64,496	£65,717
450	1441	743	97.1	M3JP/KP 355MLB 2	£72,167	£73,388
500	1601	832	96.9	M3JP/KP 355LKA 2	£84,019	£85,240
560	1790	934	97.2	M3JP/KP 400LA 2	£93,956	£95,699
560	1790	934	97.2	M3JP/KP 400LKA 2	£93,956	£95,699
630	2014	1044	97.4	M3JP/KP 400LB 2	£102,844	£104,587
630	2014	1044	97.4	M3JP/KP 400LKB 2	£102,844	£104,587
710	2270	1175	97.5	M3JP/KP 400LC 2	£115,745	£117,488
710	2270	1175	97.5	M3JP/KP 400LKC 2	£115,745	£117,488

Output kW	Torque Nm	Current I	Eff <sup>†</sup>	Frame size	Foot price	Flange price
<b>1500 r/min = 4 poles</b>						
0.55	3.7	1.43	76.6	M3JP/KP 80MA 4	£705	£771
0.75	5.1	1.81	80.2	M3JP/KP 80MB 4	£737	£808
1.1	7.3	2.5	82.2	M3JP/KP 90SLA 4	£784	£853
1.5	10.1	3.3	83.2	M3JP/KP 90SLC 4	£863	£936
2.2	14.6	4.4	85.5	M3JP/KP 100LA 4	£940	£1,017
3	19.8	6	86.5	M3JP/KP 100LB 4	£1,224	£1,297
4	26.2	8.4	88.2	M3JP/KP 112MC 4	£1,307	£1,403
5.5	36	11.1	89.5	M3JP/KP 132SMB 4	£1,730	£1,826
7.5	49	16	89.2	M3JP/KP 132SMD 4	£1,924	£2,028
9.2	61	18.8	88.4	M3JP/KP 132SME 4	£2,523	£2,595 HO
11	71	21.2	91.2	M3JP/KP 160MLC 4	£2,400	£2,520
15	98	28	92	M3JP/KP 160MLE 4	£2,976	£3,082
18.5	120	35.1	91.8	M3JP/KP 160MLF 4	£3,505	£3,607 HO
18.5	120	35.1	91.6	M3JP/KP 180MLA 4	£3,726	£3,879
22	143	43.2	90.8	M3JP/KP 160MLG 4	£3,927	£4,066 HO
22	143	42	92.2	M3JP/KP 180MLB 4	£4,135	£4,287
30	195	57.8	92.1	M3JP/KP 180MLC 4	£4,847	£4,983 HO
30	195	55.7	92.5	M3JP/KP 200MLB 4	£5,172	£5,359
37	240	69.7	93	M3JP/KP 200MLC 4	£5,901	£6,107 HO
37	239	67.1	93.6	M3JP/KP 225SMB 4	£6,362	£6,600
45	291	80.8	93.8	M3JP/KP 225SMC 4	£7,516	£7,770
55	354	101	94.3	M3JP/KP 225SMD 4	£8,704	£9,128 HO
55	355	100	94.3	M3JP/KP 250SMA 4	£9,216	£9,656
60	388	110	93.6	M3JP/KP 225SME 4	£9,922	£10,899 HO
75	485	134	93.8	M3JP/KP 250SMB 4	£11,373	£11,899 HO
75	483	135	94.5	M3JP/KP 280SMA 4	£12,088	£12,647
86	556	153	94.9	M3JP/KP 250SMC 4	£13,648	£14,278 HO
90	580	161	94.7	M3JP/KP 280SMB 4	£16,657	£17,167
110	707	194	95.1	M3JP/KP 280SMC 4	£18,867	£19,376 HO
110	706	194	95.1	M3JP/KP 315SMA 4	£19,037	£19,715
132	848	232	95.4	M3JP/KP 315SMB 4	£23,283	£23,792
160	1027	285	95.3	M3JP/KP 315SMC 4	£25,663	£26,171
200	1285	351	95.6	M3JP/KP 315MLA 4	£33,818	£34,326
250	1604	443	95.9	M3JP/KP 355SMA 4	£42,314	£43,503
315	2021	551	95.9	M3JP/KP 355SMB 4	£53,358	£54,547
355	2280	614	95.9	M3JP/KP 355SMC 4	£60,154	£61,343
400	2565	705	96.3	M3JP/KP 355MLA 4	£67,630	£69,161
450	2884	781	96.7	M3JP/KP 355MLB 4	£75,205	£76,575
500	3204	865	97	M3JP/KP 355LKA 4	£83,235	£84,606
560	3586	982	96.8	M3JP/KP 400LA 4	£94,791	£96,551
560	3586	982	96.8	M3JP/KP 400LKA 4	£94,791	£96,551
630	4035	1084	97	M3JP/KP 400LB 4	£106,711	£110,618
630	4035	1084	97	M3JP/KP 400LKB 4	£106,711	£110,618
710	4547	1235	97.1	M3JP/KP 400LC 4	£110,980	£115,043
710	4547	1235	97.1	M3JP/KP 400LKC 4	£110,980	£115,043

\*JP Exd  
\*KP Exde

HO = High-output design  
† Efficiency full load 100%

# Low voltage AC motors

## Flameproof motors, 80-450, 6 & 8<sup>+</sup> poles

### Exd/e\* IIB T4

TEFC low voltage motors, cast iron, IP55, IC 411, single-speed. 400 V 3-phase 50 Hz  
See product catalogues or [www.abb.com/motors&generators](http://www.abb.com/motors&generators) for more information on products.

Output kW	Torque Nm	Current I	Eff <sup>†</sup>	Frame size	Foot price	Flange price	
<b>1000 r/min = 6 poles</b>							
0.37	3.7	1.29	71.6	M3JP/KP 80MA 6	£784	£853	
0.55	5.6	1.75	70.3	M3JP/KP 80MB 6	£820	£887	
0.75	7.6	2.1	79.2	M3JP/KP 90SLA 6	£855	£911	
1.1	11.3	2.9	78.5	M3JP/KP 90SLC 6	£868	£940	
1.5	15.1	3.7	81.6	M3JP/KP 100LA 6	£940	£1,017	
2.2	22.1	5.5	82.5	M3JP/KP 112MB 6	£1,307	£1,403	
3	29.8	6.9	84	M3JP/KP 132SMB 6	£1,756	£1,839	
4	39	9	85.7	M3JP/KP 132SMC 6	£1,859	£1,924	
5.5	54	12.6	87.5	M3JP/KP 132SMD 6	£1,941	£2,062	
7.5	74	15.9	87.6	M3JP/KP 160MLA 6	£2,400	£2,520	
11	108	21.9	90.1	M3JP/KP 160MLB 6	£3,164	£3,267	
14	138	30.1	89.2	M3JP/KP 160MLC 6	£3,798	£3,875	HO
15	147	29.2	90.5	M3JP/KP 180MLB 6	£4,219	£4,353	
18.5	182	40.1	90.1	M3JP/KP 180MLC 6	£4,767	£4,918	HO
18.5	180	35.9	90.5	M3JP/KP 200MLA 6	£5,052	£5,257	
22	214	42.1	91.6	M3JP/KP 200MLB 6	£5,595	£5,783	
30	291	58.8	90.6	M3JP/KP 200MLC 6	£7,057	£7,242	HO
30	291	57.3	92.2	M3JP/KP 225SMB 6	£7,498	£7,718	
37	359	69.8	91.8	M3JP/KP 225SMC 6	£8,535	£8,778	HO
37	357	71.1	92.2	M3JP/KP 250SMA 6	£9,623	£9,878	
45	436	83.1	93.1	M3JP/KP 250SMB 6	£10,897	£11,151	HO
45	434	83.9	93.4	M3JP/KP 280SMA 6	£12,088	£12,647	
55	531	101	93.8	M3JP/KP 280SMB 6	£16,791	£17,337	
75	723	137	94.2	M3JP/KP 280SMC 6	£16,963	£17,337	HO
75	722	140	94.4	M3JP/KP 315SMA 6	£19,205	£19,715	
90	866	163	94.8	M3JP/KP 315SMB 6	£23,283	£23,792	
110	1060	201	95	M3JP/KP 315SMC 6	£26,852	£27,530	
132	1272	241	95.3	M3JP/KP 315MLA 6	£30,760	£31,442	
160	1539	292	95.4	M3JP/KP 355SMA 6	£37,897	£38,576	
200	1923	364	95.7	M3JP/KP 355SMB 6	£47,240	£48,090	
250	2404	460	95.7	M3JP/KP 355SMC 6	£58,794	£59,816	
315	3032	572	95.7	M3JP/KP 355MLB 6	£74,090	£74,938	
355	3417	661	95.7	M3JP/KP 355LKA 6	£86,367	£87,738	
400	3847	732	96.2	M3JP/KP 400LA 6	£93,798	£97,707	
400	3847	732	96.2	M3JP/KP 400LKA 6	£93,798	£97,707	
450	4323	816	96.6	M3JP/KP 400LB 6	£105,521	£110,106	
450	4323	816	96.6	M3JP/KP 400LKB 6	£105,521	£110,106	
500	4808	895	96.6	M3JP/KP 400LC 6	£117,342	£122,324	
500	4808	895	96.6	M3JP/KP 400LKC 6	£117,342	£122,324	
560	5385	976	96.9	M3JP/KP 400LD 6	£124,444	£129,320	
560	5385	976	96.9	M3JP/KP 400LKD 6	£124,444	£129,320	
610	5860	1098	96.6	M3JP/KP 450LA 6	£126,552	£128,818	
<b>750 r/min = 8 poles</b>							
0.18	2.4	1.07	57.7	M3JP/KP 80MA 8	£785	£853	
0.25	3.4	1.15	61.4	M3JP/KP 80MB 8	£827	£891	
0.37	5.1	1.31	65.5	M3JP/KP 90SLA 8	£847	£919	
0.55	7.6	1.91	68.7	M3JP/KP 90SLC 8	£931	£1,005	
0.75	9.9	2.6	76.5	M3JP/KP 100LA 8	£1,021	£1,098	
1.1	14.6	3.7	75.3	M3JP/KP 100LB 8	£1,332	£1,403	
1.5	20.1	5.3	75.3	M3JP/KP 112MC 8	£1,408	£1,498	
2.2	29.2	6.1	80.3	M3JP/KP 132SMC 8	£1,891	£1,976	
3	40	7.7	79.9	M3JP/KP 132SMD 8	£2,112	£2,177	
4	53	9.8	83.3	M3JP/KP 160MLA 8	£2,282	£2,488	
5.5	73	12.9	86.8	M3JP/KP 160MLB 8	£2,758	£2,859	
7.5	100	18.8	82	M3JP/KP 160MLC 8	£3,284	£3,402	
11	145	25	88.3	M3JP/KP 180MLB 8	£4,272	£4,407	
15	195	30.4	89.9	M3JP/KP 200MLA 8	£5,476	£5,682	
18.5	241	37.3	89.2	M3JP/KP 200MLB 8	£6,291	£6,497	HO
18.5	241	40	90	M3JP/KP 225SMA 8	£6,548	£6,767	
22	287	43.5	90.6	M3JP/KP 225SMB 8	£7,634	£7,991	
30	392	61.2	90.7	M3JP/KP 225SMC 8	£9,199	£9,418	HO
30	390	60.6	91.6	M3JP/KP 250SMA 8	£9,775	£10,251	
37	479	73.3	92.2	M3JP/KP 250SMB 8	£11,051	£11,323	HO
37	477	73.7	91.7	M3JP/KP 280SMA 8	£12,494	£12,886	
45	580	90.4	92.1	M3JP/KP 280SMB 8	£16,896	£17,505	
55	709	107	93.4	M3JP/KP 280SMC 8	£17,505	£17,848	HO
55	708	108	92.4	M3JP/KP 315SMA 8	£19,205	£19,715	
75	966	143	93	M3JP/KP 315SMB 8	£24,132	£24,810	
90	1160	171	93.3	M3JP/KP 315SMC 8	£28,042	£28,721	
110	1419	205	93.6	M3JP/KP 315MLA 8	£32,629	£33,307	
132	1694	255	93.9	M3JP/KP 355SMA 8	£38,066	£39,085	
160	2054	305	94.7	M3JP/KP 355SMB 8	£45,711	£46,901	
200	2574	386	94.5	M3JP/KP 355SMC 8	£57,265	£58,287	
250	3213	477	94.5	M3JP/KP 355MLB 8	£78,337	£79,710	
315	4043	588	96.1	M3JP/KP 400LA 8	£90,230	£93,628	
315	4043	588	96.1	M3JP/KP 400LKA 8	£90,230	£93,628	
355	4562	642	96.2	M3JP/KP 400LB 8	£101,784	£105,521	
355	4562	642	96.2	M3JP/KP 400LKB 8	£101,784	£105,521	
400	5134	737	96	M3JP/KP 400LC 8	£105,477	£109,612	
400	5134	737	96	M3JP/KP 400LKC 8	£105,477	£109,612	
430	5519	789	95.9	M3JP/KP 450LA 8	£114,351	£116,616	
470	6032	862	96	M3JP/KP 450LB 8	£124,982	£127,248	
530	6793	983	96.1	M3JP/KP 450LC 8	£139,104	£141,369	
600	7690	1124	96.3	M3JP/KP 450LD 8	£153,395	£155,663	

\* JP Exd  
\* KP Exde

HO = High-output design

<sup>†</sup> Efficiency full load 100%

\* IE2 not applicable to 8 pole

# Low voltage AC motors

## Optional extras for low voltage AC motors

Please note, ABB general performance motors have limited optional extras (see extras marked with\*).  
Select motor from the ABB process performance range when additional extras are required.

R = On request  
S = Standard  
N = Not available

Option description	Modification code	Motor types	80	90	100	112	132	160	180	200	225	250	280	315	355
			£	£	£	£	£	£	£	£	£	£	£	£	£
Auxiliary terminal box for accessories	418	●	N	N	N	N	N	364	364	364	364	364	364	364	364
	418	■	364	364	364	364	364	364	364	364	364	364	364	364	364
British Standard sliderrails*		●	80	80	115	115	115	157	157	289	289	484	484	890	889
		■	80	80	115	115	115	157	157	289	289	484	484	890	889
Degree of Protection IP56*	403	●	246	246	246	307	307	351	351	351	351	351	351	385	406
	403	■	246	246	246	307	351	351	351	351	351	351	351	385	406
Degree of Protection IP65	158	●	246	246	246	312	312	398	398	398	398	398	350	385	406
	158	■	246	246	246	312	312	398	398	398	398	398	350	385	406
External earth bolt*	67	●	70	70	70	70	70	122	122	122	122	122	119	119	119
	67	■	70	70	70	70	70	122	122	122	122	122	119	119	119
Foot and face mounting*	8	●	130	130	130	169	169	N	N	N	N	N	N	N	N
	8	■	94	94	94	136	N	N	N	N	N	N	N	N	N
Foot and flange mounting*	9	●	130	130	130	169	169	322	322	427	427	467	402	696	1215
	9	■	94	94	94	136	136	285	285	380	380	414	402	696	1215
Frequency converter rating plate. Rating data according to quotation	163	●	72	72	72	72	72	72	72	72	72	72	72	72	71
	163	■	72	72	72	72	72	72	72	72	72	72	72	72	71
Heating element specify 120 V or 240 V*	450/451	●	234	234	234	261	261	315	349	388	444	533	474	474	530
	450/451	■	234	234	234	261	261	315	349	388	444	533	474	474	530
Insulated bearing at NDE. Frame 280 and above on variable-speed drives.*	701	●	R	R	R	R	R	R	R	R	R	R	1127	1127	1560
	701	■	R	R	R	R	R	R	R	R	R	R	1127	1127	1560
Metal fan	68	●	150	150	150	210	210	303	303	326	342	342	550	589	626
	68	■	145	145	145	208	208	269	269	287	303	303	550	589	626
Metal fan cover	53	●	100	100	100	139	137	S	S	S	S	S	S	S	S
	53	■	S	S	S	S	S	S	S	S	S	S	S	S	S
Paint colour to standard RAL specify RAL no.*	114	●	215	215	215	210	210	257	257	257	257	257	250	250	249
	114	■	215	215	215	210	210	257	257	257	257	257	250	250	249
PT100 resistance element one per phase	445	●	N	N	N	634	634	623	623	922	922	922	869	869	868
	445	■	R	R	R	634	634	623	623	922	922	922	869	869	868
PTC thermistors, three in series, 150°C others on request*	436	●	131	131	131	169	169	246	246	246	246	246	212	212	212
	436	■	131	131	131	169	169	246	246	246	246	246	212	212	212

# Low voltage AC motors

## Optional extras for low voltage AC motors

Please note, ABB general performance motors have limited optional extras (see extras marked with\*).  
Select motor from ABB process performance range when additional extras are required.

R = On request  
S = Standard  
N = Not available

Option description	Modification code	Motor types	80 £	90 £	100 £	112 £	132 £	160 £	180 £	200 £	225 £	250 £	280 £	315 £	355 £
Rain canopy for VI mounting*	5	●	111	111	111	127	127	145	167	175	235	290	349	412	614
	5	■	111	111	111	127	127	145	167	175	235	290	349	412	614
Restamping voltage, frequency and output, continuous duty*	2	●	51	51	51	51	51	51	51	51	51	51	51	51	51
	2	■	51	51	51	51	51	51	51	51	51	51	51	51	51
Roller bearing at DE (not available on IIC motors)*	37	●	N	N	N	N	N	257	295	335	386	427	367	367	536
	37	■	N	N	N	N	N	257	295	335	386	427	367	367	536
Separate (fixed speed) motor cooling fan	183	●	382	382	382	927	927	1151	1311	1837	2160	2519	N	N	N
	158	■	R	R	1010	1213	1513	1622	1622	1622	1908	2226	2409	3030	3289
SPM nipples	43	●	N	N	N	155	155	261	293	327	337	337	329	329	329
	43	■	N	N	N	N	N	261	293	327	337	337	329	329	S
Test - routine*	148	●	208	208	208	236	236	236	236	236	236	236	236	236	235
	148	■	208	208	208	236	236	236	236	236	236	236	236	236	235
Test - Type test report from test of an identical motor (where available)*	145	●	88	88	88	88	88	88	88	125	125	125	176	176	176
	145	■	88	88	88	88	88	88	88	125	125	125	176	176	176

Alloy ●  
Cast Iron ■

# Low voltage AC motors

## NEMA motors

### General purpose industrial motors

#### Three-phase, totally enclosed, foot mounted

- 1/8 – 400 HP
- NEMA 42 – 449T



### Applications

Pumps, compressors, fans, conveyors, machine tools and other general purpose three-phase applications.

### Features

Suitable for mounting in any position. Ball bearings, heavy-gauge steel and cast-iron frames, and gasketed conduit boxes. Class F insulation, 1.15 service factor, low-loss electrical grade lamination steel. EM Super-E® motors have NEMA Premium® efficiency and three years warranty. Motors with TR suffix have roller bearings for heavy belted loads.

### Severe duty motors

#### Three-phase, totally enclosed, foot mounted

- 1 – 400 HP
- NEMA 143T – 449T



### Applications

Petrochemical plants, mines, foundries, pulp and paper plants, waste management facilities, chemical plants, tropical climates and other processing industry applications requiring protection against corrosion caused by severe environmental operating conditions.

### Features

ECP motors are XEX designs. 1.15 service factor, corrosion resistant epoxy finish, regreasable ball or roller bearings, oversized rotatable cast iron conduit box, cast iron frames, V-ring shaft seal, moisture resistant copper windings. Class F insulation, stainless steel nameplate and corrosion resistant hardware. ECP/XEX Super-E® motors have NEMA Premium® efficiency and three years warranty. Positive lubrication system (PLS) on 360 frames and larger.

### Explosion-proof motors

#### Single and three-phase, foot mounted

- 1/4 – 300 HP
- NEMA 48 – 449T



### Applications

Ideal for use where hazardous fumes or dust may be present.

### Features

UL and CSA approved for Division 1, Class I, Group D; Class I, Group D, Class II Group F & G; Class I, Group C & D, Class II, Group F & G. Corrosion resistant epoxy finish. Shipped with UL- and CSA approved cast conduit box assembled to each motor. 1.00 service factor. EM Super-E® explosion proof motors have NEMA Premium® efficiency and three years warranty.

# Low voltage AC motors

## Central motor stock, Mod Express® line, Menden, Germany

ABB's European logistics centre in Menden, Germany offers customers on-time and just-in-time delivery on a wide range of ABB products.

The 23,000 square metre facility has 45,000 automated parts bins and stocks over 2.5 million ABB items including parts and accessories.

NEMA motors are in stock at the facility and include:

- NEMA general purpose
- ECP XEX severe duty
- IEEE841 totally enclosed severe duty and speciality motors.

NEMA general purpose TEFC motors are basic protection motors used on pump and fan applications and have a protection similar to the European IP44 rating.

The NEMA ECP XEX severe duty TEFC motors are suited to tougher industrial operating environments and are protected similar to IP54.

The IEEE841 specification, totally enclosed severe duty motors are protected similar to IP56.

Among those motors stocked in Menden are 2-pole and 4-pole variants, with various mounting styles available including foot mounted, C-face mounted and C-face footless options. The speciality motors include a selection of Baldor permanent magnet DC motors.

NEMA motors are now available within 48 hours from ABB's central European stockholding in Germany.

### NEMA general purpose motors

- 1/3 through 250 HP, 0.25 kW to 187 kW

### NEMA general purpose motors

- 1/3 through 250 HP, 0.25 kW to 187 kW

### IEEE841 standard severe duty motors

- 1 through 250 HP, 0.75 kW to 187 kW

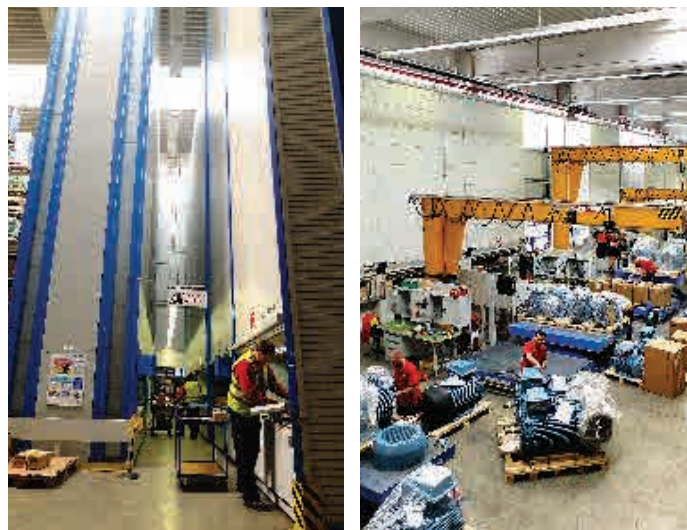

Modifications to NEMA motors, certified to CSA standards, can be carried out by ABB at its European logistics centre in Germany for distribution across Europe.

The motor build centre, called the Mod Express® line, carries out modifications to NEMA general purpose, severe duty and IEEE 841 severe duty motors held in stock. General purpose and IEEE severe duty motors are available with foot mount, C-face foot and C-face footless options and severe duty motors stocked with foot mounted options.

ABB's European logistics centre in Germany is fully equipped with a secure storage facility, access to fast-track air freight dispatch and has an export packaging option through the Mod Express® line, giving an all-in-one facility for immediate NEMA motor dispatch.

A dedicated exports team ensure that all the correct paperwork is supplied with the motor to allow on-time delivery worldwide without Customs delays.

ABB is the only supplier able to deliver a customised NEMA motor from local stock with full accreditation to CSA anywhere in the world.

The modifications available for these motors include:

- Installation of thermistors
- Thermal protection sensors
- Bearing upgrades
- Conduit box modifications
- Tropicalisation
- Customised paint finishes
- Nameplate modification

# AC motors

## High voltage

### Overview

Engineered rib-cooled motor NXR

- 100 kW to 1,800 kW
- 315 to 500 frame size
- New platform for HV rib-cooled motors
- High efficiency levels, low noise levels
- Fixed-speed, variable-speed and safe area use



Engineered rib-cooled motor HXR

- 100 kW to 2,250 kW
- 355 to 560 frame size
- High efficiency levels, low noise levels
- Fixed-speed, variable-speed and hazardous area use





# AC motors

## High voltage

### Overview



#### Modular induction motors

- Built from the basic design by using modular construction
- Complete range of enclosures and cooling arrangements
- Optimal weight to power ratio
  - 140 kW to 23,000 kW
  - 400 – 1000 frame size

#### Flameproof motors Ex d

- Motor intended for explosive atmosphere
- Protection category according to EN/IEC Flameproof Ex d, Ex de
- Totally-enclosed, fan-cooled
- Cooling methods: IC411 and IC511
- Both cast-iron and welded steel frame available
- Certified according to ATEX directives, IEC, EN and NEMA standards and all major local requirements
- Suitable for variable-speed drives
  - 160 kW to 8,000 kW
  - 355 – 900 frame size





# Motors and generators service and PC tools

<a href="#">MotorAdvantage</a>	<a href="#">108</a>
<a href="#">DriveSize &amp; MotSize</a>	<a href="#">109</a>
<a href="#">Optimizer, ABB MACHsense-P</a>	<a href="#">110</a>
<a href="#">ABB MACHsense-R and LEAP</a>	<a href="#">111</a>

# Motors and generators service and PC tools

## MotorAdvantage

MotorAdvantage aims to encourage industry to uncover the true cost of running electric motors. Research by ABB reveals that UK industry is failing to efficiently manage its motor inventory, thereby incurring millions of pounds of unnecessary downtime, repair and energy costs.

MotorAdvantage is aimed at companies operating a continuous process such as those found in food & beverage, chemical, oil & gas and pharmaceuticals. Such processes tend to have critical applications, whereby if a motor fails the cost to a company can be hundreds of pounds per hour in lost revenue. It is not just the loss of production but the potential loss of the company's customer.

### How it works

There are three stages to MotorAdvantage:

#### 1. Consultation

During the consultation process ABB examines the installed motor asset register for the plant and, working with the local engineers, identifies up to five critical applications that are running either continuously or for more than 4,000 hours per annum. They then determine some basic information about these motors such as:

- How old are the installed motors?
- How efficient are the installed motors?
- How many hours do they run per annum?
- Have they been rewound before?
- What spares holding do you have for critical plant?
- What is your repair/rewind policy for 'failed' motors?

ABB also engages with the plant's process engineers to determine the exact design criteria for the various processes. This gives ABB a clearer understanding of how the process is meant to operate and its critical design operating points, thereby ensuring that a properly dimensioned motor is selected should a replacement be deemed necessary.

#### 2. The Appraisal

An ABB engineer, or one of ABB's Authorised Value Providers partners, visits the end-user to inspect the selected motors, get an understanding of the plant, the inventory of spare motors, energy and maintenance plans. It is not unusual to find that an old motor can be 1-5 percent lower in efficiency compared to a new premium efficiency variant. If that motor is running continuously then you can achieve a typical payback of between two to three years should you wish to take the decision to scrap the motor prior to failure.



If the motor is replaced at the point of failure then taking the rewind cost into the payback calculation, the new motor cost can be recovered in less than 12 months. Bear in mind that many rewound motors will only have a six month warranty of the repaired components whilst a new premium efficiency motor from ABB comes with a three year warranty.

#### 3. Proving the savings – report and recommendations

Following the collection of the data, the findings are analysed and potential savings identified using dedicated software. The findings are methodically presented, with tables being created to help identify where savings are likely to arise. Among the data available includes an estimation of present energy usage; whether the application would benefit from variable-speed control; payback time if an investment is made in new motors; carbon dioxide emission reductions; along with many other key facts and analysis.

An action plan is prepared, usually comprising an Executive Summary and a detailed Engineer's Report, highlighting applications that can save the most. The figures will normally be translated into monthly savings, and there will be detailed recommendations for implementation.

#### Benefits

- In just half-a-day, an ABB engineer can assess up to five installed motors that could benefit from a motor management plan
- Examines the end-users current policy in the event of a motor failure and the financial impact on the company
- Identifies improvements to be made with regards to maintenance and stockholding
- Determines the energy use of the current installation

# Motors and generators service and PC tools

## DriveSize & MotSize

### DriveSize

DriveSize is a software tool that helps users select an optimum motor, drive and transformer especially for applications where straightforward selection from a catalogue is not possible.



DriveSize can also compute current, network harmonics and create dimensioning documents based on actual load parameters. DriveSize is available to use online via the ABB website or can be downloaded for use on a PC. For system requirements see:

<http://new.abb.com/drives/software-tools/drivesize>

DriveSize contains a current version of the ABB motor and drives catalogue and allows users to import their own motor database. The default values make DriveSize simple to use with ample options for drive selection.

#### The software performs dimensioning based on the following input:

- Speed range and mechanical load with overloads
- Ambient temperature and altitude
- Required IP-class and allowed temperature rise
- Supply network characteristics
- Load type and duty cycle
- Optionally current requirements for inverter unit
- Optionally current requirements for inverter unit Optionally current
- Apparent power requirement for the transformer

#### The software enables you to:

- Calculate the network harmonics of individual drive or set of drives
- Obtain efficiency values
- See your selection in graphical or numeric form
- Select manually an optional unit from database
- Print reports in Excel
- Save the results into XML project files
- Import your own motor database

#### Benefit

- Select an optimal motor, frequency converter and transformer
- Dimensioning based on actual shaft load
- Documents dimensioning results, graphical and numerical presentation
- Network harmonic and power factor calculation
- Print and save the results

### MotSize

MotSize is a selection tool that helps users to select an optimal direct-on-line (DOL) motor from the low voltage motors catalogue. Additionally, MotSize allows users to dimension motors for specific application requirements.

### MotSize functions

The software performs dimensioning based on the following data:

- Ambient conditions
- Altitude
- Requirements for a temperature rise
- Supply network data
- Load type and duty cycle

The following single-speed and/or two-speed motor types are included:

- General purpose motors:
  - Aluminium, cast iron, steel, open drip proof, brake
- Process performance motors:
  - Cast iron, aluminium
- Marine motors:
  - Aluminium, cast iron, steel, open drip proof
- Hazardous area motors:
  - Non-sparking aluminium, cast iron motors
  - Increased safety aluminium, cast iron motors
  - Flameproof cast iron motors
  - Dust ignition proof aluminium, cast iron motors

The software can handle imperial as well as metric units, all technical data is updated regularly.

The software also enables you to:

- Specify starting conditions
- Rest current, power, voltage and frequency
- Obtain rating data as well as data with partial load
- Choose the language for the printouts
- Print-out technical data sheets and graphs

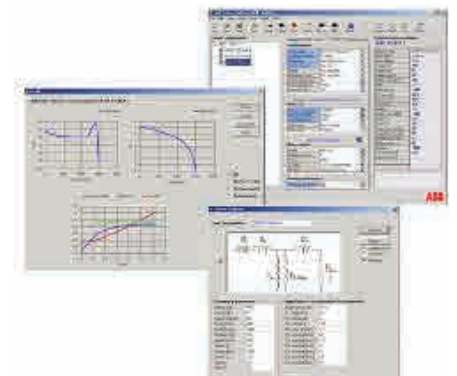

# Motors and generators service and PC tools

## Optimizer, ABB MACHsense-P

### Optimizer

ABB's Optimizer is an online tool that can quickly select the optimum motor for any minimum energy performance standard (MEPS) worldwide.

Motor users can select motors, compare running costs and get further documents about their motors and work out the cost of ownership.

Optimizer gives users eight drop down selection menus.

1. MEPS area (e.g. EU, United States)
2. Efficiency class (IE2, IE3 etc)
3. Frame material
4. Motor range
5. Voltage
6. Frequency
7. Speed
8. Power output



Once the required characteristics are selected, the tool presents a list of suitable motors. Selecting EU MEPS, IE3, dust ignition proof motors, 400 V, 50 Hz, all poles and outputs, returns a list of 49 suitable motors. They can be compared by running cost, payback periods, life cycle savings and reduction in greenhouse gas emission.

Optimizer automatically suggests, a higher efficiency motor and highlights savings realised by upgrading. Test reports, drawings, data sheets and other documents can be accessed quickly and easily for the selected motors. Documents can be opened on screen, saved or exported as a zip file.

Optimizer can be downloaded from the Apple store for iPad use by searching for 'ABB Optimizer'.

For more information about Optimizer call the ABB motors team on **07000 MOTORS**, that's **07000 668677**

### ABB MACHsense-P

**Regular health checks help to maintain maximum performance over entire life cycle**

ABB MACHsense-P is a condition monitoring service that addresses the reliability of the complete shaft line, including the motor, gearbox and driven load (pump, fan or compressor). It identifies electrical and mechanical issues related to the rotor, bearings, gearbox and other components – problems which account for a major percentage of total failures.

#### Key benefits:

- Instant summary report, with a full report after detailed analysis
- Earlier warnings and more comprehensive diagnosis than conventional solutions
- Vibration and electrical measurements are processed in a single software platform to avoid false positives and negatives
- Advanced software delivers a high degree of accuracy
- Collection of vibration data over wider frequency range covers greater number of potential problems
- Testing is done with the motor in its operating condition, so no preparatory work is necessary
- Optimised cost of ownership

# Motors and generators service and PC tools

## ABB MACHsense-R and LEAP

### ABB MACHsense-R

#### Continuous, remote monitoring with instant alarms and expert follow-up

ABB MACHsense-R continuously monitors key condition parameters specific to the type of motor being monitored. ABB MACHsense-R can identify nascent fault conditions at an earlier stage than conventional methods. Shaft line monitoring can be implemented with MACHsense-R.

Customers can access operating data and trend graphs via the internet. An alarm is triggered if a measured parameter exceeds set limits, giving the plant operator an early warning that maintenance is needed.

#### Key benefits:

- Motor or generator is constantly monitored during operation
- Model based analysis increases reliability of defect identification and quantifies defect severity
- Motor and generator design and construction taken into account for higher precision
- Multi-channel operation and fast data collection rates increase sensitivity
- On-board processing reduces volume of data transmitted to server for lower communication costs
- Authorised customers can quickly access motor or generator specific data on ABB's server
- Customers can receive regular reports on condition of their motors and generators
- Unplanned downtime is reduced, resulting in optimised cost of ownership

### ABB LEAP

#### Life Expectancy Analysis Program (LEAP) for motors and generators

ABB Life Expectancy Analysis Program or ABB LEAP is a diagnostic tool for assessing the condition of the stator winding insulation in electric machines.

ABB LEAP goes further than conventional health monitoring programmes for rotating electrical machines, which typically use green, yellow and red LEDs, or similar to express the results. ABB has evolved this methodology to a new level: ABB LEAP analysis provides precise information on the remaining lifetime of the stator winding. Based on this, specific service actions can be planned well ahead. This method drastically reduces unplanned shutdowns caused by the failures due to factors such as thermal, electrical, ambient, or mechanical aging.



#### Key benefits:

- Optimises maintenance planning for electrical machines by moving from time based to condition based maintenance
- Supports efforts to extend machine lifetime, boosting return on investment (ROI)
- Facilitates decision making for short and long term maintenance and run-replace decisions
- Minimises unplanned downtime and reduces risk levels
- Provides information for lifecycle cost estimation

#### Condition monitoring solution for low voltage motors

ABB's smart sensor picks up data on vibration, temperature and other parameters and uses it to reduce motor downtime by up to 70 percent, extend lifetime by as much as 30 percent and lower energy use by up to 10 percent. The compact sensor that is attached to the frame of low voltage induction motors. No wiring is needed. Utilising Cloud based analytics, the smart sensor relays information about the motor's health, via a smartphone and over the internet, to a secure server. Historical information and trends are visible from a dedicated customer portal that provides status information on the entire population of motors that have been smart enabled.

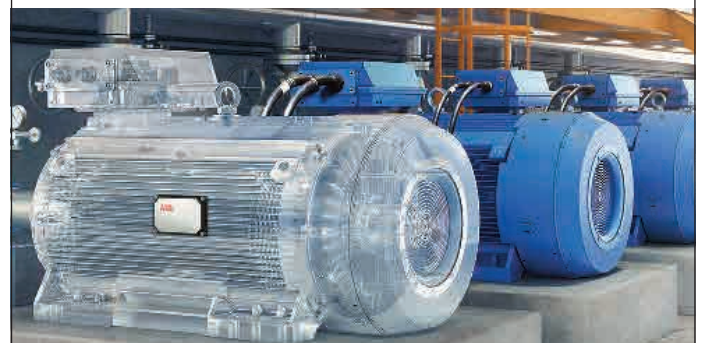





# Mechanical power transmission

<a href="#">Gearings</a>	<a href="#">114</a>
<a href="#">Mounted bearings</a>	<a href="#">115</a>
<a href="#">Roller bearings</a>	<a href="#">116</a>
<a href="#">Couplings</a>	<a href="#">117</a>

# Mechanical power transmission

## Gearings

For well over a century, Dodge products have helped manufacturers, OEMs and producers increase the productivity and profitability of their operations.

ABB has added new warehouse space to stock Dodge mechanical power transmission products, which ensures they are quickly accessible when you need them.

### Torque-Arm II



- All reducers can be shaft mounted: screw conveyor, vertical, and flange mounted
- Up to 294 kW
- Up to 56,500 Nm
- Standard 5, 9, 15, 25, and up to 40:1 gear ratios
- Nearly 300:1 speed reduction with V-belt drives
- Twin-tapered bushing bores: 25 mm through 160 mm
- Highly efficient helical gearing
- Meets or exceeds AGMA standards, including 5,000 hours L10 life and 25,000 average hour life
- New heavy duty lip seals for extended wear life, -40 - 138°C
- 100 percent factory noise and leak tested
- New metal shield sealing system with excluder lip
- AGMA output torque ratings up to 56,500 Nm

### Quantis



- Inline helical (ILH), right angle helical bevel (RHB), motorised shaft mount (MSM)
- 0.75 kW - 56 kW up to 14,000 Nm
- Ratios, 1.5:1 - 300:1
- 8 case sizes per housing configuration, clamp collar, 3-piece coupled, integral gearmotor, separate input. Solid, straight hollow output – ILH/MSM efficiency of 98 percent per stage, RHB efficiency of 95 percent per stage
- All units shipped filled with oil from the factory and are installation ready
- Optional XT harsh duty seal for operation in wet and dirty environments
- Class 30 grey iron housings cast with internal ribbing for added strength
- Options include washdown and screw conveyor configurations

### MagnaGearXTR®



- Parallel shaft or right angle configurations available
- Torque capacities from 32 - 104 kNm available
- Global product design to fit all markets
- Multiple mounting configurations available (base mounting, swing base mounting, tunnel housings)
- Can be used with a variety of soft start mechanisms including VSD and fluid couplings

# Mechanical power transmission

## Mounted bearings

When it comes to reliable service and low maintenance, ABB Dodge® mounted ball bearings are unmatched in the industry. ABB Dodge mounted ball bearings are available in any of our proven locking devices: our exclusive 65° setscrew locking

### Setscrew ball bearings



system, our patented Grip Tight adapter mounted, eccentric locking collars and D-Lok™ concentric clamp locking system mounted ball bearing.

- Superior 65° locking setscrew
- DualGuard seal – comprised of single lip seal and rubberised flinger
- Stronger, more flexible bearing cage
- Optimum balance between locking forces
- Heat stabilised nylon construction with an inner ring stress fiber-glass reinforcement
- Secure fit to the shaft

### Grip Tight® ball bearings



- Two types: normal duty GT and medium duty GTM
- DualGuard seal – comprised of single lip seal and rubberised flinger
- Thin wall adapter mounting offers 360° full shaft contact and concentricity. No shaft
- Marring or fretting corrosion like setscrew and eccentric collar products. Integral dismount feature easily removes the bearing from the shaft. Turned, ground and polished shafting is not required
- Anti-rotation device prevents insert rotation associated with heavy loads, vibration, unbalanced loads and high-speed applications
- High-temperature option available to 204 °C
- Plus or minus 2° static misalignment

### Ultra Kleen®, E-Z Kleen®



- Reinforced polymer and stainless steel housings
- Patented polymer housing includes antimicrobial agent which resists bacterial and fungus growth - two inserts: corrosion resistant and stainless steel insert
- Three locking devices: 65° setscrew angle (SC), Grip Tight adapter mount and concentric clamp collar (D-Lok).
- Quadguard seal: comprised of our triple lip seal and rubberised flinger. Additional grease retention provided by the maxlife cage
- Anti-rotation device prevents insert rotation associated with heavy loads, vibration, unbalanced loads and high-speed applications - plus or minus 2° static misalignment

# Mechanical power transmission

## Roller bearings

For decades, industry's leading producers have depended on ABB Dodge® roller bearings to handle their conveyance and power transmission needs. ABB Dodge bearings

offer innovative designs; a wide range of shaft attachment methods, rolling elements, housings and seal choices, patented features and consistent performance.

### ISN spherical roller bearings



- The only push/pull adapter mount system
- Available in two-bolt pillow blocks
- Accepts commercial shaft tolerances
- Installation and removal in fewer than 15 minutes
- Fully concentric shaft attachment with adapter sleeve mount
- Virtually eliminates fretting corrosion
- Capable of withstanding static or dynamic misalignment of  $\pm 1^\circ$  - shaft-ready out of the box - available with Trident triple lip or labyrinth seal options
- Sizes range from 30 mm through 170 mm
- SN mounting dimensions

### Type E-xtra® tapered roller bearings



- Tapered rolling elements
- Completely assembled, factory adjusted and properly lubricated
- Shaft ready
- Extra protection
- E-Tect seal option - comparable mounting dimensions with ball bearings
- E-xtra allows easy upgrade from ball bearings

# Mechanical power transmission

## Couplings

### Elastomeric, sleeve style - ABB Dodge D-Flex couplings



Three-way flexing action handles shock, vibration and misalignment. The ABB Dodge D-Flex™ coupling features moulded, non-lubricated, interchangeable elastomeric sleeves of EPDM, neoprene Hytrel. Its three-way flexing action accommodates torsional, angular and parallel misalignment, as well as axial end float.

### Elastomeric, tyre style - ABB Dodge Para-Flex



ABB Dodge Para-Flex elements are manufactured with reinforcing fabric tension cords that transmit much of the torque during operation.

The uniform and centred bead in the foot of the tyre element prevents it from pulling out during operation. Additionally, the tyre element is reinforced at the split to reduce fatigue and extend life.

ABB Dodge Para-Flex elements provide accommodation of shaft misalignment during installation, running-time and replacement better than other elastomeric elements.

With an industry-leading combined 4° angular, 3.17 mm (1/8 in.) parallel and 7.93 mm (5/16 in.) end-float capability, Para-Flex couplings will perform in difficult applications and reduce valuable time needed for installation and maintenance.

### Metallic, grid style - ABB Dodge Grid-Lign

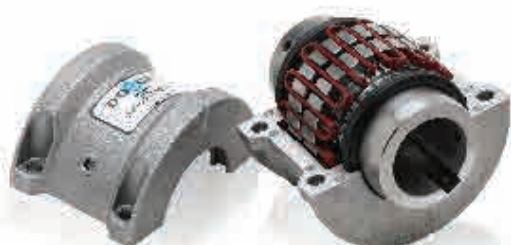

Compact in size, yet high in torque capability, ABB Dodge Grid-Lign couplings are available in a variety of sizes, in standard and spacer styles. Every coupling features two steel shaft hubs, a tapered grid element, two seals and a cover assembly. Its versatile design allows for a motor or reducer output speed connection and its speed capability ranges up to 6,000 rpm dependant on size. ABB Dodge Grid-Lign is available in T31 and T35 spacer designs up to size 1200T. This spacer offering can be used as a spacer coupling, or mounted to a brake disc or drum.

The ABB Dodge Grid-Lign coupling's tapered grid element is engineered with high-strength, spring steel that is quenched and tempered. This feature helps isolate vibration and cushions shock loads. In addition, it allows uniform contact during light, normal and shock-loading conditions for long machine life.

# Useful engineering information

Reference information and explanation of abbreviations

## Degrees of protection

As defined by IEC34-5 and BSA999 pt 105, the code generally consists of 'IP' followed by two digits: the first describing the protection against solid bodies or protection to persons against contact with live or moving parts inside the enclosure; the second describing the protection against ingress of water.

First Digit	Meaning (Protection Against)	Second Digit	Meaning (Protection Against)
0	Not protected	0	Not protected
1	50mm dia. body	1	Vertical drips
2	12mm dia. body	2	Drips up to 15° from vertical
3	2.5mm dia. body	3	Drips up to 60° from vertical
4	1mm dia. body	4	Splashing from any direction
5	Dust protected	5	Water jets from any direction
6	Dust tight	6	Heavy seas (Does not cover corrosion resistance etc)
		7	Effects of immersion

## Cooling forms

As defined by IEC34-6 and BS4999 pt.106, the code generally consists of 'IC' followed by two digits; the first describing the cooling circuit arrangement; the second describing the method of supplying power to circulate the coolant. Where more than one cooling circuit is in use, these may be expressed as 'IC' followed by groups of two digits, e.g. IC0141.

The following forms are used in this catalogue:

- IC410 – Typical examples are roller table motors
- IC411 – Standard motors
- IC416 – Standard motors (normally bigger frame sizes only equipped with auxilliary fan)
- IC418 – Fan application motors without a cooling fan, cooled by the air stream of the driven machine
- IC01 – Open drip-proof motors
- IC31W – Water cooled motors

## Mounting forms

The arrangements are defined by IEC34-7, BS4999 pt. 107 code II (and DIN42950). The following forms are used in this catalogue and are for motors with two bearings housed in end-shields. When flange mounting they have access to the back of the flange.

- IM1001 (B3) Horizontal foot mounted
- IM1011 (V5) Vertical foot mounted
- IM3001 (B5) Horizontal flange mounted
- IM3011 (V1) Vertical flange mounted
- IM2001 (B35) Horizontal foot & flange mounted
- IM1071 (B8) Horizontal foot, ceiling mounted

## Note for gearbox users – service factor

The geared motors covered by this catalogue are rated for driven machines with a uniform load for continuous duty or occasional moderate shock loading on single-shift operation, being known as a Unity Service Factor. For applications with short-time duty, high inertia or heavy shock loads, advice should be sought on calculating the correct service factor and selecting the most suitable gearbox type.

## Abbreviations

Electrical data	
Kilowatt	= kW
Volts	= V
Armature Volts	= Va
Field Volts	= Vf
Amperes	= A
Armature Current	= Ia
Field Current	= If
Power factor	= PF

## Useful conversion factors

1hp	= 746W
1Nm	= 8.851 lb.in
1mm	= 0.03937inch
1m <sup>2</sup>	= 10.765ft <sup>2</sup>
1kg.m <sup>2</sup>	= 1Nms <sup>2</sup> = 0.73752 lb.ft <sup>2</sup>

## Useful formulae

1 Watt	= 1 Nm/s
Torque (lb ft)	= $\frac{5250 \times \text{hp}}{\text{speed (rpm)}}$
Torque (Nm)	= $\frac{9550 \times \text{kW}}{\text{speed (rpm)}}$
3 phase AC power (kW)	= $\frac{1.732 \times V \times I \times \text{PF}}{1000}$
1 phase AC power (kW)	= $\frac{V \times I \times \text{PF}}{1000}$

## Useful servo drive calculations

Correctly rating a servo motor and drive application often involves mechanical calculations. Overleaf are typical examples of some of the commonly occurring formula that are often encountered. These are provided for general guidance only and any results may need to be modified to take into account specific application details such as mechanical losses, inclined angles and duty cycles etc.

# Useful engineering information

Reference information and explanation of abbreviations

## Time to accelerate a rotating mass

$M(\text{acc})$  = Accelerate torque, Nm  
 $J(\text{tot})$  = Total inertia,  $\text{kgm}^2$   
 $J(\text{mot})$  = Motor inertia,  $\text{kgm}^2$   
 $J(\text{load})$  = Load Inertia,  $\text{kgm}^2$   
 $Z$  = Gearbox ratio (speed reducing)  
 $t(\text{acc})$  = Acceleration time, sec  
 $\alpha$  = Angular acceleration,  $\text{rad}\cdot\text{sec}^{-2}$   
= Angular speed,  $\text{rad}\cdot\text{sec}^{-1}$   
 $n$  = Angular speed, rpm

$$M(\text{acc}) = J(\text{tot}) \times \alpha \text{ or } \alpha = M(\text{acc})/J(\text{tot})$$

$$\alpha = \omega/t(\text{acc}) \text{ or } t(\text{acc}) = \omega/\alpha$$

$$\omega = (n/60) \times 2\pi$$

$$J(\text{tot}) = J(\text{mot}) + (J(\text{load})/Z^2)$$

## Example

$J(\text{load}) = 0.05 \text{ kgm}^2$   
 $J(\text{mot}) = 5.0 \text{ kgcm}^2 (= 0.00050\text{kgm}^2)$   
 $Z = 30:1$   
 $n = 1500 \text{ rpm}$   
 $M(\text{acc}) = 15 \text{ Nm}$

$$J(\text{tot}) = 0.00050 + (0.5/30^2)$$

$$J(\text{tot}) = 0.00106 \text{ kgm}^2$$

$$\alpha = M(\text{acc})/J(\text{tot})$$

$$\alpha = 15/0.00106$$

$$\alpha = 14,150 \text{ rad}\cdot\text{sec}^{-2}$$

$$\omega = (1500/60) \times 2\pi$$

$$\omega = 157 \text{ rad}\cdot\text{sec}^{-1}$$

$$t(\text{acc}) = \omega/\alpha$$

$$t(\text{acc}) = 157/14,150$$

$$t(\text{acc}) = 0.0111 \text{ sec (11.1mS)}$$

## Useful inertia formula

Servo drives are often employed in highly dynamic applications where rapid and accurate positioning is required. To obtain the ultimate performance in any system, the reflected load inertia (taking into account any gearbox or pulley ratios) should equal the motor inertia. This is often not possible, but ratio mismatches of typically 5:1 are not normally significant. The greater this mismatch between reflected load inertia and motor inertia, the lower will be the dynamic performance of the system.

## Solid cylinder rotating about axis XX

$$J = (mR^2)/2$$

## Hollow cylinder rotating about axis XX

$$J = m(R^2 + r^2)/2$$

## Equivalent inertia of slide mass on a ballscrew

$$J = m(s/2\pi)^2$$

## Effect of gear ratio on reflected inertia

$$J = J(\text{load})/Z^2$$

## Torque required to produce a force on a leadscrew

$M$  = Required torque, Nm

$F$  = Linear force, N

$Z$  = Gearbox ratio (speed reducing)

( $Z = 1$  for direct drive)

$s$  = Ballscrew pitch, m

$\eta$  = Efficiency

$$M = Fs/2\pi R\eta$$

## Example

$F = 10,000 \text{ N}$

$s = 10 \text{ mm (0.01m)}$

$Z = 2:1$

$\eta = 0.9$

$$\begin{aligned} \text{Required motor torque } M &= (10,000 \times 0.01)/ \\ & (2\pi \times 2 \times 0.9) \\ &= 8.85 \text{ Nm} \end{aligned}$$

NB: The required force is often provided in kg's or kgf. This implies the force exerted on the mass by gravity ( $g$ ) and must be multiplied by 9.81 to obtain the force in N (newtons); eg A "force" of 100 kg is 981 N.

# Contact us

## **ABB Limited**

Daresbury Park

Daresbury

Warrington

Cheshire

WA4 4BT

Tel: +44 (0) 1925 741 111

Fax: +44 (0) 1925 741 212

**[www.abb.co.uk/energy](http://www.abb.co.uk/energy)**

## Note

We reserve the right to make technical changes or modify the contents of this document without prior notice. The prices contained within this document are indicative at the time of publication and are subject to validation at the time of purchase. With regard to purchase orders, the agreed particulars shall prevail. ABB does not accept any responsibility whatsoever for potential errors or possible lack of information in this document.

We reserve all rights in this document and in the subject matter and illustrations contained therein. Any reproduction, disclosure to third parties or utilization of its contents – in whole or in parts – is forbidden without prior written consent of ABB.

Copyright© 2017 ABB - All rights reserved

Printed in the UK